

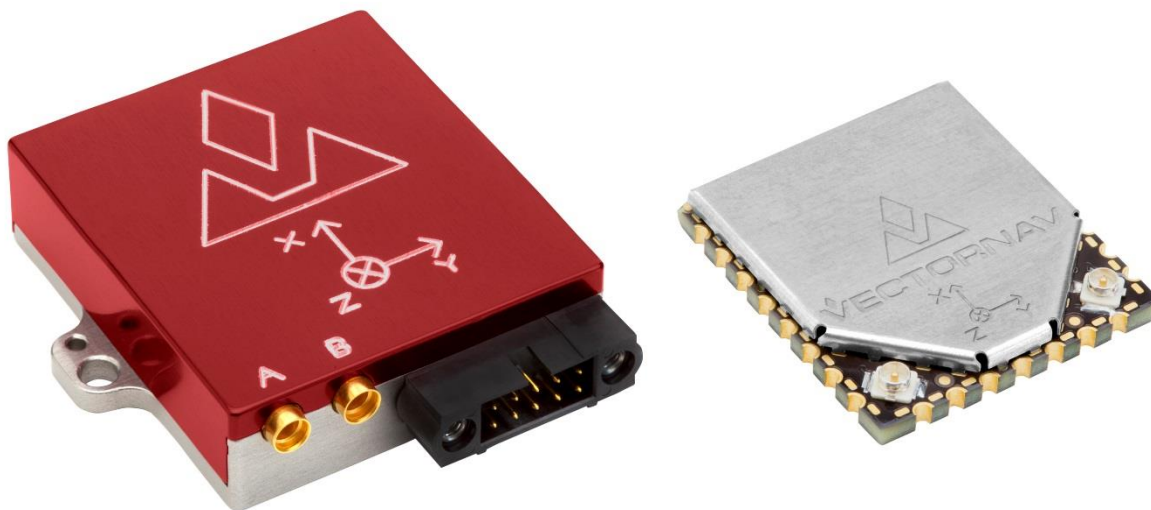

Embedded Navigation Solutions

VN-300 User Manual



Firmware v0.5.0.1

Document Revision 2.43

Document Information

Title	VN-300 User Manual
Subtitle	Inertial Navigation Modules
Document Type	User Manual
Document Number	UM005 v2.43
Document Status	Released

VectorNav Technical Documentation

In addition to our product-specific technical data sheets, the following manuals are available to assist VectorNav customers in product design and development.

- **VN-300 User Manual:** The user manual provides a high-level overview of product specific information for each of our inertial sensors. Further detailed information regarding hardware integration and application specific use can be found in the separate documentation listed below.
- **Hardware Integration Manual:** This manual provides hardware design instructions and recommendations on how to integrate our inertial sensors into your product.
- **Application Notes:** This set of documents provides a more detailed overview of how to utilize many different features and capabilities offered by our products, designed to enhance performance and usability in a wide range of application-specific scenarios.

Document Symbols

The following symbols are used to highlight important information within the manual:



The information symbol points to important information within the manual.



The warning symbol points to crucial information or actions that should be followed to avoid reduced performance or damage to the navigation module.

Technical Support

Our website provides a large repository of technical information regarding our navigation sensors. A list of the available documents can be found at the following address:

<http://www.vectornav.com/support>

If you have technical problems or cannot find the information that you need in the provided documents, please contact our support team by email or phone. Our engineering team is committed to providing the required support necessary to ensure that you are successful with the design, integration, and operation of our embedded navigation sensors.

Technical Support Contact Info

Email: support@vectornav.com

Phone: +1.512.772.3615

Table of Contents

1	Introduction	6
1.1	PRODUCT DESCRIPTION	6
1.2	FACTORY CALIBRATION	6
1.3	OPERATION OVERVIEW	6
1.4	GNSS COMPASSING CAPABILITY	7
1.5	MEASUREMENT OUTPUT OPTIONS	7
1.6	PACKAGING OPTIONS	8
1.7	VN-300 PRODUCT CODES	9
2	Specifications	10
2.1	VN-300 SURFACE-MOUNT SENSOR (SMD) ELECTRICAL	10
2.2	VN-300 RUGGED ELECTRICAL	13
2.3	VN-300 SURFACE-MOUNT SENSOR (SMD) DIMENSIONS	15
2.4	VN-300 RUGGED DIMENSIONS	16
2.5	ABSOLUTE MAXIMUM RATINGS	16
2.6	SENSOR COORDINATE SYSTEM	17
3	VN-300 Software Architecture	19
3.1	IMU SUBSYSTEM	19
3.2	NAVSTATE SUBSYSTEM	22
3.3	NAVFILTER SUBSYSTEM	22
3.4	COMMUNICATION INTERFACE	24
3.5	COMMUNICATION PROTOCOL	25
3.6	SPI INTERFACE	26
3.7	SYSTEM ERROR CODES	29
3.8	CHECKSUM / CRC	30
4	Initial Setup and Operation	32
4.1	SETUP GNSS ANTENNAS	32
4.2	SET THE GNSS ANTENNA A OFFSET	34
4.3	ALIGN THE SENSOR TO THE VEHICLE	34
4.4	EXAMPLE GNSS ANTENNA CONFIGURATION	34
4.5	CONFIGURE OUTPUTS	36
5	User Configurable Binary Output Messages	38
5.1	AVAILABLE OUTPUT TYPES	38

5.2	CONFIGURING THE OUTPUT TYPES	38
5.3	SERIAL OUTPUT MESSAGE FORMAT	45
5.4	BINARY GROUP 1 – COMMON OUTPUTS	49
5.5	BINARY GROUP 2 – TIME OUTPUTS	54
5.6	BINARY GROUP 3 – IMU OUTPUTS	57
5.7	BINARY GROUP 4 – GNSS1 OUTPUTS	61
5.8	BINARY GROUP 5 – ATTITUDE OUTPUTS	69
5.9	BINARY GROUP 6 – INS OUTPUTS	72
5.10	BINARY GROUP 7 – GNSS2 OUTPUTS	75
6	System Module	83
6.1	COMMANDS	83
6.2	CONFIGURATION REGISTERS	86
6.3	STATUS REGISTERS	107
6.4	FACTORY DEFAULTS	108
6.5	COMMAND PROMPT	109
7	IMU Subsystem	111
7.1	IMU MEASUREMENT REGISTERS	111
7.2	IMU CONFIGURATION REGISTERS	113
7.3	FACTORY DEFAULTS	120
7.4	COMMAND PROMPT	121
8	GNSS Subsystem	123
8.1	MEASUREMENT REGISTERS	123
8.2	CONFIGURATION REGISTERS	127
8.3	STATUS REGISTERS	132
8.4	NMEA MESSAGES	135
8.5	FACTORY DEFAULTS	144
8.6	COMMAND PROMPT	145
9	Attitude Subsystem	149
9.1	COMMANDS	149
9.2	MEASUREMENT REGISTERS	150
9.3	CONFIGURATION REGISTERS	160
9.4	FACTORY DEFAULTS	160
10	INS Subsystem	161

10.1	COMMANDS	161
10.2	MEASUREMENT REGISTERS	162
10.3	CONFIGURATION REGISTERS	168
10.4	FACTORY DEFAULTS	169
11	Hard/Soft Iron Estimator Subsystem	170
11.1	CONFIGURATION REGISTERS	170
11.2	STATUS REGISTERS	171
11.3	FACTORY DEFAULTS	171
11.4	COMMAND PROMPT	172
12	World Magnetic & Gravity Module	175
12.1	CONFIGURATION REGISTERS	175
12.2	FACTORY DEFAULTS	176
12.3	COMMAND PROMPT	177

1 Introduction

1.1 Product Description

The VN-300 is a miniature, surface-mount, high-performance GNSS-Aided Inertial Navigation System (GNSS/INS). Incorporating the latest solid-state MEMS sensor technology, the VN-300 combines a set of 3-axis accelerometers, 3-axis gyros, 3-axis magnetometer, a barometric pressure sensor, two separate 50-channel L1 GNSS receivers, as well as a 32-bit processor into a miniature aluminum enclosure. The VN-300 couples measurements from the onboard GNSS receivers with measurements from the onboard inertial sensors to provide position, velocity, and attitude estimates of higher accuracies and with better dynamic performance than a standalone GNSS receiver or AHRS. The VN-300 utilizes the two separate onboard GNSS receivers to perform GNSS interferometry utilizing the raw pseudo-range and carrier phase measurements to accurately estimate the heading of the vehicle. This powerful feature enables the VN-300 to accurately estimate heading with respect to true North, without any reliance on magnetic sensors, both in static and dynamic conditions.

1.2 Factory Calibration

MEMS inertial sensors are subject to several common sources of error: bias, scale factor, misalignments, temperature dependencies, and gyro g-sensitivity. All VN-300 sensors undergo a rigorous calibration process at the VectorNav factory to minimize these error sources. Compensation parameters calculated during these calibrations are stored on each individual sensor and digitally applied to the real-time measurements. Unlike the VN-100 and VN-300, the VN-300 is only available with the full thermal calibration option.

- Thermal Calibration – this option extends the calibration process over multiple temperatures to ensure performance specifications are met over the full operating temperature range of -40 C to +85 C.

1.3 Operation Overview

The VN-300 has a built-in microprocessor that runs a robust INS Kalman Filter that estimates the position, velocity, and attitude of the sensor. The VN-300 INS filter couples position and velocity measurements from the onboard GNSS module with inertial sensor measurements from the onboard accelerometers, gyroscopes, magnetometers, as well as the barometric pressure sensor. This coupling provides high accuracy attitude estimates when the sensor is subjected to dynamic motion and also provides position and velocity estimates at high output rates.

When the VN-300 is in motion, the VN-300 INS filter determines the attitude by comparing the position and velocity measurements to the onboard accelerometer measurements, and the magnetometer measurements are ignored by the INS filter. Compared to an AHRS, the heading accuracy is improved since the INS filter does not rely on measurements of Earth's background magnetic field and magnetic disturbances do not have an effect on the attitude solution. In addition, the VN-300 pitch and roll estimates are robust to induced accelerations caused by dynamic motion of the sensor. Under static conditions, the heading angle is no longer observable based on only the correlation between the GNSS position and velocity and the IMU accelerometer. For static and low-dynamic conditions the VN-300 utilizes GNSS compassing techniques to derive accurate heading measurements, without any reliance on the magnetometer.

1.4 GNSS Compassing Capability

The VN-300 differs from all other single GNSS receiver INS systems, in that it has the capability to accurately estimate heading in both static and dynamic conditions by performing compassing on two separate GNSS antennas. The VN-300 can estimate heading by comparing the raw pseudo-range and Doppler measurements between the two GNSS antennas. The VN-300 is capable of measuring accurately (to within millimeters) the location of one antenna with respect to the other in an inertial (non-moving relative to Earth) frame of reference. If the VN-300 also knows the position of the two antennas relative to each other in the sensor's (local body) frame, then it can calculate a heading angle in real-time with a high degree of accuracy. It is important to note that this heading measurement is derived directly from differencing the two GNSS receiver measurements at a single point in time, and as such it is not dependent upon velocity, nor makes any assumptions to its direction. The accuracy is dependent only on the quality of the GNSS signal, the distance between the two antennas, and the user's measurement uncertainty in this distance measurement. With the distance between the two GNSS antennas set to one meter that is accurately measured to better than 1 centimeter, the VN-300 is capable of estimating heading to within an average error of less than 0.5 degrees.

1.5 Measurement Output Options

Outputs from the VN-300 include:

- Position Estimates in the following reference frames:
 - Latitude, Longitude, and Altitude
 - X, Y, Z position in Earth Centered Earth Fixed frame
 - X, Y, Z position in North, East, Down frame
- Velocity Estimates in the following reference frames:
 - X, Y, Z velocities in Earth Centered Earth Fixed frame
 - X, Y, Z velocities in the North, East, Down frame
- Attitude Estimates:
 - Yaw, Pitch, Roll
 - Quaternions
 - Rotation Matrix
- INS Filter Uncertainties
 - Position, Velocity, & Attitude
- GPS Time
 - GPS Time of Week
 - UTC Time
- Angular Rate Measurements:
 - Bias compensated angular rates
 - Calibrated gyro measurements
- Acceleration Measurements:
 - Bias compensated acceleration
 - Calibrated acceleration measurements
 - Gravity vector
- Magnetic Measurements
- Pressure Measurements / Altitude

1.6 Packaging Options

The VN-300 is available in two different configurations; a 30-pin surface mount package (VN-300 SMD) and an aluminum encased module (VN-300 Rugged). The VN-300 surface mount package is well suited for customers looking to integrate the VN-300 sensor at the electronics level while the VN-300 Rugged provides a precision enclosure with mounting tabs and alignment holes for a more off-the-shelf solution.

1.6.1 Surface-Mount Package

For embedded applications, the VN-300 is available in a miniature surface-mount package.

Features

- Small Size: 22 x 24 x 3 mm
- Single Power Supply: 3.2 to 5.5 V
- Communication Interface: Serial TTL & SPI
- Low Power Requirement: < 250 mA @ 5V



1.6.2 Rugged Package

The VN-300 Rugged consists of the VN-300 sensor installed and calibrated in a robust precision aluminum enclosure.

Features

- Precision aluminum enclosure
- Locking 10-pin connector
- Mounting tabs with alignment holes
- Compact Size: 45 x 44 x 11 mm
- Single Power Supply: 3.3 to 14 V
- Communication Interface: Serial RS-232 & TTL



1.6.3 VN-300 Surface Mount Development Kit

The VN-300 Development Kit provides the VN-300 surface-mount sensor installed onto a small PCB, providing easy access to all of the features and pins on the VN-300. Communication with the VN-300 is provided by USB and RS-232 serial communication ports. A 30-pin header provides easy access to each of the critical pins. The VN-300 Development Kit also includes all of the necessary cabling, documentation, and support software.



Features

- Pre-installed VN-300 Sensor
- Onboard USB->Serial converter
- Onboard TTL->RS-232 converter
- 30-pin 0.1" header for access to VN-300 pins
- Power supply jack – 5V (Can be powered from USB)
- Board Size: 76 x 76 x 14 mm

1.6.4 VN-300 Rugged GNSS/INS Development Kit

The VN-300 Rugged development kit includes the VN-300 Rugged sensor along with all of the necessary cabling required for operation. Two cables are provided in each development kit: one for RS-232 communication and a second custom cable with a built in USB converter. The development kit also includes all of the relevant documentation and support software.



Features

- VN-300 Rugged Sensor
- 10 ft RS-232 cable
- 6 ft USB connector cable
- 2x - 16 ft Magnetic Mount GNSS Antennas
- 2x - MCX to SMA Antenna Adapters
- Cable Connection Tool
- CD w/Software Development Kit
- User Manual, Quick Start Guide & Documentation
- Carrying Case

1.7 VN-300 Product Codes

VN-300 Options			
Item Code	Sensor Packaging	Calibration Option	Product Type
VN-300-SMD	Surface Mount Device	Thermal -40C to +85C	GNSS/INS
VN-300-SMD-DEV	Surface Mount Development Kit	Thermal -40C to +85C	GNSS/INS
VN-300	Rugged Module	Thermal -40C to +85C	GNSS/INS
VN-300-DEV	Rugged Development Kit	Thermal -40C to +85C	GNSS/INS
VN-C300-0310	VN-300 Rugged USB Adapter Cable	N/A	Cable
VN-C300-0410	VN-300 Rugged Serial Adapter Cable	N/A	Cable
VN-C300-0510	VN-300 Rugged MMCX GNSS Antenna	N/A	Cable

2 Specifications

2.1 VN-300 Surface-Mount Sensor (SMD) Electrical

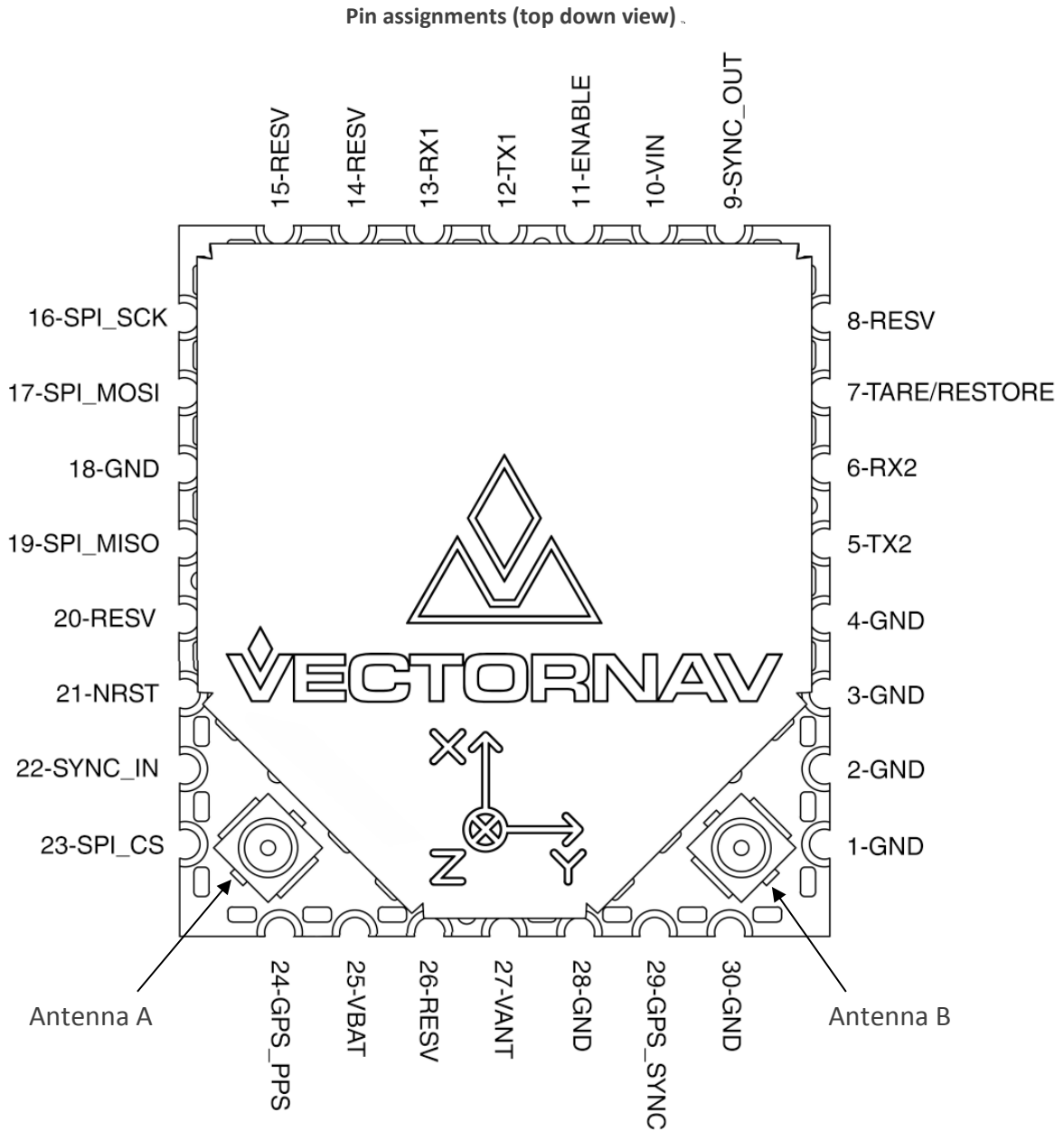

VN-300 SMD Pin Assignments

Pin	Pin Name	Type	Description
1	GND	Supply	Ground.
2	GND	Supply	Ground.
3	GND	Supply	Ground.
4	GND	Supply	Ground.
5	TX2	Output	Serial UART #2 data output. (sensor)
6	RX2	Input	Serial UART #2 data input. (sensor)
7	RESTORE	Input	During power on or device reset, holding this pin high will cause the module to restore the default factory settings. Internally held low with 10k resistor.
8	RESV	N/A	Reserved for internal use. Do not connect.
9	SYNC_OUT	Output	Time synchronization output signal.
10	VIN	Supply	3.2 - 5.5 V input.
11	ENABLE	Input	Leave high for normal operation. Pull low to enter sleep mode. Internally pulled high with pull-up resistor.
12	TX1	Output	Serial UART #1 data output. (sensor)
13	RX1	Input	Serial UART #1 data input. (sensor)
14	RESV	N/A	Reserved for internal use. Do not connect.
15	RESV	N/A	Reserved for internal use. Do not connect.
16	SPI_SCK	Input	SPI clock. *See note below.
17	SPI_MOSI	Input	SPI input. *See note below.
18	GND	Supply	Ground.
19	SPI_MISO	Output	SPI output. *See note below.
20	RESV	N/A	Reserved for internal use. Do not connect.
21	NRST	Input	Microcontroller reset line. Pull low for > 20 μ s to reset MCU. Internally pulled high with 10k.
22	SYNC_IN	Input	Time synchronization input signal.
23	SPI_CS	Input	SPI slave select. *See note below.
24	GPS_PPS	Output	GPS time pulse. One pulse per second, synchronized on rising edge. Pulse width is 100 ms.
25	VBAT	Supply	Optional GNSS RTC battery backup. 1.4 V – 3.6 V input.
26	RESV	N/A	Reserved for internal use. Do not connect.
27	VANT	Supply	External Input voltage supply for antenna. 3 - 5V, 100mA input
28	GND	Supply	Ground.
29	GNSS_SYNC	Output	GNSS sync output pulse. Only available on the VN-300 SMD. See the GNSS Sync Configuration Register for more details.
30	GND	Supply	Ground.

* SPI peripheral on pins 16, 17, 19, & 23 is not currently supported in the current beta firmware. It will be supported on firmware version 1.0 and higher.

2.1.1 VN-300 SMD Power Supply

The minimum operating supply voltage is 3.2V and the absolute maximum is 5.5V.

2.1.2 VN-300 SMD Serial (UART) Interface

The serial interface on the VN-300 operates with 3V TTL logic.

Serial I/O Specifications

Specification	Min	Typical	Max
Input low level voltage	-0.5 V		0.8 V
Input high level voltage	2 V		5.5 V
Output low voltage	0 V		0.4 V
Output high voltage	2.4 V		3.0 V

2.1.3 VN-300 SMD Serial Peripheral Interface (SPI)

Serial I/O Specifications

Specification	Min	Typical	Max
Input low level voltage	-0.5 V		0.8 V
Input high level voltage	2 V		5.5 V
Output low voltage	0 V		0.4 V
Output high voltage	2.4 V		3.0 V
Clock Frequency		8 MHz	16 MHz
Close Rise/Fall Time			8 ns

2.1.4 VN-300 SMD Reset, SyncIn/Out, and Other General I/O Pins

NRST Specifications

Specification	Min	Typical	Max
Input low level voltage	-0.5 V		0.8 V
Input high level voltage	2 V		5.5 V
Weak pull-up equivalent resistor	30 k Ω	40 k Ω	50 k Ω
NRST pulse width	20 μ s		

SyncIn Specifications

Specification	Min	Typical	Max
Input low level voltage	-0.5 V		0.8 V
Input high level voltage	2 V		5.5 V
Pulse Width	100 ns		

SyncOut Specifications

Specification	Min	Typical	Max
Output low voltage	0 V		0.4 V
Output high voltage	2.4 V		3.0 V
Output high to low fall time			125 ns
Output low to high rise time			125 ns
Output Frequency	1 Hz		1 kHz

2.2 VN-300 Rugged Electrical

VN-300 Rugged Pin Assignments

Pin	Pin Name	Description
1	VCC	+3.3V to +14V
2	TX1	RS-232 voltage levels data output from the sensor. (Serial UART #1)
3	RX1	RS-232 voltage levels data input to the sensor. (Serial UART #1)
4	SYNC_OUT	Output signal used for synchronization purposes. Software configurable to pulse when ADC, IMU, or attitude measurements are available.
5	GND	Ground
6	RESTORE	If high at reset, the device will restore to factory default state. Internally held low with 10k resistor.
7	SYNC_IN	Input signal for synchronization purposes. Software configurable to either synchronize the measurements or the output with an external device.
8	TX2_TTL	Serial UART #2 data output from the device at TTL voltage level (3V).
9	RX2_TTL	Serial UART #2 data into the device at TTL voltage level (3V).
10	GPS_PPS	GPS pulse per second output. This pin is a TTL voltage level (3V) output directly connected to the PPS (pulse per second) pin on GNSS receiver A.

VN-300 Rugged External Connector

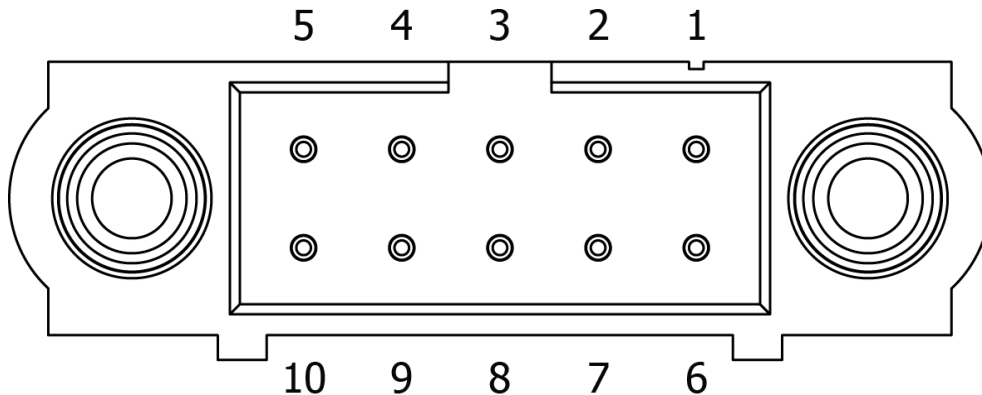

2.2.1 VN-300 Rugged Power Supply

The power supply input for the VN-300 Rugged is 3.3 to 14 V DC.

2.2.2 VN-300 Rugged Serial UART Interface

Serial I/O Specifications

Specification	Min	Typical	Max
Input low level voltage	-25 V		
Input high level voltage			25 V
Output low voltage	-5.0 V	-5.4 V	
Output high voltage	5.0 V	5.5 V	
Output resistance	300 Ω	10 M Ω	
Data rate			1 Mbps
Pulse slew		300 ns	

2.2.3 VN-300 Rugged Reset, SyncIn/Out, and Other General I/O Pins

NRST Specifications

Specification	Min	Typical	Max
Input low level voltage	-0.5 V		0.8 V
Input high level voltage	2 V		5.5 V
Weak pull-up equivalent resistor	30 k Ω	40 k Ω	50 k Ω
NRST pulse width	20 μ s		

SyncIn Specifications

Specification	Min	Typical	Max
Input low level voltage	-0.5V		0.8V
Input high level voltage	2V		5.5V
Pulse Width	100 ns		

SyncOut Specifications

Specification	Min	Typical	Max
Output low voltage	0 V		0.4 V
Output high voltage	2.4 V		3.0 V
Output high to low fall time			125 ns
Output low to high rise time			125 ns
Output Frequency	1 Hz		1 kHz

GPS PPS Specifications

Specification	Min	Typical	Max
Output low voltage	0 V		0.4 V
Output high voltage	2.6 V		3.0 V
Output drive current			4 mA

2.4 VN-300 Rugged Dimensions

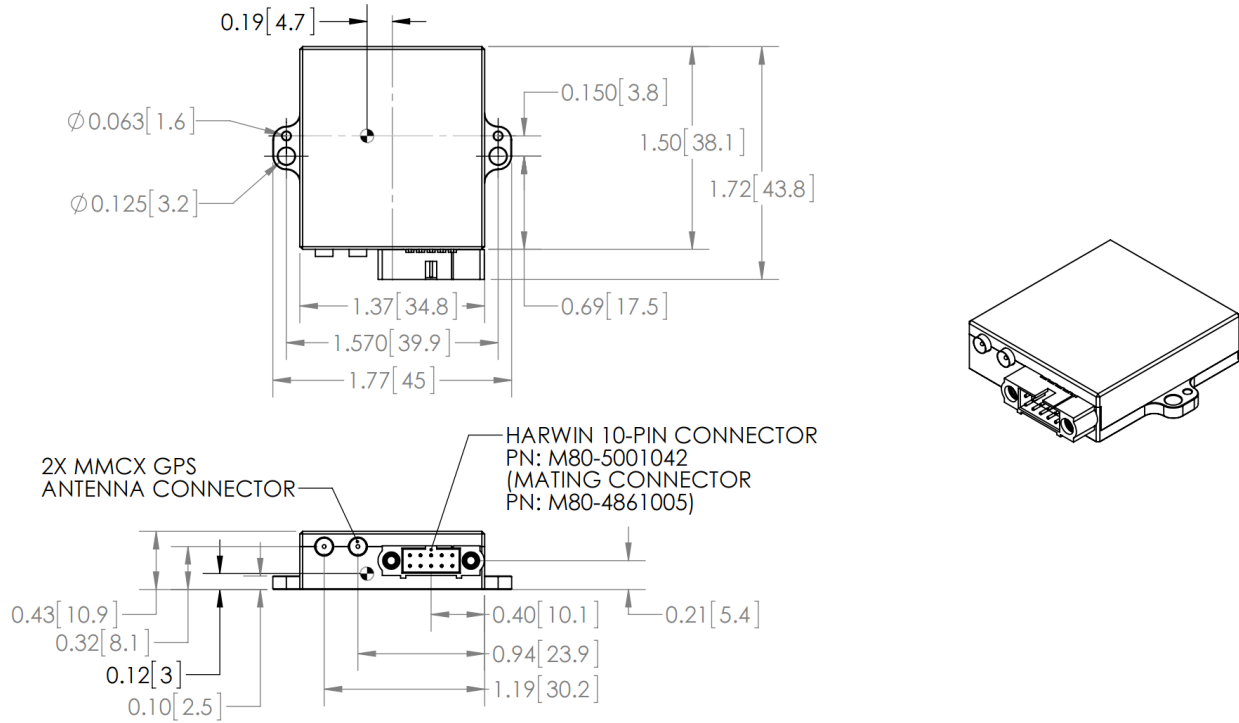

2.4.1 Rugged Connector Type

The main connector used on the VN-300 Rugged is a 10-pin Harwin M80-5001042. The mating connector used on the cable assemblies provided by VectorNav for use with the VN-300 Rugged is a Harwin M80-4861005. The RF connector used on the VN-300 Rugged is a female MMCX jack.

2.5 Absolute Maximum Ratings

SMD Absolute Maximum Ratings

Specification	Min	Max
Input Voltage	-0.3 V	5.5 V
Operating Temperature	-40 C	85 C
Storage Temperature	-40 C	85 C

Rugged Absolute Maximum Ratings

Specification	Min	Max
Input Voltage	-0.3 V	14 V
Operating Temperature	-40 C	85 C
Storage Temperature	-40 C	85 C

2.6 Sensor Coordinate System

2.6.1 Sensor Coordinate Frame

The VN-300 uses a right-handed coordinate system. A positive yaw angle is defined as a positive right-handed rotation around the Z-axis. A positive pitch angle is defined as a positive right-handed rotation around the Y-axis. A positive roll angle is defined as a positive right-handed rotation around the X-axis. The axes direction with respect to the VN-300 module is shown in the figure below.

VN-300 Coordinate System

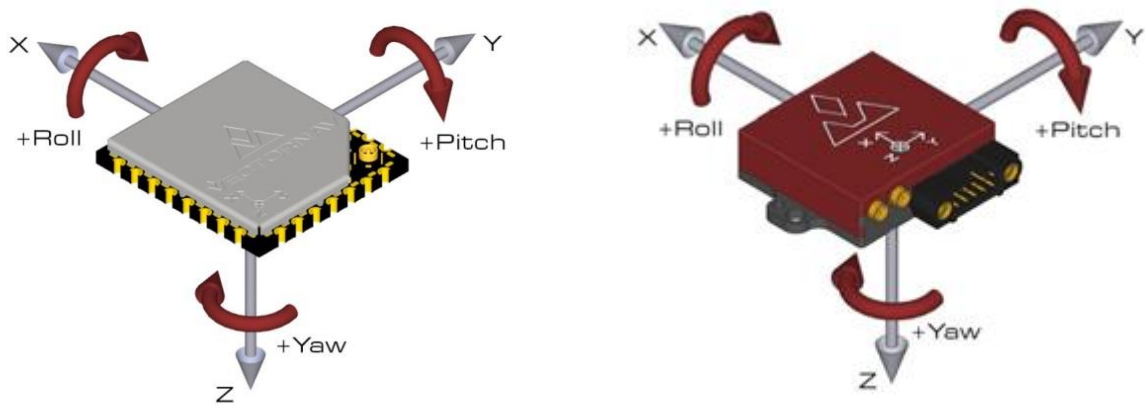

2.6.2 Earth Centered Earth Fixed Frame

The VN-300 position and velocity estimates can be output in the Earth-Centered-Earth-Fixed (ECEF) Frame defined as follows (E_x , E_y , E_z):

- Right-handed, Cartesian, non-inertial frame with origin located at the center of Earth;
- Fixed to and rotates with Earth;
- Positive X-axis aligns with the WGS84 X-axis, which aligns with the International Earth Rotation and Reference Systems Service (IERS) Reference Meridian (IRM);
- Positive Z-axis aligns with the WGS84 Z-axis, which aligns with the IERS Reference Pole (IRP) that points towards the North Pole;
- Positive Y-axis aligns with the WGS84 Y-axis, completing the right-handed system.

Figure 2 - ECEF Frame

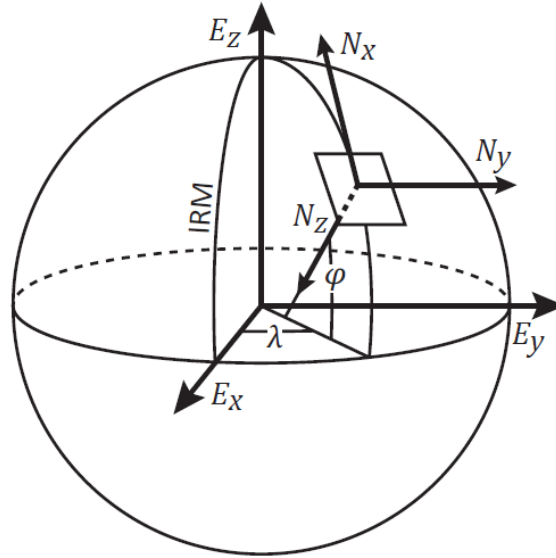

2.6.3 Latitude, Longitude, Altitude

The VN-300 position estimates can be output in Latitude, Longitude, Altitude coordinates defined as follows (φ , λ , h):

- Non-inertial, geodetic frame with origin located at the surface of Earth (WGS84 ellipsoid);
- Latitude is defined as the angle from the equatorial plane to a line normal to the surface of the WGS84 ellipsoid at the location of the VN-300;
- Longitude is defined as the east-west angular displacement measured positive to the east from the IERS Reference Meridian to the location of the VN-300;

Altitude is defined as the distance from the WGS84 ellipsoid to the location of the VN-300 in a direction normal to the ellipsoid.

2.6.4 North-East-Down Frame

The VN-300 velocity estimates can be output in the North-East-Down (NED) coordinate frame defined as follows (\mathbf{N}_x , \mathbf{N}_y , \mathbf{N}_z):

- Right-handed, Cartesian, non-inertial, geodetic frame with origin located at the surface of Earth (WGS84 ellipsoid);
- Positive X-axis points towards North, tangent to WGS84 ellipsoid;
- Positive Y-axis points towards East, tangent to WGS84 ellipsoid;
- Positive Z-axis points down into the ground completing the right-handed system.

3 VN-300 Software Architecture

The software architecture internal to the VN-300 includes five separate subsystems. These subsystems are the IMU, the NavState, the NavFilter, the GNSS, and the Communication Interface. The high-level functions performed by these subsystems are outlined below. This chapter describes these functions performed by these subsystems in more detail and describes which of the various measurement outputs originate from each of these corresponding subsystems.

VN-300 Software Architecture

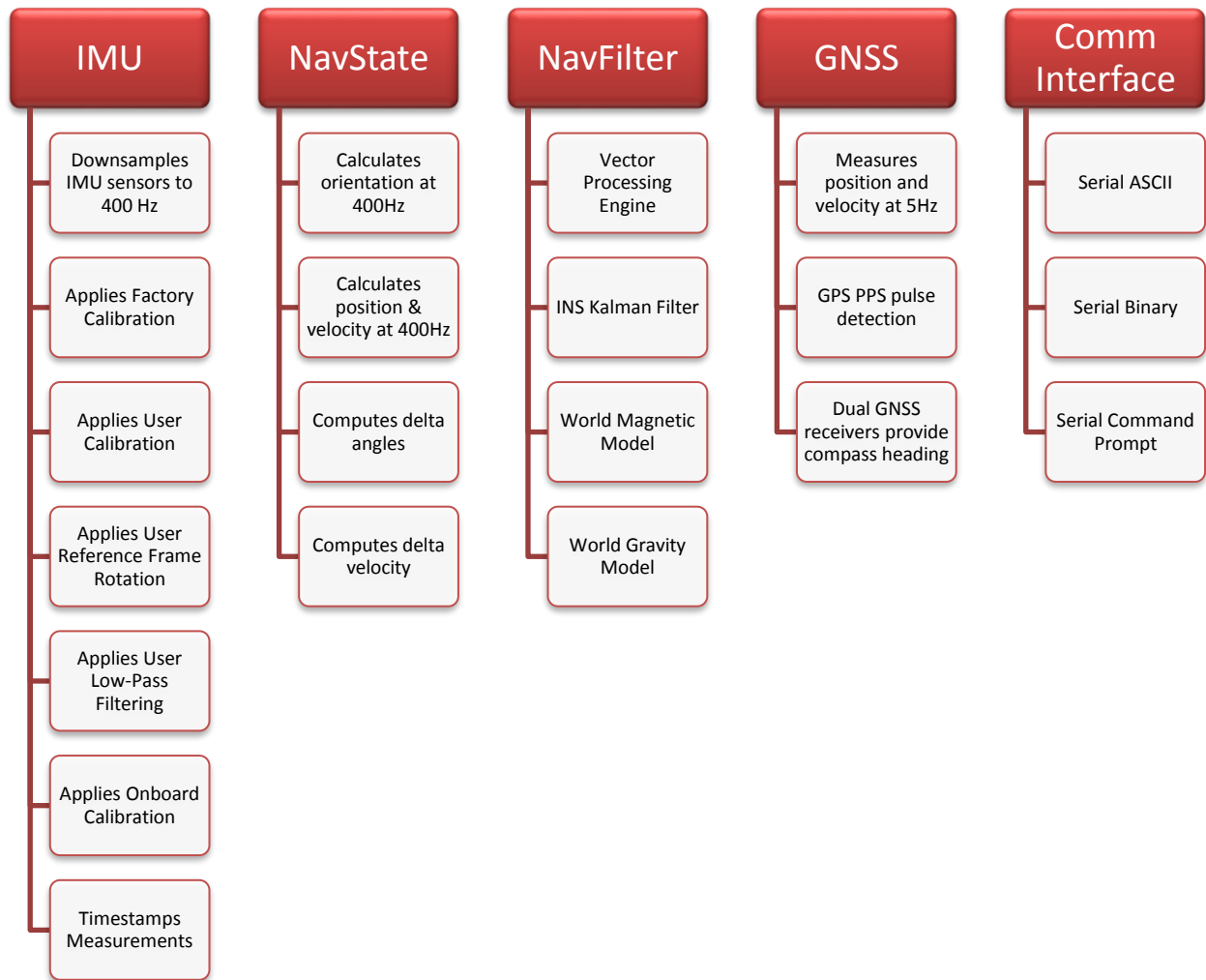

3.1 IMU Subsystem

The IMU subsystem runs at the highest system rate, described from this point forward as the IMU Rate (defaults to 400 Hz). It is responsible for collecting the raw IMU measurements, applying a factory, user, and dynamic calibration to these measurements, and optionally filtering the individual sensor measurements for output. The coning and sculling integrals also are calculated by the IMU subsystem at

the full IMU Rate. The IMU subsystem is also responsible for time stamping the IMU measurements to internal system time, and relative to both the SyncIn and the GPS PPS signal.

3.1.1 Magnetometer

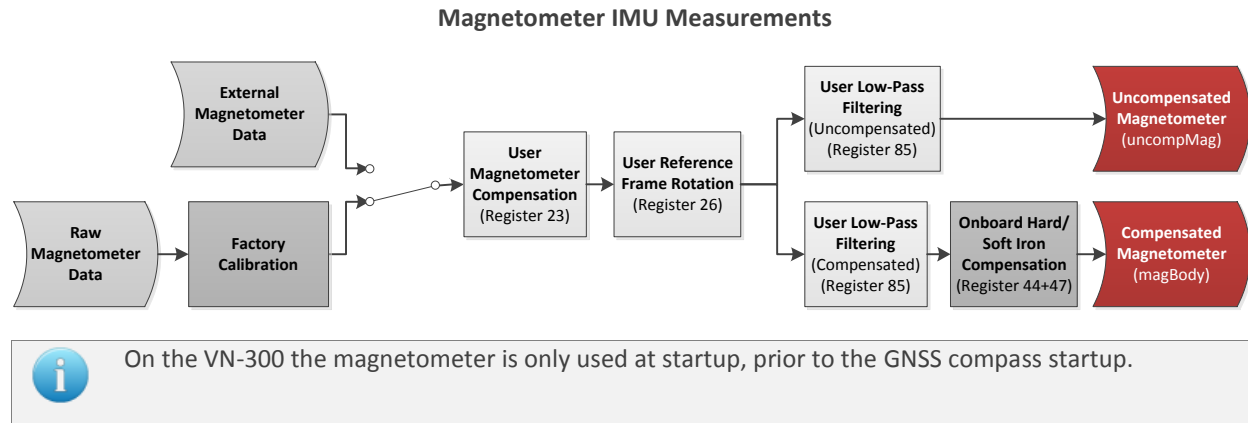

3.1.2 Accelerometer

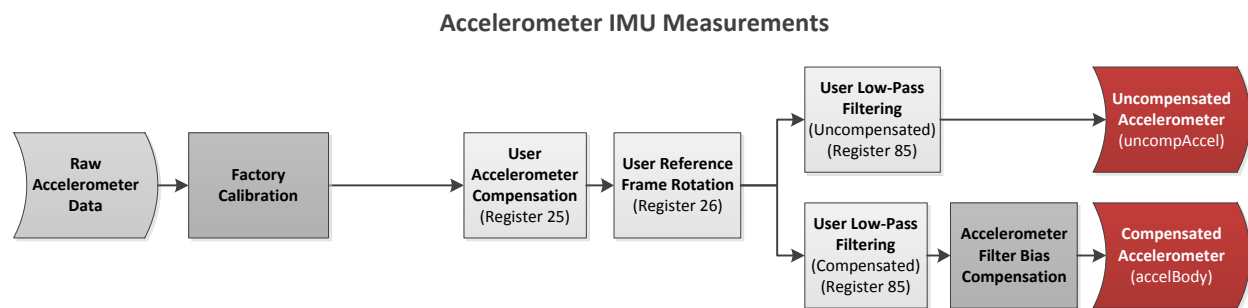

3.1.3 Gyro

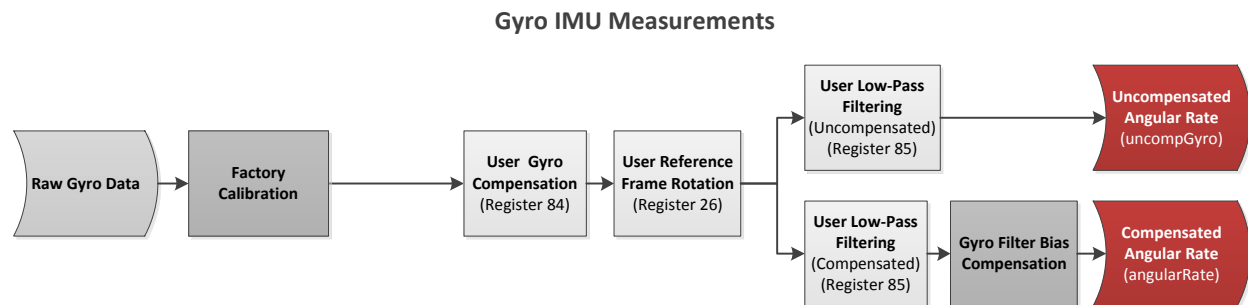

3.1.4 Raw IMU Measurements

The raw IMU measurements are collected from the internal MEMS at the highest rate available for each individual sensor. For the gyro and accelerometer, the measurements are down-sampled to the IMU Rate.

3.1.5 Factory Calibration

Each VN-300 sensor is tested at the factory at multiple known angular rates, accelerations, and magnetic field strengths to determine each sensor's unique bias, scale factor, axis alignment, and temperature

dependence. The calibration coefficients required to remove these unwanted errors are permanently stored in flash memory on each sensor. At the IMU Rate, these calibration coefficients are applied to the raw IMU measurements, to correct for and remove these known measurement errors. For thermally calibrated units the onboard temperature sensor is used to remove the measurement temperature dependence. The output of the factory calibration stage is referred to as the calibrated (but uncompensated) IMU measurements.

3.1.6 User Calibration

The VN-300 provides the user with the ability to apply a separate user calibration to remove additional bias, scale factor, and axis misalignments. The user calibration is applied after the factory calibration, and can be used to optionally fine tune the calibration for each of the individual sensors. The user calibration is optional and in most cases not required for normal operation.

3.1.7 User Reference Frame Rotation

The user reference frame rotation provides the user with the ability to apply a rigid body rotation to each of the sensor outputs. This can be used to transform the coordinate system of the onboard sensors into any other coordinate frame of the user's choice. Since this transformation is applied to the IMU measurements prior to their use in the onboard attitude estimation algorithms, applying a user reference frame rotation will not only change the output coordinates for the IMU measurements, it will also change the IMU body frame for all subsequent attitude estimation calculations.



A write settings and reset command must be issued after setting the Reference Frame Rotation Register before coordinate transformation will be applied.

3.1.8 User Low-Pass Filtering

The VN-300 also provides a means (see Register 85) to apply low-pass filtering to the output compensated IMU measurements. It is important to note that the user low-pass filtering only applies to the output compensated IMU measurements. All onboard Kalman filters in the NavFilter subsystem always use the unfiltered IMU measurements after the User Reference Frame Rotation (Register 26) has been applied. As such the onboard Kalman filtering will not be affected by the user low-pass filter settings. The user low-pass filtering can be used to down-sample the output IMU measurements to ensure that information is not lost when the IMU measurements are sampled by the user at a lower rate than the internal IMU Rate.

3.1.9 Timestamp Measurements

All onboard measurements captured by the IMU subsystem are time stamped relative to several internal timing events. These events include the monotonically increasing system time (time since startup), the time since the last SyncIn event, and the time since the last GPS PPS pulse. These timestamps are recorded with microsecond resolution and ~10 microsecond accuracy relative to the onboard temperature compensated crystal oscillator. The onboard oscillator has a timing accuracy of ~20ppm over the temperature range of -40C to 80C.

3.1.10 Coning & Sculling

The IMU subsystem is also responsible for computing and accumulating the coning and sculling integrals. These integrals track the delta angle and delta velocity accumulated from one time step to another. The

coning and sculling integrals are reset each time the delta angle and/or delta velocity are outputted (asynchronously) or polled from the delta theta and velocity register (Register 80). Between output and polling events, the coning and sculling integration are performed by the IMU subsystem at the IMU Rate.

3.2 NavState Subsystem

The NavState subsystem generates a continuous reliable stream of low-latency, low-jitter state outputs at a rate fixed to the IMU sample rate. The state outputs include any output such as attitude, position, and velocity, which are not directly measurable by the IMU and hence must be estimated by the onboard Kalman filters. The NavState runs immediately after, and in sync with the IMU subsystem, at a rate divisible into the IMU Rate. This rate is referred to as the NavState Rate (default 400 Hz). The NavState decouples the rate at which the state outputs are made available to the user from the rate at which they are being estimated by the onboard Kalman filters. This is very important for many applications which depend on low-latency, low-jitter attitude, position, and velocity measurements as inputs to their control loops. The NavState guarantees the output of new updated state information at a rate fixed to the IMU Rate with very low latency and output jitter. The NavState also provides the ability for the VN-300 to output estimated states at rates faster than the rate of the onboard Kalman filters, which may be affected by system load and input measurements availability.

3.2.1 NavState Measurements

The measurements shown below are calculated by the NavState subsystem and are made available at the NavState Rate (default 400 Hz).

NavState Outputs
Attitude (Yaw, Pitch, Roll, Quaternion, DCM)
Position (LLA, ECEF)
Velocity (NED, ECEF, Body)
Delta Angle (Available at full IMU rate)
Delta Velocity (Available at full IMU rate)

3.3 NavFilter Subsystem

The NavFilter subsystem consists of the INS Kalman filter, the Vector Processing Engine (VPE), and its collection of other Kalman filters and calculations that run at a lower rate than the NavState. Most high level states such as the estimated attitude, position, and velocity are passed from the NavFilter to the NavState, and as such are made available to the user at the NavState rate. There are a handful of outputs however that will only update at the rate of the NavFilter, some of which are listed below.

NavFilter Outputs
Attitude Uncertainty
Position & Velocity Uncertainty
Gyro & Accel Filter Biases
Mag & Accel Disturbance Estimation
Onboard Magnetic Hard & Soft Iron Estimation
World Magnetic & Gravity Model

3.3.1 INS Kalman Filter

The INS Kalman filter consists of an Extended Kalman filter which nominally runs at the NavFilter rate (default 200 Hz). The INS Kalman filter uses the accelerometer, gyro, GNSS, and (at startup) the magnetometer to simultaneously estimate the full quaternion based attitude solution, the position and velocity, as well as the time varying gyro, accelerometer, and barometric pressure sensor biases. The output of the INS Kalman filter is passed to the NavState, allowing for the attitude, position, and velocity to be made available at the higher fixed rate of the NavState.

3.3.2 Vector Processing Engine

The Vector Processing Engine (VPE) is a collection of sophisticated algorithms which provide real-time monitoring and simultaneous estimation of the attitude as well as the uncertainty of the input measurements used by the attitude estimation algorithm. By estimating its own input measurement uncertainty the VPE is capable of providing significantly improved performance when compared to traditional statically tuned Kalman Filters. The estimated measurement uncertainty is used to in real-time adaptively tune the onboard Kalman filters. This adaptive tuning eliminates the need in most cases for the user to perform any custom filter tuning for different applications.

3.3.3 AHRS Kalman Filter

Since the INS Kalman filter relies upon a continuous stream of GNSS measurements to operate, the VN-300 supports automatic transition from INS to AHRS attitude estimation modes. In situations when GNSS measurements are not available, the VN-300 will automatically begin to use the magnetometer and the accelerometer to estimate attitude. The transition is handled automatically by the VN-300, and performed in a seamless fashion, thus eliminating any potential jump discontinuities from appearing in the attitude or angular rate output when the transition to and from AHRS/INS mode is performed. Optionally the user can also manually select between using the INS or AHRS attitude estimation modes. The type of estimation algorithm used is controlled by the INS Scenario field in the INS Basic Configuration Register.

3.3.4 Hard/Soft Iron Estimator

The NavFilter subsystem also includes a separate EKF which provides real-time estimation of the local magnetic hard and soft iron distortions. Hard and soft iron distortions are local magnetic field distortions created by nearby ferrous material which moves with the sensor (attached to the same vehicle or rigid-body as the sensor). These ferrous materials distort the direction and magnitude of the local measured magnetic field, thus negatively impacting the ability of an AHRS to reliably and accurately estimate heading based on the magnetometer measurements. To remove the unwanted effect of these materials, a hard & soft iron calibration needs to be performed which requires rotating the sensor around in multiple circles while collecting magnetic data for off-line calculation of the magnetic hard & soft iron calibration coefficients. This calibration can be very time consuming, and might not be possible for some applications. The onboard hard/soft iron estimator runs in the background without requiring any user intervention. For many applications this simplifies the process for the end user, and allows for operation in environments where the hard/soft iron may change slowly over time. On the VN-300 the onboard hard/soft iron estimator is turned off by default, and can be configured or enabled by the user the Magnetic Calibration Control Register.

3.3.5 World Magnetic Model

The world magnetic model (WMM) is a large spatial-scale representation of the Earth's magnetic field. The internal model used on the VN-300 is consistent with the current WMM2016 model which consist of a spherical-harmonic expansion of the magnetic potential of the geomagnetic field generated in the Earth's core. By default the world magnetic model on the VN-300 is enabled, and automatically uses the estimated position from the INS to directly set the reference magnetic field strength. Alternatively the world magnetic model can be manually used to calculate the magnetic field strength for a given latitude, longitude, altitude, and date which is then subsequently used as the fixed magnetic field reference strength. Control of the world magnetic model is performed using the Reference Vector Configuration Register.

3.3.6 World Gravity Model

The world gravity model (WGM) is a large spatial-scale representation of the Earth's gravity potential as a function of position on the globe. The internal model used on the VN-300 is consistent with the Earth Gravity Model (EGM96), which consist of a spherical-harmonic expansion of the Earth's geopotential. By default the world gravity model on the VN-300 is enabled, and automatically is set based on the estimated INS position. Control of the world gravity model is performed using the Reference Vector Configuration Register.

3.4 Communication Interface

The VN-300 provides two separate communication interfaces on two separate serial ports.

3.4.1 Serial Interface

The serial interface consists of two physically separate bi-directional UARTs. Each UART supports baud rates from 9600 bps up to a maximum of 921600 bps.

The rugged version includes an onboard TTL to RS-232 level shifter, thus at the 10-pin connector one serial port is offered with RS-232 voltages levels (Serial 1), while the other serial port (Serial 2) remains at 3V TTL logic levels.



It is important to note that the ability to update the firmware using the onboard bootloader is only supported on the serial port 1 interface. It is highly recommended that if serial port 1 is not used for normal operation, a means of accessing it is designed into the product to support future firmware updates.

3.4.2 SPI Interface

The SPI interface consists of a standard 4-wire synchronous serial data link which is capable of high data rates up to 16 Mbps. The VN-300 operates as slave on the bus enabled by the master using the slave select (SPI_CS) line. See the Basic Communication chapter for more information on the operation of the SPI interface.

3.5 Communication Protocol

The VN-300 utilizes a simple command based communication protocol for the serial interface. An ASCII protocol is used for command and register polling, and an optional binary interface is provided for streaming high speed real-time sensor measurements.

3.5.1 Serial ASCII

On the serial interface a full ASCII protocol provides support for all commands, and register polling. The ASCII protocol is very similar to the widely used NMEA 0183 protocol supported by most GNSS receivers, and consists of comma delimited parameters printed in human readable text. Below is an example command request and response on the VN-300 used to poll the attitude (Yaw Pitch Roll Register in the Attitude subsystem) using the ASCII protocol.

Example Serial Request

```
$VNRRG,8*4B
```

Example Serial Response

```
$VNRRG,08,-114.314,+000.058,-001.773*5F
```



The VN-300 supports some standard NMEA ASCII messages which can be configured using the NMEA Output Registers 101 & 102.

At the end of this user manual each software subsystem is documented providing a list of all the commands and registers supported by the subsystem on the VN-300. For each command and register an example ASCII response is given to demonstrating the ASCII formatting.

3.5.2 Serial Binary

The serial interface offers support for streaming sensor measurements from the sensor at fixed rates using user configurable binary output packets. These binary output packets provide a low-overhead means of streaming high-speed sensor measurements from the device minimizing both the required bandwidth and the necessary overhead required to parse the incoming measurements for the host system.

3.5.3 Serial Command Prompt

A simple command prompt is also provided on the serial interface, which provides support for advanced device configuration and diagnostics. The serial command prompt is an optional feature that is designed to provide more detailed diagnostic view of overall system performance than is possible using normal command & register structure. It is strictly intended to be used by a human operator, who can type commands to the device using a simple serial terminal, and is not designed to be used programmatically. Each software subsystem described in the software module chapters provides information on the diagnostic commands supported by the serial command prompt at the end of each subsystem section.

3.6 SPI Interface

The VN-300 supports a Serial Peripheral Interface (SPI) communication interface. The SPI interface consists of synchronous serial communication interface where devices communicate in a master/slave mode. The VN-300 operates as a slave while the device communicating with the VN-300 will act as a master. The master provides a clock to the slave which synchronizes the data transfer to the rising and falling edge of the clock signal. Due to its synchronous communication, high data transfer rates, and master/slave operation, the SPI communication interface is ideal for board-level communication over short distances since it doesn't require a complex software protocol stack and is fairly straightforward to program against on embedded devices.

3.6.1 SPI Hardware Requirements

Four hardware lines are required to implement a SPI interface with the VN-300; a clock (SPI_SCK), two data lines (SPI_MOSI and SPI_MISO), and a slave select pin (SPI_CS). The master is responsible for driving both the clock signal and the slave select lines. The slave select line should be pulled low when the master wants to communicate with the slave. If multiple slave devices are used on the same bus, then each slave will have its own dedicated slave select line, while sharing the clock and data lines. The VN-300 will leave the SPI_MISO line in a high impedance state while the SPI_CS line is high, enabling communication with other slave devices on the same SPI bus. When the master is finished communicating with the slave the slave select line is pulled high. The clock line should idle high when not in use. The SPI_MISO and SPI_MOSI pins should both transition between logic states on the falling edge of the SPI_SCK clock signal. Data on both the SPI_MISO and SPI_MOSI should be sampled on the rising edge of the SPI_SCK line. The VN-300 uses 3V digital logic for the SPI interface. If you are interfacing with a 5V system, it is recommended that you use a logic level translation circuit to ensure reliable communication.

SPI Master Settings	
Slave Select	Active Low
Clock Polarity	Idle High (CPOL=1)
Clock Phase	Sample second clock edge (CPHA=1)
Data Format	Most significant bit first (MSB)
Byte Order	Least significant byte first (little-endian)

3.6.2 Software Requirements

Communication with the VN-300 over SPI is conducted with multiple transactions. A transaction for the purpose of this document is defined as a single operation, such as reading or writing to a register on the VN-300 or issuing a command such as requesting a device reset. A single transaction consists to two separate data packets sent to the VN-300. Each packet consists of a four byte header followed by a data payload. The header for the packet differs depending upon whether it is a request packet or a response packet. For each packet sent to the VN-300 the slave select line (SPI_CS) should be pulled low at the beginning of the packet and pulled high at the end.

Figure 3 - Packet Headers

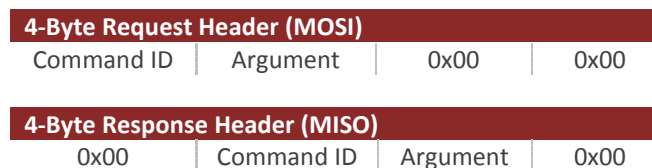

3.6.3 SPI Example Commands

The sections that follow provided some example SPI transactions for the various types of commands available on the VN-300.

SPI Read Register Example

Below is an example of a single transaction with the VN-300 to read register 5.

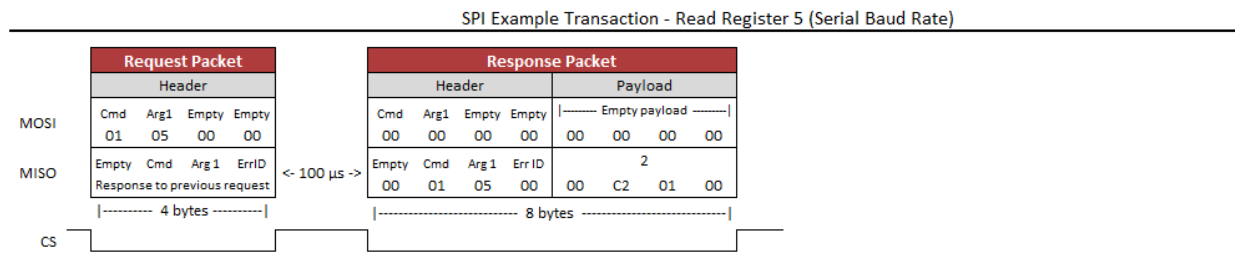

The first packet is the request packet and consists of the master sending out the MOSI line a four byte header with no payload. The first byte in the header has the command ID of 1, which corresponds to a read register request. The second byte is the argument. In the case of the read register command this corresponds to the register ID, which in this case is register 5. The next two bytes are always zero in the header. After this packet is sent the master should raise the slave select line (SPI_CS) and wait at least 100 microseconds before issuing the respond packet. During this time the VN-300 will process the read register request and place the requested data in its SPI output buffer. On the response packet the master should clock in N bytes of zeroes on the MOSI line, where N is equal to 4 plus the size of the register being read, which in this example is register 5 (4 bytes). The header for packets being received from the VN-300 has a different structure with the first byte always being zero. The second and third byte in the header is the command ID and the argument (register ID) of the response. The fourth byte in the header is the error code. If an error occurred while attempting to service the request the VN-300 will issue a non-zero error code in this byte with no payload. In the payload of the response packet the four bytes received correspond to the value of register 5 which in this case is 115200. As you can see from the example multi-byte values are sent in little endian format with the least significant byte sent first (0h01C200 = 115200).

SPI Write Register Example

Below is an example of a write register transaction. In this example the values of {1, 2, 1, 1} are being written to the four fields in the VPE Control Register (Register 35).

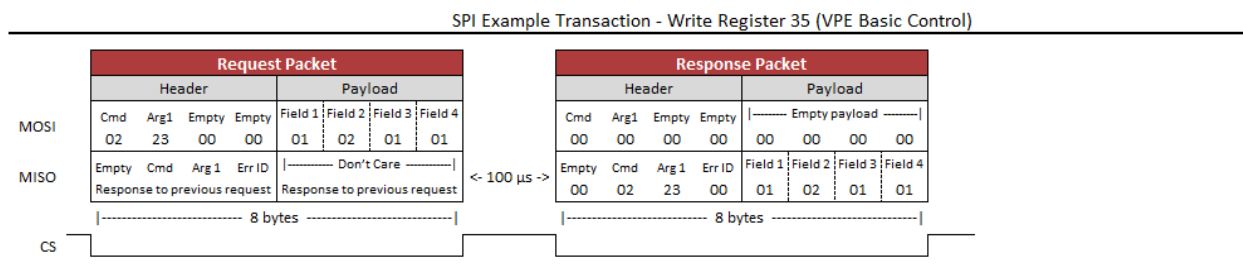

In the case of writing to a register, the values to be loaded into the register are in the payload of the request packet. The payload of the response packet contains the contents of the register after the write register command has been processed. In the case that no error occurred the payload of the response packet should be the same as the request. Because of this it is sufficient to just clock in only four bytes on the response packet to verify that the write register took effect, which is indicated by a zero error code.

SPI Read Register Example – Floating Point Registers

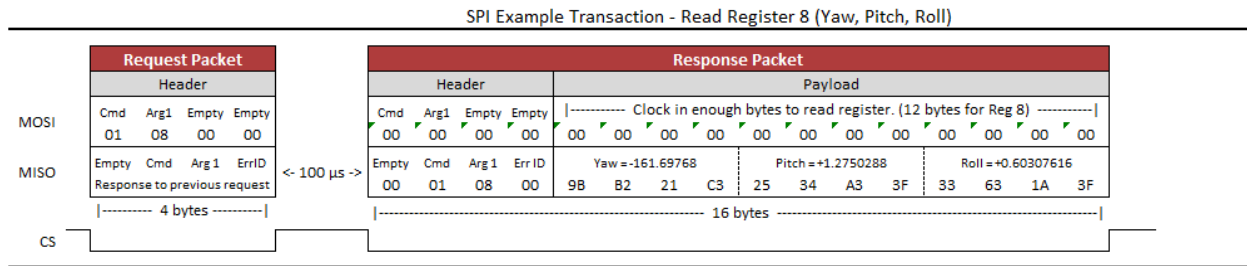

The above examples show a transaction involving reading a register with floating point values. In this case Register 8 is read which contains the sensor attitude (Yaw, Pitch, & Roll). The floating point values are stored as 32-bit IEEE floating point numbers in little endian byte order.

SPI Write Settings Command Example

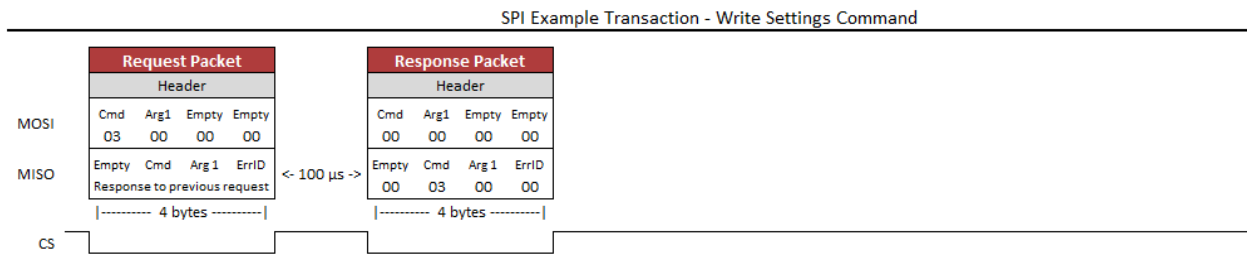

The above example shows an example transaction that consists of issuing a write settings command to the VN-300.

SPI Transaction Error Example

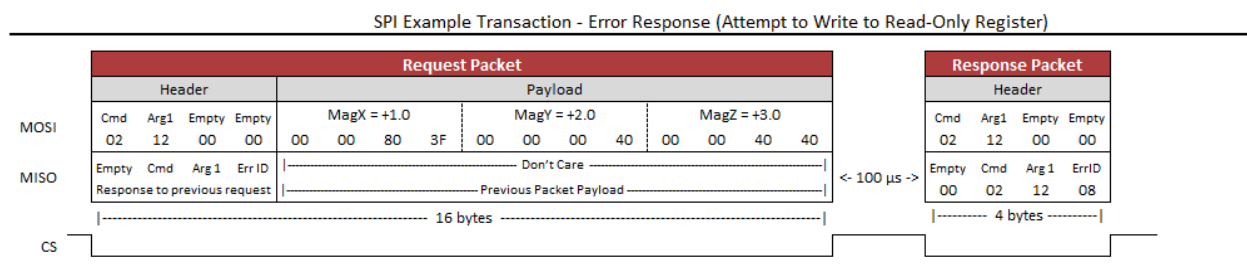

The above example demonstrates what will happen when an error occurs during a transaction. In this case the user attempted to write to a read-only register. The fourth byte of the response packet header shows an Error ID of 8 was returned, which corresponds to an Invalid Register.

3.7 System Error Codes

In the event of an error, the VN-300 will output \$VNERR, followed by an error code. The possible error codes are listed in the table below with a description of the error.

Error Codes

Error Name	Code	Description
Hard Fault	1	If this error occurs, then the firmware on the VN-300 has experienced a hard fault exception. To recover from this error the processor will force a restart, and a discontinuity will occur in the serial output. The processor will restart within 50 ms of a hard fault error.
Serial Buffer Overflow	2	The processor's serial input buffer has experienced an overflow. The processor has a 256 character input buffer.
Invalid Checksum	3	The checksum for the received command was invalid.
Invalid Command	4	The user has requested an invalid command.
Not Enough Parameters	5	The user did not supply the minimum number of required parameters for the requested command.
Too Many Parameters	6	The user supplied too many parameters for the requested command.
Invalid Parameter	7	The user supplied a parameter for the requested command which was invalid.
Invalid Register	8	An invalid register was specified.
Unauthorized Access	9	The user does not have permission to write to this register.
Watchdog Reset	10	A watchdog reset has occurred. In the event of a non-recoverable error the internal watchdog will reset the processor within 50 ms of the error.
Output Buffer Overflow	11	The output buffer has experienced an overflow. The processor has a 2048 character output buffer.
Insufficient Baud Rate	12	The baud rate is not high enough to support the requested asynchronous data output at the requested data rate.
Error Buffer Overflow	255	An overflow event has occurred on the system error buffer.

3.8 Checksum / CRC

The serial interface provides the option for either an 8-bit checksum or a 16-bit CRC. In the event neither the checksum nor the CRC is needed, both can be turned off by the user. Refer to the Communication Protocol Control Register for details on disabling the checksum/CRC.

3.8.1 Checksum Bypass

When communicating with the sensor using a serial terminal, the checksum calculation can be bypassed by replacing the hexadecimal digits in the checksum with uppercase X characters. This works for both the 8-bit and 16-bit checksum. An example command to read register 1 is shown below using the checksum bypass feature.

```
$VNRRG,1*XX
```

3.8.2 8-bit Checksum

The 8-bit checksum is an XOR of all bytes between, but not including, the dollar sign (\$) and asterisk (*). All comma delimiters are included in the checksum calculation. The resultant checksum is an 8-bit number and is represented in the command as two hexadecimal characters. The C function snippet below calculates the correct checksum.

Example C Code

```
// Calculates the 8-bit checksum for the given byte sequence.
unsigned char calculateChecksum(unsigned char data[], unsigned int length)
{
    unsigned int i;
    unsigned char cksum = 0;

    for(i=0; i<length; i++){
        cksum ^= data[i];
    }

    return cksum;
}
```

3.8.3 16-bit CRC

For cases where the 8-bit checksum doesn't provide enough error detection, a full 16-bit CRC is available. The VN-300 uses the CRC16-CCITT algorithm. The resultant CRC is a 16-bit number and is represented in the command as four hexadecimal characters. The C function snippet below calculates the correct CRC.

Example C Code

```
// Calculates the 16-bit CRC for the given ASCII or binary message.
unsigned short calculateCRC(unsigned char data[], unsigned int length)
{
    unsigned int i;
    unsigned short crc = 0;

    for(i=0; i<length; i++){
        crc = (unsigned char)(crc >> 8) | (crc << 8);
        crc ^= data[i];
        crc ^= (unsigned char)(crc & 0xff) >> 4;
        crc ^= crc << 12;
        crc ^= (crc & 0x00ff) << 5;
    }

    return crc;
}
```

4 Initial Setup and Operation

The VN-300 INS has been designed to require minimal configuration by the end user for normal operation. This section provides a high-level overview of the recommended steps that the end user should follow to ensure proper operation of the VN-300 for the application. If you are using the product for the first time, it is recommended that you follow the VN-300 Quick Start Guide that is provided with the VN-300 Development Kit, as it will provide a more detailed step-by-step guide demonstrating how to properly configure the sensor for first time use.

4.1 Setup GNSS Antennas

The first step prior to using the product is to determine how the two GNSS antennas will be mounted on your vehicle or other platform. The accuracy of the heading measurement is inversely proportional to the distance between the two antennas. With nominal conditions (good GNSS availability) the VN-300 can accurately achieve a heading accuracy of less than 0.5 degrees with a distance between the GNSS antennas (baseline length) of 1 meter. The VN-300 can operate with baseline lengths as low as a few centimeters; however the static heading accuracy will scale with the antenna separation distance by approximately $(0.3 \text{ degrees RMS}) / (\text{baseline length in meters})$. For example, a 0.5 meter baseline will provide a static heading accuracy of 0.6 degrees RMS and a 0.25 meter baseline will provide 1.2 degrees RMS. The decrease in accuracy typically levels off around 1.5 to 2.0 degrees RMS for baseline lengths below 20 centimeters. In its factory default state the VN-300 defaults to a 1 meter baseline, although the user can adjust this baseline to any value using the GNSS Compass Baseline Register in the GNSS subsystem.

4.1.1 GNSS Compass Baseline (Factory Default)

As mentioned previously, the VN-300 has a factory default baseline of $\{1, 0, 0\}$ [m]. This vector represents the position of a point on GNSS antenna B relative to the same point on GNSS antenna A in the output coordinate system on the VN-300. The default output coordinate system is engraved on the top of the aluminum enclosure. For the factory default case, GNSS antenna B should be positioned in front of GNSS antenna A relative to the X-axis marked on the VN-300 enclosure as shown in the figure below. If a different baseline length or direction required, then you will need to write the new baseline vector and the measurement uncertainty to the sensor using the GNSS Compass Baseline Register.

GNSS Compass Baseline

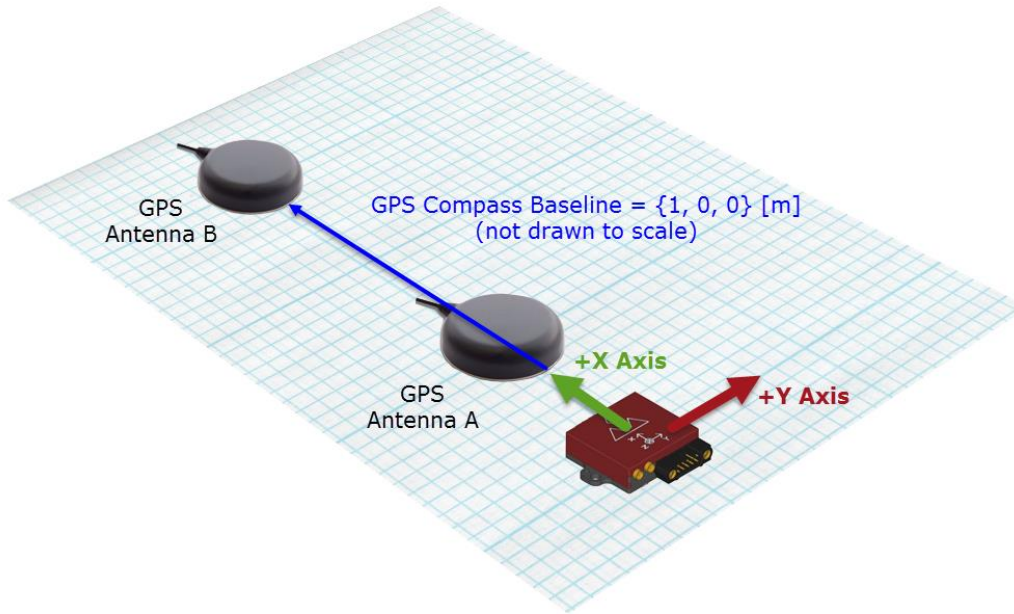

4.1.2 Baseline Measurement Accuracy

It is important the user attempt to measure the distance between the two antennas in each of the three axes as accurately as possible, as the overall heading accuracy of the VN-300 will depend upon the accuracy of this measurement. More specifically the heading accuracy is linearly proportional to the measurement accuracy of the position of GNSS antenna B with respect to GNSS antenna A, and inversely proportional to the baseline length.

$$\text{Heading Error [deg]} \approx 0.57 * (\text{Baseline Error [cm]}) / (\text{Baseline Length [m]})$$

On a 1 meter baseline, a 1 cm measurement error equates to heading error of 0.6 degrees.



It is recommended that you do **not** attempt to measure between the centers of the two antennas. Instead you should measure to more distinguishable point such as the edge of the antenna where the rubber boot mates to the plastic shroud, as this will result in a more repeatable and accurate measurement.



It is very important that the two antennas are oriented in the same direction relative to each other. The RF phase center of the GNSS antenna isn't always located at the geometric center, thus aligning the antennas in the same direction will ensure that our measurement between two geometric points on the antennas is equivalent to the distance between the two antennas RF phase centers.

4.2 Set the GNSS Antenna A Offset

During periods of motion the INS needs to properly account for the relative motion of the primary GNSS antenna (antenna A) with respect to the IMU. In the factory default state the VN-300 assumes that the GNSS antenna A is co-located at the same position (to within 10 centimeters) as the VN-300. If the distance between the VN-300 and the primary GNSS antenna (antenna A) is more than 10 centimeters, then you should measure this offset vector and set it using the GNSS Antenna A Offset Register.



Design Rule of Thumb

Error in the measured GNSS antenna A offset vector has a weaker impact on the overall heading accuracy than that of the GNSS baseline vector. The table below shows how the overall heading accuracy is affected by different amounts of error in the measured GNSS antenna A offset vector.

GNSS Antenna A Offset Measurement Error [cm]	Best Obtainable Heading Accuracy[deg]
< 10	~ 0.3 deg
10 - 50	~ 0.5 deg
50 - 100	~ 1.0 deg

When the distance between the VN-300 IMU and the GNSS antenna A is less than 10 centimeters, it is safe to use the factory default value for this offset of {0, 0, 0}. For offsets above 10 centimeters it is recommended that you measure this offset and set it using the GNSS Antenna A Offset register.

4.3 Align the Sensor to the Vehicle

By default the VN-300 will output the heading, pitch, and roll with respect to the sensor's reference frame which is engraved on the top of the VN-300 aluminum enclosure. To ensure that the output is consistent with the attitude of the vehicle the sensor is attached to you will need to align the sensor on the vehicle such that the X-axis points out the front of the vehicle (bow), the Y-axis points out the right (starboard), and the Z-axis points down. If it is not possible to orient the sensor in this configuration with respect to the vehicle, then you will need to use the Reference Frame Rotation Register to set the relative orientation of the IMU with respect to the vehicle. This register can also optionally be used by the user to take into account small known misalignment errors of the IMU with respect to the vehicle.

4.4 Example GNSS Antenna Configuration

To help better illustrate how the GNSS Antenna A offset vector and the GNSS Compass Baseline vector are measured and defined, let's look at how they would relate to a typical automobile setup. For this example case we will assume that the two GNSS antennas are mounted on the roof of the vehicle, and the VN-300 IMU is located at a lower point inside the cargo bay of a utility van. In the illustration given below the IMU is shown as a blue square with a "I" marker, and the two GNSS antennas are shown as a red circle with the "A" and "B" marker for GNSS antenna A and GNSS antenna B respectively.

Example GNSS Antenna Configuration

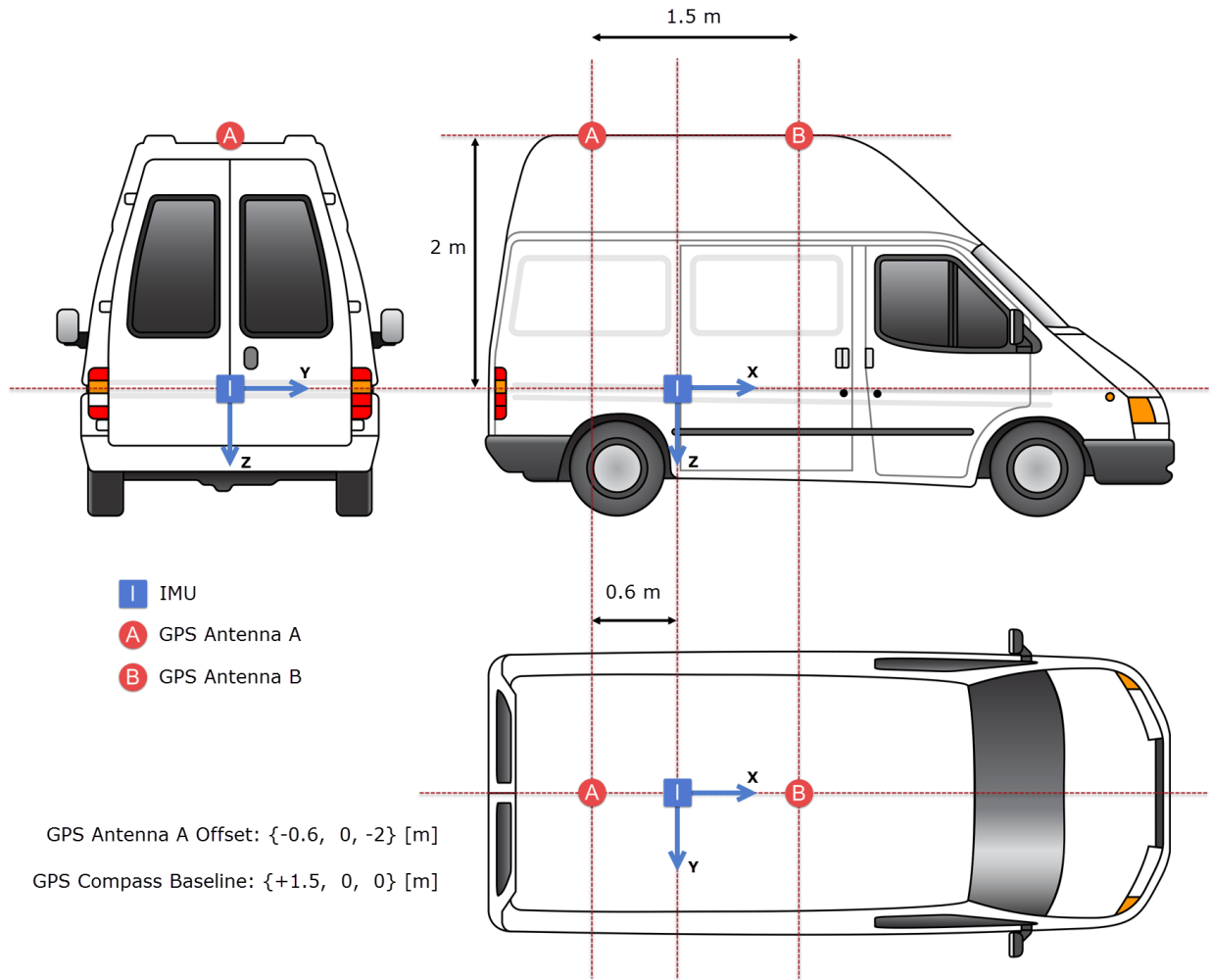

In summary, for this setup the user will need to make two measurements:

Measurement #1:

Measure the position of GNSS antenna A relative to the VN-300 IMU. This measurement is a 3D vector measured in the frame of reference of the IMU output frame. In the case no reference frame rotation is used (factory default), the IMU output frame is the one that is engraved on the VN-300 aluminum enclosure. For automotive applications the X-axis should point out the front of the vehicle, the Y-axis should point out the passenger side, and the Z-axis should point down toward the pavement.

The position of the GNSS antenna A with respect to the VN-300 IMU is known as the GNSS Antenna A offset, and for this setup it is equal to $\{-0.6, 0, -2\}$ [m]. Once this measurement is made, the user will can either set this using Sensor Explorer (VectorNav’s Configuration GUI application), or by simply sending the following ASCII message to the VN-300:

```
$VNWRG,57,-0.6,0,2*XX
```

The above command writes the values **{-0.6, 0, 2}** to register 57 which corresponds to the **GNSS Antenna A Offset** register.

Measurement #2:

The second measurement that needs to be made is the position of GNSS antenna B relative to GNSS antenna A. This measurement also needs to be made relative the IMU output frame, and for this setup it is equal to **{+1.5, 0, 0}** [m]. Once this measurement is made, the user can either set this using Sensor Explorer, or by simply sending the following ASCII message to the VN-300:

```
$VNWRG,93,1.5,0,0,0.038,0.038,0.038*XX
```

The above command writes the values **{+1.5, 0, 0}** to the GNSS Compass Baseline Register in the GNSS subsystem section along with the uncertainties values of **{0.038, 0.038, 0.038}**.



In this example we have scaled the default uncertainty values of {0.0254, 0.0254, 0.0254} by a factor of 1.5 to adjust for the longer baseline length. It is highly recommended that this type of scaling be performed for any baseline longer than the default of 1.0m.

Once these two measurements have been set on the VN-300, you will need to instruct the VN-300 to save these values to flash memory so that they will take effect upon startup. To do this you can issue a “Write Settings” command from Sensor Explorer or by simply sending the following ASCII command to the VN-300:

```
$VNWNV*XX
```

At this point your VN-300 is properly configured and ready for operation.

4.5 Configure Outputs

Under the default configuration settings, the VN-300 will output the INS Solution LLA ASCII message, which includes the GPS Time of Week, GPS Week, INS Status, heading, pitch, roll, latitude, longitude, altitude, velocity in North East Down, and the solution uncertainty as human readable ASCII messages at a rate of 40Hz. The message format for this message is described in detail in the INS Solution LLA register of the INS subsystem section.

The VN-300 provides two different means of obtaining measurements, using either human readable ASCII messages, or user configurable custom binary output messages.

Human Readable ASCII Messages

The VN-300 provides a variety of measurement output combinations which can be selected using the Asynchronous Output Register. The rate of the output can be adjusted from 1 to 200 message per second using the Asynchronous Output Frequency Register. Each different ASCII output message type has its own unique 5 character heading so that it can easily be distinguished in the data stream.

User Configurable Binary Output Messages

Alternatively for higher rate data, or custom message outputs, the VN-300 also supports the ability to construct your own binary output messages. This option provides the user with the ability to select a subset of any of the available measurements that the VN-300 offers, and have it packaged into a single compact binary packet provided at any rate from 1 to 400 times per second. Up to 3 different custom messages can be created, each with its own separate output rate, and configured to output over one or both of the serial ports.

5 User Configurable Binary Output Messages

The VN-300 supports 3 separate user configurable binary output messages available on the serial interface. Each message can be configured by the user to contain any of the available output measurement types from the IMU, NavState, NavFilter, or the GNSS subsystems. The device can be configured to asynchronously output each message at a fixed rate based upon a divisor of the IMU internal sampling rate (IMU Rate).

5.1 Available Output Types

All real-time measurements either measured or estimated by the VN-300 are available using the user output messages. The different output types are organized into multiple output groups. The first group is a combination of the most common outputs from the remaining groups. The other groups are shown below.

Binary Outputs

Time	IMU	GNSS1	Attitude	INS	GNSS2
<ul style="list-style-type: none"> • TimeStartup • TimeGps • GpsTow • GpsWeek • TimeSyncln • TimeGNSSPps • TimeUTC • SyncinCnt • SyncOutCnt • TimeStatus 	<ul style="list-style-type: none"> • Status • UncompMag • UncompAcceI • UncompAngularRate • Temp • Pres • DeltaTheta • DeltaVel • Mag • Accel • AngularRate • SatFlags 	<ul style="list-style-type: none"> • UTC • Tow • Week • NumSats • Fix • PosLla • PosEcef • VelNed • VelEcef • PosU • VelU • TimeU • TimeInfo • DOP • SatInfo • RawMeas 	<ul style="list-style-type: none"> • YawPitchRoll • Quaternion • DCM • MagNed • AccelNed • LinearAccelBody • LinearAccelNed • YprU 	<ul style="list-style-type: none"> • Status • PosLla • PosEcef • VelBody • VelNed • VelEcef • MagEcef • AccelEcef • LinearAccelEcef • PosU • VelU 	<ul style="list-style-type: none"> • UTC • Tow • Week • NumSats • Fix • PosLla • PosEcef • VelNed • VelEcef • PosU • VelU • TimeU • TimeInfo • DOP • SatInfo • RawMeas

5.2 Configuring the Output Types

Configuration of the 3 output messages is performed using the User Output Configuration Registers (Register 75-77). There are 3 separate configuration registers, one for each available output message. The Binary Output Register 1-3 in the System subsystem section describes in more detail the format for these registers. In each of these configuration registers the user can select which output types they want the message to include by specifying the OutputGroup and the OutputFields parameters.

5.2.1 OutputGroup

The OutputGroup and OutputFields parameters consist of variable length arguments to allow conciseness where possible and expandability where necessary.

The OutputGroup parameter consists of one or more bytes which are used to identify the Binary Output Groups from which data will be selected for output (see OutputField parameter). Each 8-bit byte consists of seven group selection bits (Bit 0 through Bit 6) and an extension bit (Bit 7). The extension bit in each byte is used to indicate the presence of a following continuation byte to select additional (higher-numbered) groups. The first byte selects Groups 1-7 (with bit offsets 0-6, respectively), the second byte

(if present) selects Groups 8-14, and so on. The sequence of group selection bytes will always end with a byte whose extension bit is not set.

Name	Bit Offset	Description
Output Group 1	0	Common Group
Output Group 2	1	Time Group
Output Group 3	2	IMU Group
Output Group 4	3	GNSS1 Group
Output Group 5	4	Attitude Group
Output Group 6	5	INS Group
Output Group 7	6	GNSS2 Group



Groups 8-14 are not used, however they are reserved for use in future firmware versions.

5.2.2 OutputFields

The OutputField parameter consists of a series of one or more 16-bit words per selected output group (see OutputGroup parameter) which are used to identify the selected output fields for that group. The first series of one or more words corresponds to the fields for the first selected group, followed by a series of word(s) for the next selected group, and so on. Each 16-bit word consists of 15 group selection bits (Bit 0 through Bit 14) and an extension bit (Bit 15). The extension bit in each word is used to indicate the presence of a following continuation word to select additional (higher-numbered) output fields for the current group. The first word corresponding to a specific group selects fields 1-15 (with bit offsets 0-14, respectively), the second word (if present) selects fields 16-30, and so on. Each sequence of field selection words corresponding to a selected output group ends with a word whose extension bit is not set, and is then followed by a sequence of words for the next selected group (if any).

Below is a list of the available output fields for each output group.

Bit Offset	Group 1 Common	Group 2 Time	Group 3 IMU	Group 4 GNSS1	Group 5 Attitude	Group 6 INS	Group 7 GNSS2
0	TimeStartup	TimeStartup	ImuStatus	UTC	Reserved	InsStatus	UTC
1	TimeGps	TimeGps	UncompMag	Tow	YawPitchRoll	PosLla	Tow
2	TimeSyncln	GpsTow	UncompAccel	Week	Quaternion	PosEcef	Week
3	YawPitchRoll	GpsWeek	UncompGyro	NumSats	DCM	VelBody	NumSats
4	Quaternion	TimeSyncln	Temp	Fix	MagNed	VelNed	Fix
5	AngularRate	TimeGpsPps	Pres	PosLla	AccelNed	VelEcef	PosLla
6	Position	TimeUTC	DeltaTheta	PosEcef	LinearAccelBody	MagEcef	PosEcef
7	Velocity	SynclnCnt	DeltaVel	VelNed	LinearAccelNed	AccelEcef	VelNed
8	Accel	SyncOutCnt	Mag	VelEcef	YprU	LinearAccelEcef	VelEcef
9	Imu	TimeStatus	Accel	PosU		PosU	PosU
10	MagPres		AngularRate	VelU		VelU	VelU
11	DeltaTheta			TimeU			TimeU
12	InsStatus			TimeInfo			TimeInfo
13	SynclnCnt			DOP			DOP
14	TimeGpsPps			SatInfo			SatInfo
15				RawMeas			RawMeas

5.2.3 Setup the Configuration Register

Once you have determined the desired outputs for your output messages, you will need to configure the User Output Message Configuration Registers (Register 75 – 77). These registers are described in detail under the Binary Output Register 1-3 in the System subsystem section, however for reference the format of the register is shown below.

Binary Output Register 1-3				
Register ID :	75-77			Access : Read / Write
Comment :	These registers allow the user to construct a custom output message that contains a collection of desired estimated states and sensor measurements.			
Size (Bytes):	6-22			
Example Response:	\$VNWRG,75,2,4,1,8*XX			
Offset	Name	Format	Unit	Description
0	AsyncMode	uint16	-	Selects whether the output message should be sent out on the serial port(s) at a fixed rate. 0 = None. User message is not automatically sent out either serial port. 1 = Message is sent out serial port 1 at a fixed rate. 2 = Message is sent out serial port 2 at a fixed rate. 3 = Message is sent out both serial ports at a fixed rate.
2	RateDivisor	uint16	-	Sets the fixed rate at which the message is sent out the selected serial port(s). The number given is a divisor of the ImuRate which is nominally 400 Hz. For example to have the sensor output at 50Hz you would set the Divisor equal to 8.
4+N	OutputGroup(N)	uint8	-	Selects which output groups are active in the message. The number of OutputFields in this message should equal the number of active bits in the OutputGroup .
4+N+2*M	OutputField(1)	uint16	-	Selects which output data fields are active within the selected output groups.



In the offset column above the variable N is the number of output group bytes. If data is requested from only groups 1-7, there will be only one output group present (N=1). If data is requested from an output group of 9-14, then two output groups bytes will be present.

The number of OutputFields present must be equal to the number of output groups selected in the OutputGroup byte(s). For example if groups 1 and 3 are selected (OutputGroup = 0x05 or 0b00000101), then there must be two OutputField parameters present (M = 2).



If the number of OutputFields is inconsistent with the number of OutputGroups selected, then the unit will respond with an invalid parameter error when attempting to write to this register.

If the user attempts to turn on more data than it is possible to send out at the current baud rate, the unit will respond with a insufficient baud rate error.



To turn off the binary output it is recommended to set the AsyncMode = 0.

5.2.4 Example Case 1 – Selecting outputs from only the Common Group

For many applications you might be able to get by with only the output types available in the common group. For these situations the configuration of the output message is simple. Suppose only the following information shown below is desired.

Bit Offset	Group 1 Common
0	TimeStartup
3	YawPitchRoll
5	AngularRate

For this example we will assume that the data will be polled using serial port 2 at 50 Hz.

To configure this output message you would send the following command to the VN-300.

```
$VNWRG,75,2,16,01,0029*XX
```

Now let's dissect this command to see what is actually being set:

Field	Value	Description
Header	\$VN	ASCII message header
Command	WRG	Write register command
Register ID	75	Register 75 (Config register for first output message)
AsyncMode	2	Message set to output on serial port 2.
RateDivisor	16	Divisor = 16. If the <i>ImuRate</i> = 800Hz then, the message output rate will be (800 / 16 = 50 Hz).
OutputGroup	01	Groups = 0x01. (Binary group 1 enabled)
GroupField 1	0029	Group 1 Field = 0x0029. In binary 0x0029 = 0b00101001. The active bits correspond to the following active output fields: Bit 0 – TimeStartup Bit 3 – YawPitchRoll Bit 5 - AngularRate
Checksum	XX	Payload terminator and checksum. XX instructs the VN-300 to bypass the checksum evaluation. This allows us to manually type messages in a serial terminal without needing to calculate a valid checksum.
End Line	\r\n	Carriage return and line feed. Terminates the ASCII message.

5.2.5 Example Case 2 – Outputs from multiple Output Groups without extension bits

This example case demonstrates how to select multiple output fields from more than one output group. Assume that the following bold output types are desired:

Bit Offset	Group 1 Common	Group 3 IMU	Group 5 Attitude
0	TimeStartup		
1			
2		UncompAccel	Quaternion
3		UncompAngularRate	
4			MagNed

Also assume that you want the message to stream at 50 Hz over serial port 1.

To configure this output message you would send the following command to the VN-300.

```
$VNWRG,75,1,16,15,0001,000C,0014*XX
```

Now let's dissect this command to see what is actually being set:

Field	Value	Description
Header	\$VN	ASCII message header
Command	WRG	Write register command
Register ID	75	Register 75 (Config register for first output message)
AsyncMode	1	Message sent on serial port 1.
RateDivisor	16	Divisor = 16. If the ImuRate = 800Hz then, the message output rate will be (800 / 16 = 50 Hz).
OutputGroup	15	Groups = 0x15. In binary 0x15 = 0x00010101. The active bits correspond to the following active output groups: Bit 0 – Common Bit 2 – Imu Bit 4 - Attitude
GroupField 1	0001	Group 1 Field = 0x0001. In binary 0x0001 = 0b00000001. The active bits correspond to the following active output fields: Bit 0 – TimeStartup
GroupField 2	000C	Group 2 Field = 0x000C. In binary 0x000C = 0b00001100. The active bits correspond to the following active output fields: Bit 2 – UncompAccel Bit 3 – UncompGyro
GroupField 3	0014	Group 3 Field = 0x0014. In binary 0x0014 = 0b00010100. The active bits correspond to the following active output fields: Bit 2 – Qtn Bit 4 – MagNed
Checksum	XX	Payload terminator and checksum. XX instructs the VN-300 to bypass the checksum evaluation. This allows us to manually type messages in a serial terminal without needing to calculate a valid checksum.
End Line	\r\n	Carriage return and line feed. Terminates the ASCII message.

5.2.6 Example Case 3 – Outputs from multiple Output Groups with extension bits

This example case demonstrates how to select multiple output fields from more than one output group with the use of extension bits. Assume that the following bold output types are desired:

Bit Offset	Group 1 Common	Group 3 IMU	Group 4 GNSS1	Group 5 Attitude
0	TimeStartup			
1			GpsTow	
2		UncompAccel	GpsWeek	Quaternion
3		UncompAngularRate		
4				MagNed
5				
6				
7				
8				
9				
10				
11				
12				
13				
14				
15			RawMeas	

Also assume that you want the message to stream at 5 Hz over serial port 1.

To configure this output message you would send the following command to the VN-300.

```
$VNWRG, 75, 1, 160, 1D, 0001, 000C, 8006, 0001, 0014*XX
```

Now let's dissect this command to see what is actually being set:

Field	Value	Description
Header	\$VN	ASCII message header
Command	WRG	Write register command
Register ID	75	Register 75 (Config register for first output message)
AsyncMode	1	Message sent on serial port 1.
RateDivisor	160	Divisor = 160. If the ImuRate = 800Hz then, the message output rate will be (800 / 160 = 5 Hz).
OutputGroup	1D	Groups = 0x1D. In binary 0x1D = 0x00011101. The active bits correspond to the following active output groups: Bit 0 – Common Bit 2 – Imu Bit 3 – GNSS Bit 4 – Attitude
GroupField 1	0001	Group 1 Field = 0x0001. In binary 0x0001 = 0b00000001. The active bits correspond to the following active output fields: Bit 0 – TimeStartup
GroupField 2	000C	Group 2 Field = 0x000C. In binary 0x000C = 0b00001100. The active bits correspond to the following active output fields:

		Bit 2 – UncompAccel Bit 3 – UncompGyro
GroupField 3	8006,0001	Group 3 Field = 8006,0001. The most significant bit signifies that there subsequent uint16 words involved in this group field. Since the subsequent uint16 word (0001) does not have its extension bit set, the entire group field consist of two uint16 words, and thus can be considered as a uint32 for this example. The remaining fifteen bits in the first word (0006) are the least most significant bits of this uint32 group field. The next word (0001) has its own extension bit which is zero in this case since we do not need to extend out any further. The remaining fifteen bits are the next 15 data bits. The first bit in this group is the 16th overall bit which signals that the RawMeas field has been selected. Bit 1 – GpsTow Bit 2 – GpsWeek Bit 15 – RawMeas
GroupField 4	0014	Group 3 Field = 0x0014. In binary 0x0014 = 0b00010100. The active bits correspond to the following active output fields: Bit 2 – Qtn Bit 4 – MagNed
Checksum	XX	Payload terminator and checksum. XX instructs the VN-300 to bypass the checksum evaluation. This allows us to manually type messages in a serial terminal without needing to calculate a valid checksum.
End Line	\r\n	Carriage return and line feed. Terminates the ASCII message.

5.3 Serial Output Message Format

The binary output message packets on the serial interface consist of a simple message header, payload, and a 16-bit CRC. An example packet is shown below for reference. The header is variable length depending upon the number of groups active in the message.

Field	Header				Payload				CRC			
	Sync	Groups	Group Field 1		Group Field 2		Payload		CRC			
Byte Offset	0	1	2	3	4	5	6	7	...	N	N+1	N+2
Type	u8	u8	u16		u16		Variable				u16	

5.3.1 Sync Byte

The sync byte is the first byte in the header. Its value will always be equal to 0xFA.

5.3.2 Groups

The Group and Group Field parameters consist of variable length arguments to allow conciseness where possible and expandability where necessary.

The Group parameter consists of one or more bytes which are used to identify the Binary Output Groups from which data will be selected for output (see OutputField parameter). Each 8-bit byte consists of seven group selection bits (Bit 0 through Bit 6) and an extension bit (Bit 7). The extension bit in each byte is used to indicate the presence of a following continuation byte to select additional (higher-numbered) groups. The first byte selects Groups 1-7 (with bit offsets 0-6, respectively), the second byte (if present) selects Groups 8-14, and so on. The sequence of group selection bytes will always end with a byte whose extension bit is not set. The various groups are shown below.

Name	Bit Offset	Description
Binary Group 1	0	General Purpose Group.
Binary Group 2	1	Time and Event Count Group.
Binary Group 3	2	Inertial Measurement Unit Group.
Binary Group 4	3	GNSS1 Measurement Group.
Binary Group 5	4	AHRS Group.
Binary Group 6	5	INS Group.
Binary Group 7	6	GNSS2 Measurement Group.
Binary Group 8	7	Not used. Must be set to zero.



Groups 8-14 are not used, however they are reserved for use in future firmware versions.

5.3.3 Group Fields

The Group Field parameter consists of a series of one or more 16-bit words per selected output group which are used to identify the selected output fields for that group. The first series of one or more words corresponds to the fields for the first selected group, followed by a series of word(s) for the next selected group, and so on. Each 16-bit word consists of 15 group selection bits (Bit 0 through Bit 14) and an extension bit (Bit 15). The extension bit in each word is used to indicate the presence of a following continuation word to select additional (higher-numbered) output fields for the current group. The first word corresponding to a specific group selects fields 1-15 (with bit offsets 0-14, respectively), the second

word (if present) selects fields 16-30, and so on. Each sequence of field selection words corresponding to a selected output group ends with a word whose extension bit is not set, and is then followed by a sequence of words for the next selected group (if any).

The group fields represent which output types have been selected in the active binary groups. The number of group fields in the header will depend upon how many groups are active in the message. The number of group fields present in the header will always be equal to the number of active bits in the group byte. When parsing the binary packet you can count the number of active bits present in the group byte, and then you can assume that this number of group fields will be present in the header. For example if only binary group 1 is selected (Group Byte = 0x01), then only one Group field will be present in the header, thus the header will be 4 bytes in length. If both binary group 1 and 3 are active (Group Byte = 0x05), then two Group field elements will be present in the header (4 bytes), thus the header in this case will be 6 bytes in length.

5.3.4 Payload

The payload will consist of the output data selected based upon the bits selected in the group byte and the group field bytes. All output data in the payload section consist of the active outputs selected for binary group 1, followed by the active outputs selected for binary group 2, and so forth. No padding bytes are used between output fields.

5.3.5 CRC

The CRC consists of a 16-bit CRC of the packet. The CRC is calculated over the packet starting just after the sync byte in the header (not including the sync byte) and ending at the end of the payload. More information about the CRC algorithm and example code for how to perform the calculation is shown in the Checksum/CRC section of the Software Architecture chapter. The CRC is selected such that if you compute the 16-bit CRC starting with the group byte and include the CRC itself, a valid packet will result in 0x0000 computed by the running CRC calculation over the entire packet. This provides a simple way of detecting packet corruption by simply checking to see if the CRC calculation of the entire packet (not including the sync byte) results in zero.

5.3.6 Payload Length

When parsing the packet you will need to know the length of the payload (in bytes) in order to know where the packet ends in the data stream. In order to reduce the overhead of the packet header length, the length of the payload is not included in the header. Instead it should be derived based upon determining the type of data present in the packet. All output data types are fixed length, thus the total length of the payload can be determined based upon inspection of the group byte and the group field bytes. In most applications you will likely only use a few binary output types, thus hard coding the payload length in your parser is the easiest approach. If you want to develop a more generic parser that can handle all available data output types supported by the VN-300, the easiest approach is to use a table lookup. Below is a table with the payload size (in bytes) for all available output types.

Binary Output Payload Length In Bytes

	Group 1	Group 2	Group 3	Group 4	Group 5	Group 6	Group 7
Field 1	8	8	2	8	2	2	8
Field 2	8	8	12	8	12	24	8
Field 3	8	8	12	2	16	24	2
Field 4	12	2	12	1	36	12	1
Field 5	16	8	4	1	12	12	1
Field 6	12	8	4	24	12	12	24
Field 7	24	8	16	24	12	12	24
Field 8	12	4	12	12	12	12	12
Field 9	12	4	12	12	12	12	12
Field 10	24	1	12	12		4	12
Field 11	20		12	4		4	4
Field 12	28			4			4
Field 13	2			2			2
Field 14	4			28			28
Field 15	8			2+(N*8)			2+(N*8)
Field 16				12+(N*28)			12+(N*28)



The messages highlighted in red in the above table are variable length messages. The size of these messages will be dependent upon the number of packets present. See the description of the fields in the appropriate group section below for more information on how to determine the length of these packets.

5.3.7 Example Cases

To help you better understand how the binary protocol works, the next two sections provide an overview of how the binary output packets are formed for two separate example cases.

Example Case 1

For example 1 we will assume that only binary group 1 is active, and only the yaw, pitch, and roll output is active within this binary group. In this case the header will have the following form.

Field	Header			Payload												CRC	
	Sync	Group	Group 1 Fields	YawPitchRoll												CRC	
Byte Offset	0	1	2 3	4	5	6	7	8	9	10	11	12	13	14	15	16	17
Byte Value (Hex)	FA	01	08 00	93	50	2E	42	83	3E	F1	3F	48	B5	04	BB	92	88
Type	u8	u8	u16	float				float				float				u16	
Value	0xFA	1	8	0x422E5093 +43.578686 (Yaw)				0x3FF13E83 +1.8847202 (Pitch)				0xBB04B548 -2.0249654e-3 (Roll)				0x9288	

Example Case 2

For the second example case we will assume that both binary group 1 and 3 are active. In binary group 1, the Ypr output is selected, and in binary group 3, the Temp output is selected.

Header						
Field	Sync	Group	Group 1		Group 3	
			Fields		Fields	
Byte Offset	0	1	2	3	4	5
Byte Value (Hex)	FA	05	08	00	10	00
Type	u8	u8	u16		u16	
Value	0xFA	0x05	0x08		0x01	

Payload																CRC		
Field	YawPitchRoll												Temp		CRC			
Byte Offset	6	7	8	9	10	11	12	13	14	15	16	17	18	19	20	21	22	23
Byte Value (Hex)	A4	15	02	42	4D	DF	EB	3F	F6	1A	36	BE	BF	2D	A4	41	AF	1A
Type	float				float				float				float		u16			
Value	0x420215A4 +32.521133 (Yaw)				0X3FEBDF4D +1.8427521 (Pitch)				0XBE361AF6 -1.7783722e-1 (Roll)				0X41A42DBF +20.522337 (Temp)		0XA83A			

5.4 Binary Group 1 – Common Outputs

Binary group 1 contains a wide assortment of commonly used data required for most applications. All of the outputs found in group 1 are also present in the other groups. In this sense, group 1 is a subset of commonly used outputs from the other groups. This simplifies the configuration of binary output messages for applications that only require access to the commonly used data found in group 1. For these applications you can hard code the group field to 1, and not worry about implemented support for the other binary groups. Using group 1 for commonly used outputs also has the advantage of reducing the overall packet size, since the packet length is dependent upon the number of binary groups active.

Binary Group 1

Name	Bit Offset	Description
TimeStartup	0	Time since startup.
TimeGps	1	GPS time.
TimeSyncln	2	Time since last Syncln trigger.
Ypr	3	Estimated attitude as yaw pitch and roll angles.
Qtn	4	Estimated attitude as a quaternion.
AngularRate	5	Compensated angular rate.
Position	6	Estimated position. (LLA)
Velocity	7	Estimated velocity. (NED)
Accel	8	Estimated acceleration (compensated). (Body)
Imu	9	Calibrated uncompensated gyro and accelerometer measurements.
MagPres	10	Calibrated magnetic (compensated), temperature, and pressure measurements.
DeltaTheta	11	Delta time, theta, and velocity.
InsStatus	12	INS status.
SynclnCnt	13	Syncln count.
TimeGpsPps	14	Time since last GPS PPS trigger.
Resv	15	Reserved for future use. Should be set to zero.

5.4.1 Time Startup

The system time since startup measured in nano seconds. The time since startup is based upon the internal TXCO oscillator for the MCU. The accuracy of the internal TXCO is +/- 20ppm (-40C to 85C). This field is equivalent to the TimeStartup field in group 2.

		TimeStartup							
Byte Offset		0	1	2	3	4	5	6	7
Type		uint64							

5.4.2 TimeGPS

The absolute GPS time since start of GPS epoch 1980 expressed in nano seconds. This field is equivalent to the TimeGps field in group 2.

		TimeGps							
Byte Offset		0	1	2	3	4	5	6	7
Type		uint64							

5.4.3 TimeSyncln

The time since the last Syncln trigger event expressed in nano seconds. This field is equivalent to the TimeSyncln field in group 2.

		TimeSyncln							
Byte Offset		0	1	2	3	4	5	6	7
Type		uint64							

5.4.4 YawPitchRoll

The estimated attitude Yaw, Pitch, and Roll angles measured in degrees. The attitude is given as a 3,2,1 Euler angle sequence describing the body frame with respect to the local North East Down (NED) frame. This field is equivalent to the YawPitchRoll field in group 5.

		YawPitchRoll											
		yaw				pitch				roll			
Byte Offset		0	1	2	3	4	5	6	7	8	9	10	11
Type		float				float				float			

Name	Range
Yaw	+/- 180°
Pitch	+/- 90°
Roll	+/-180°

5.4.5 Quaternion

The estimated attitude quaternion. The last term is the scalar value. The attitude is given as the body frame with respect to the local North East Down (NED) frame. This field is equivalent to the Quaternion field in group 5.

		Quaternion															
		qtn[0]				qtn[1]				qtn[2]				qtn[3]			
Byte Offset		0	1	2	3	4	5	6	7	8	9	10	11	12	13	14	15
Type		float				float				float				float			

5.4.6 AngularRate

The estimated angular rate measured in rad/s. The angular rates are compensated by the onboard filter bias estimates. The angular rate is expressed in the body frame. This field is equivalent to the AngularRate field in group 3.

		AngularRate											
		rate[0]				rate[1]				rate[2]			
		Body X-Axis				Body Y-Axis				Body Z-Axis			
Byte Offset		0	1	2	3	4	5	6	7	8	9	10	11
Type		float				float				float			

5.4.7 Position

The estimated position given as latitude, longitude, and altitude given in [deg, deg, m] respectively. This field is equivalent to the PosLla field in group 6.

		Position																							
		latitude							longitude							altitude									
Byte Offset		0	1	2	3	4	5	6	7	8	9	10	11	12	13	14	15	16	17	18	19	20	21	22	23
Type		double							double							double									

5.4.8 Velocity

The estimated velocity in the North East Down (NED) frame, given in m/s. This field is equivalent to the VelNed field in group 6.

		Velocity											
		vel[0]				vel[1]				vel[2]			
		North Axis				East Axis				Down Axis			
Byte Offset		0	1	2	3	4	5	6	7	8	9	10	11
Type		float				float				float			

5.4.9 Accel

The estimated acceleration in the body frame, given in m/s². This acceleration includes gravity and has been bias compensated by the onboard INS Kalman filter. This field is equivalent to the Accel field in group 3.

		Accel											
		accel[0]				accel[1]				accel[2]			
		Body X-Axis				Body Y-Axis				Body Z-Axis			
Byte Offset		0	1	2	3	4	5	6	7	8	9	10	11
Type		float				float				float			

5.4.10 Imu

The uncompensated IMU acceleration and angular rate measurements. The acceleration is given in m/s², and the angular rate is given in rad/s. These measurements correspond to the calibrated angular rate and acceleration measurements straight from the IMU. The measurements have not been corrected for bias offset by the onboard Kalman filter. These are equivalent to the UncompAccel and UncompGyro fields in group 3.

		Imu																							
		accel[0]				accel[1]				accel[2]				rate[0]				rate[1]				rate[2]			
		Body X-Axis				Body Y-Axis				Body Z-Axis				Body X-Axis				Body Y-Axis				Body Z-Axis			
Byte Offset		0	1	2	3	4	5	6	7	8	9	10	11	12	13	14	15	16	17	18	19	20	21	22	23
Type		float				float				float				float				float				float			

5.4.11 MagPres

The compensated magnetic, temperature, and pressure measurements from the IMU. The magnetic measurement is given in Gauss, and has been corrected for hard/soft iron corrections (if enabled). The temperature measurement is given in Celsius. The pressure measurement is given in kPa. This field is equivalent to the Mag, Temp, and Pres fields in group 3.

		MagPres																				
		mag[0]				mag[1]				mag[2]				temp			pres					
		Body X-Axis				Body Y-Axis				Body Z-Axis				IMU Temp								
Byte Offset	Type	0	1	2	3	4	5	6	7	8	9	10	11	12	13	14	15	16	17	18	19	
		float				float				float				float						float		

5.4.12 DeltaThetaVel

The delta time, angle, and velocity measurements. The delta time (dtime) is the time interval that the delta angle and velocities are integrated over. The delta theta (dtheta) is the delta rotation angles incurred due to rotation, by the local body reference frame, since the last time the values were outputted by the device. The delta velocity (dvel) is the delta velocity incurred due to motion, by the local body reference frame, since the last time the values were outputted by the device. The frame of reference of these delta measurements are determined by the IntegrationFrame field in the Delta Theta and Delta Velocity Configuration Register (Register 82). These delta angles and delta velocities are calculated based upon the onboard coning and sculling integration performed onboard the sensor at the full IMU rate (default 800Hz). The integration for both the delta angles and velocities are reset each time either of the values are either polled or sent out due to a scheduled asynchronous ASCII or binary output. Delta Theta and Delta Velocity values correctly capture the nonlinearities involved in measuring motion from a rotating strapdown platform (as opposed to the older mechanically inertial navigation systems), thus providing you with the ability to integrate velocity and angular rate at much lower speeds (say for example 10 Hz, reducing bandwidth and computational complexity), while still maintaining the same numeric precision as if you had performed the integration at the full IMU measurement rate of 800Hz. This field is equivalent to the DeltaTheta and DeltaVel fields in group 3 with the inclusion of the additional delta time parameter.

		DeltaThetaVel															
		dtime			dtheta[0]				dtheta[1]				dtheta[2]				
		sec			X-Axis				Y-Axis				Z-Axis				
		deg			deg				deg				deg				
Byte Offset	Type	0	1	2	3	4	5	6	7	8	9	10	11	12	13	14	15
		float			float				float				float				

		DeltaThetaVel (continued)														
		dvel[0]					dvel[1]					dvel[2]				
		X-Axis					Y-Axis					Z-Axis				
		m/s					m/s					m/s				
Byte Offset	Type	16	17	18	19	20	21	22	23	24	25	26	27			
		float					float					float				

5.4.13 InsStatus

The INS status bitfield. This field is equivalent to the InsStatus field in group 6. See INS Solution LLA Register for more information on the individual bits in this field.

SolStatus	
Byte Offset	0 1
Type	u16

5.4.14 SyncInCnt

The number of SyncIn trigger events that have occurred. This field is equivalent to the SyncInCnt field in group 2.

SyncInCnt			
Byte Offset	0	1	2 3
Type	u32		

5.4.15 TimeGpsPps

The time since the last GPS PPS trigger event expressed in nano seconds. This field is equivalent to the TimePPS field in group 2.

TimeGpsPps							
Byte Offset	0	1	2	3	4	5	6 7
Type	uint64						

5.5 Binary Group 2 – Time Outputs

Binary group 2 provides all timing and event counter related outputs. Some of these outputs (such as the TimeGps, TimePps, and TimeUtc), require either that the internal GNSS to be enabled, or an external GNSS must be present.

Binary Group 2

Name	Bit Offset	Description
TimeStartup	0	Time since startup.
TimeGps	1	Absolute GPS time.
GpsTow	2	Time since start of GPS week.
GpsWeek	3	GPS week.
TimeSyncln	4	Time since last Syncln trigger.
TimePPS	5	Time since last GPS PPS trigger.
TimeUTC	6	UTC time.
SynclnCnt	7	Syncln trigger count.
SyncOutCnt	8	SyncOut trigger count.
TimeStatus	9	Time valid status flags.
Resv	10-15	Reserved for future use. Should be set to zero.

5.5.1 TimeStartup

The system time since startup measured in nano seconds. The time since startup is based upon the internal TXCO oscillator for the MCU. The accuracy of the internal TXCO is +/- 20ppm (-40C to 85C).

TimeStartup	
Byte Offset	0 1 2 3 4 5 6 7
Type	uint64

5.5.2 TimeGps

The absolute GPS time since start of GPS epoch 1980 expressed in nano seconds.

TimeGps	
Byte Offset	0 1 2 3 4 5 6 7
Type	uint64

5.5.3 GpsTow

The time since the start of the current GPS time week expressed in nano seconds.

GpsTow	
Byte Offset	0 1 2 3 4 5 6 7
Type	uint64

5.5.4 GpsWeek

The current GPS week.

GpsWeek	
Byte Offset	0 1
Type	u16

5.5.5 TimeSyncIn

The time since the last SyncIn event trigger expressed in nano seconds.

TimeSyncIn								
Byte Offset	0	1	2	3	4	5	6	7
Type	uint64							

5.5.6 TimeGpsPps

The time since the last GPS PPS trigger event expressed in nano seconds.

TimePps								
Byte Offset	0	1	2	3	4	5	6	7
Type	uint64							

5.5.7 TimeUtc

The current UTC time. The year is given as a signed byte year offset from the year 2000. For example the year 2013 would be given as year 13.

TimeUtc								
Fields	year	month	day	hour	min	sec	ms	
Byte Offset	0	1	2	3	4	5	6	7
Type	s8	u8	u8	u8	u8	u8	u16	

5.5.8 SyncInCnt

The number of SyncIn trigger events that have occurred.

SyncInCnt				
Byte Offset	0	1	2	3
Type	u32			

5.5.9 SyncOutCnt

The number of SyncOut trigger events that have occurred.

SyncOutCnt				
Byte Offset	0	1	2	3
Type	u32			

5.5.10 TimeStatus

Time valid status flags.

TimeStatus	
Byte Offset	0
Type	u8

TimeStatus – Bit Flags								
Fields	timeOk	dateOk	utcTimeValid	resv	resv	resv	resv	resv
Bit Offset	0	1	2	3	4	5	6	7

Name	Description
timeOk	1 – GpsTow is valid.
dateOk	1 – TimeGps and GpsWeek are valid.
utcTimeValid	1 – UTC time is valid.
resv	Reserved for future use.

5.6 Binary Group 3 – IMU Outputs

Binary group 3 provides all outputs which are dependent upon the measurements collected from the onboard IMU, or an external IMU (if enabled).

Binary Group 3

Name	Bit Offset	Description
ImuStatus	0	Reserved for future use.
UncompMag	1	Uncompensated magnetic measurement.
UncompAccel	2	Uncompensated acceleration measurement.
UncompGyro	3	Uncompensated angular rate measurement.
Temp	4	Temperature measurement.
Pres	5	Pressure measurement.
DeltaTheta	6	Delta theta angles.
DeltaV	7	Delta velocity.
Mag	8	Compensated magnetic measurement.
Accel	9	Compensated acceleration measurement.
AngularRate	10	Compensated angular rate measurement.
Resv	11-15	Reserved for future use. Should be set to zero.

5.6.1 ImuStatus

Status is reserved for future use. Not currently used in the current code, as such will always report 0.

		ImuStatus	
Byte Offset		0	1
Type		u16	

5.6.2 UncompMag

The IMU magnetic field measured in units of Gauss, given in the body frame. This measurement is compensated by the static calibration (individual factory calibration stored in flash), and the user compensation, however it is not compensated by the onboard Hard/Soft Iron estimator.

		UncompMag											
		mag[0]				mag[1]				mag[2]			
		Body X-Axis				Body Y-Axis				Body Z-Axis			
Byte Offset		0	1	2	3	4	5	6	7	8	9	10	11
Type		float				float				float			

5.6.3 UncompAccel

The IMU acceleration measured in units of m/s^2 , given in the body frame. This measurement is compensated by the static calibration (individual factory calibration stored in flash), however it is not compensated by any dynamic calibration such as bias compensation from the onboard INS Kalman filter.

		UncompAccel											
		accel[0]				accel[1]				accel[2]			
		Body X-Axis				Body Y-Axis				Body Z-Axis			
Byte Offset		0	1	2	3	4	5	6	7	8	9	10	11
Type		float				float				float			

5.6.4 UncompGyro

The IMU angular rate measured in units of rad/s, given in the body frame. This measurement is compensated by the static calibration (individual factory calibration stored in flash), however it is not compensated by any dynamic calibration such as the bias compensation from the onboard AHRS/INS Kalman filters.

		UncompGyro											
		gyro[0]				gyro[1]				gyro[2]			
		Body X-Axis				Body Y-Axis				Body Z-Axis			
Byte Offset		0	1	2	3	4	5	6	7	8	9	10	11
Type		float				float				float			

5.6.5 Temp

The IMU temperature measured in units of Celsius.

		Temp			
Byte Offset		0	1	2	3
Type		float			

5.6.6 Pres

The IMU pressure measured in kilopascals. This is an absolute pressure measurement. Typical pressure at sea level would be around 100 kPa.

		Pres			
Byte Offset		0	1	2	3
Type		float			

5.6.7 DeltaTheta

The delta time (dtime) is the time interval that the delta angle and velocities are integrated over. The delta theta (dtheta) is the delta rotation angles incurred due to rotation, by the local body reference frame, since the last time the values were outputted by the device. The delta velocity (dvel) is the delta velocity incurred due to motion, by the local body reference frame, since the last time the values were outputted by the device. The frame of reference of these delta measurements are determined by the IntegrationFrame field in the Delta Theta and Delta Velocity Configuration Register (Register 82). These delta angles and delta velocities are calculated based upon the onboard coning and sculling integration performed onboard the sensor at the full IMU rate (default 800Hz). The integration for both the delta angles and velocities are reset each time either of the values are either polled or sent out due to a scheduled asynchronous ASCII or binary output. Delta Theta and Delta Velocity values correctly capture the nonlinearities involved in measuring motion from a rotating strapdown platform (as opposed to the older mechanically inertial navigation systems), thus providing you with the ability to integrate velocity and angular rate at much lower speeds (say for example 10 Hz, reducing bandwidth and computational complexity), while still maintaining the same numeric precision as if you had performed the integration at the full IMU measurement rate of 800Hz. Time is given in seconds. Delta angles are given in degrees.

		DeltaTheta															
Fields		dtime				dtheta[0]				dtheta[1]				dtheta[2]			
						X-Axis				Y-Axis				Z-Axis			
		sec				deg				deg				deg			
Byte Offset		0	1	2	3	4	5	6	7	8	9	10	11	12	13	14	15
Type		float				float				float				float			

5.6.8 DeltaV

The delta velocity (dvel) is the delta velocity incurred due to motion, since the last time the values were output by the device. The delta velocities are calculated based upon the onboard conning and sculling integration performed onboard the sensor at the IMU sampling rate (nominally 800Hz). The integration for the delta velocities are reset each time the values are either polled or sent out due to a scheduled asynchronous ASCII or binary output. Delta velocity is given in meters per second.

		DeltaVel											
Fields		dvel[0]				dvel[1]				dvel[2]			
		X-Axis				Y-Axis				Z-Axis			
		m/s				m/s				m/s			
Byte Offset		0	1	2	3	4	5	6	7	8	9	10	11
Type		float				float				float			

5.6.9 Mag

The IMU compensated magnetic field measured units of Gauss, and given in the body frame. This measurement is compensated by the static calibration (individual factory calibration stored in flash), the user compensation, and the dynamic calibration from the onboard Hard/Soft Iron estimator.

		Mag											
Fields		mag[0]				mag[1]				mag[2]			
		Body X-Axis				Body Y-Axis				Body Z-Axis			
Byte Offset		0	1	2	3	4	5	6	7	8	9	10	11
Type		float				float				float			

5.6.10 Accel

The compensated acceleration measured in units of m/s², and given in the body frame. This measurement is compensated by the static calibration (individual factory calibration stored in flash), the user compensation, and the dynamic bias compensation from the onboard INS Kalman filter.

		Accel											
Fields		accel[0]				accel[1]				accel[2]			
		Body X-Axis				Body Y-Axis				Body Z-Axis			
Byte Offset		0	1	2	3	4	5	6	7	8	9	10	11
Type		float				float				float			

5.6.11 AngularRate

The compensated angular rate measured in units of rad/s, and given in the body frame. This measurement is compensated by the static calibration (individual factor calibration stored in flash), the user compensation, and the dynamic bias compensation from the onboard INS Kalman filter.

		AngularRate											
		gyro[0]				gyro[1]				gyro[2]			
		Body X-Axis				Body Y-Axis				Body Z-Axis			
Byte Offset		0	1	2	3	4	5	6	7	8	9	10	11
Type		float				float				float			

5.7 Binary Group 4 – GNSS1 Outputs

Binary group 4 provides all outputs which are dependent upon the measurements collected from the primary onboard GNSS, or external GNSS (if enabled). All data in this group is updated at the rate of the GNSS receiver (nominally 5Hz for the internal GNSS).



If data is asynchronously sent from group 4 at a rate equal to the GNSS update rate, then packets will be sent out when updated by the GNSS receiver. For all other rates, the output will be based on the divisor selected and the internal IMU sampling rate.

Binary Group 4

Name	Bit Offset	Description
UTC	0	GPS UTC Time
Tow	1	GPS time of week
Week	2	GPS week
NumSats	3	Number of tracked satellites
Fix	4	GNSS fix
PosLla	5	GNSS position (latitude, longitude, altitude)
PosEcef	6	GNSS position (ECEF)
VelNed	7	GNSS velocity (NED)
VelEcef	8	GNSS velocity (ECEF)
PosU	9	GNSS position uncertainty (NED)
VelU	10	GNSS velocity uncertainty
TimeU	11	GNSS time uncertainty
TimeInfo	12	GNSS time status and leap seconds
DOP	13	Dilution of precision values
SatInfo	14	Satellite Information
Raw	15	GNSS Raw Measurements.

5.7.1 UTC

The current UTC time. The year is given as a signed byte year offset from the year 2000. For example the year 2013 would be given as year 13.

UTC							
Fields	year	month	day	hour	min	sec	ms
Byte Offset	0	1	2	3	4	5	6 7
Type	s8	u8	u8	u8	u8	u8	u16

5.7.2 Tow

The GPS time of week given in nano seconds.

Tow							
Byte Offset	0	1	2	3	4	5	6 7
Type	uint64						

5.7.3 Week

The current GPS week.

Week	
Byte Offset	0 1
Type	u16

5.7.4 NumSats

The number of tracked GNSS satellites.

NumSats	
Byte Offset	0
Type	u8

5.7.5 Fix

The current GNSS fix.

Fix	
Byte Offset	0
Type	u8

Table 1 - GNSS Fix

Value	Description
0	No fix
1	Time only
2	2D
3	3D

5.7.6 PosLla

The current GNSS position measurement given as the geodetic latitude, longitude and altitude above the ellipsoid. The units are in [deg, deg, m] respectively.

PosLla																									
		latitude							longitude							altitude									
Byte Offset		0	1	2	3	4	5	6	7	8	9	10	11	12	13	14	15	16	17	18	19	20	21	22	23
Type		double							double							double									

5.7.7 PosEcef

The current GNSS position given in the Earth centered Earth fixed (ECEF) coordinate frame, given in meters.

		PosEcef																							
		pos[0]							pos[1]							pos[2]									
Byte Offset	Type	0	1	2	3	4	5	6	7	8	9	10	11	12	13	14	15	16	17	18	19	20	21	22	23
		double							double							double									

5.7.8 VelNed

The current GNSS velocity in the North East Down (NED) coordinate frame, given in m/s.

		VelNed											
		vel[0]				vel[1]				vel[2]			
		North Axis				East Axis				Down Axis			
Byte Offset	Type	0	1	2	3	4	5	6	7	8	9	10	11
		float				float				float			

5.7.9 VelEcef

The current GNSS velocity in the Earth centered Earth fixed (ECEF) coordinate frame, given in m/s.

		VelEcef											
		vel[0]				vel[1]				vel[2]			
		X-Axis				Y-Axis				Z-Axis			
Byte Offset	Type	0	1	2	3	4	5	6	7	8	9	10	11
		float				float				float			

5.7.10 PosU

The current GNSS position uncertainty in the North East Down (NED) coordinate frame, given in meters (1 Sigma).

		PosU											
		posU[0]				posU[1]				posU[2]			
		North Axis				East Axis				Down Axis			
Byte Offset	Type	0	1	2	3	4	5	6	7	8	9	10	11
		float				float				float			

5.7.11 VelU

The current GNSS velocity uncertainty, given in m/s (1 Sigma).

		VelU			
Byte Offset	Type	0	1	2	3
		float			

5.7.12 TimeU

The current GNSS time uncertainty, given in seconds (1 Sigma).

		TimeU			
Byte Offset		0	1	2	3
Type		float			

5.7.13 TimeInfo

Flags for valid GPS TOW, week number and UTC and current leap seconds.

		TimeInfo	
Byte Offset		Status	LeapSeconds
Type		0	1
		u8	s8

		TimeInfo Status – Bit Flags						
Fields		timeOk	dateOk	utcTimeValid	resv	resv	resv	resv
Bit Offset		0	1	2	3	4	5	6

Name	Description
timeOk	1 – GpsTow is valid.
dateOk	1 – TimeGps and GpsWeek are valid.
utcTimeValid	1 – UTC time is valid.
resv	Reserved for future use.

5.7.14 DOP

Dilution of precision

		DOP																							
Fields		gDOP				pDOP				tDOP				vDOP				hDOP				nDOP			
Byte Offset		0	1	2	3	4	5	6	7	8	9	10	11	12	13	14	15	16	17	18	19	20	21	22	23
Type		float				float				float				float				float				float			

		DOP (continued)			
Fields		eDOP			
Byte Offset		24	25	26	27
Type		float			

5.7.15 SatInfo

Information and measurements pertaining to each GNSS satellite in view.

		SatInfo																
Fields	numSats	resv	Sat Info - Satellite 1							Sat Info – Satellite 2								
Byte Offset	0	1	2	3	4	5	6	7	8	9	10	11	12	13	14	15	16	17
Type	u8	u8	struct – see below definition							struct – see below definition								

		SatInfo Element						
Fields	sys	svId	flags	cno	qi	el	az	
Byte Offset	0	1	2	3	4	5	6	7
Type	s8	u8	u8	u8	u8	s8	s16	

Table 2 - SatInfo

Name	Description
numSats	Number of measurements to follow.
resv	Reserved for future use.

Table 3 - SatRaw Element

Name	Description
sys	GNSS constellation indicator. See table below for details.
svId	Space vehicle Id
flags	Tracking info flags. See table below for details.
cno	Carrier-to-noise density ratio (signal strength) [dB-Hz]
qi	Quality Indicator. See table below for details.
el	Elevation in degrees
az	Azimuth angle in degrees

Table 4 - Flags Field

Bit Offset	Description
0	Healthy
1	Almanac
2	Ephemeris
3	Differential Correction
4	Used for Navigation
5	Azimuth / Elevation Valid
6	Used for RTK

Table 5 - Quality Indicator

Value	Description
0	No signal
1	Searching signal
2	Signal acquired
3	Signal detected but unstable
4	Code locked and time synchronized
5,6,7	Code and carrier locked and time synchronized

The size of this packet will vary depending upon the number of satellites in view. To parse this packet you will first need to read the number of satellites (numSats) in the beginning of the packet to determine the packets overall length. The total length of the packet payload will be $2 + N*8$ bytes where N is the number of satellites (numSats).

5.7.16 RawMeas

Raw measurements pertaining to each GNSS satellite in view.

		RawMeas					
Fields		tow	week	numSats	resv	SatRaw - Satellite 1	SatRaw – Satellite 2
Byte Offset		0-7	8-9	10	11	12-39	40-67
Type		double	u16	u8	u8	struct – see below definition	struct – see below definition

		SatRaw Element										
Fields		sys	svId	freq	chan	slot	cno	flags	pr	cp	dp	
Byte Offset		0	1	2	3	4	5	6	7	8-15	16-23	24-27
Type		u8	u8	u8	u8	s8	u8	u16	double	double	float	

Table 6 - RawMeas

Name	Description
tow	Time of week in seconds.
week	GPS week number.
numSats	Number of measurements to follow.

Table 7 - SatRaw Element

Name	Description
sys	GNSS constellation indicator. See table below for details.
svld	Space vehicle Id.
freq	Frequency indicator. See table below for details.
chan	Channel Indicator. See table below for details.
slot	Slot Id
cno	Carrier-to-noise density ratio (signal strength) [dB-Hz]
flags	Tracking info flags. See table below for details.
pr	Pseudorange measurement in meters.
cp	Carrier phase measurement in cycles.
dp	Doppler measurement in Hz. Positive sign for approaching satellites.

Table 8 - Sys Field

Value	Description
0	GPS
1	SBAS
2	Galileo
3	BeiDou
4	IMES
5	QZSS
6	GLONASS

Table 9 - Freq Field

Value	Description
0	Rx Channel
1	L1(GPS,QZSS,SBAS), G1(GLO), E2-L1-E1(GAL), B1(BDS)
2	L2(GPS,QZSS), G2(GLO)
3	L5(GPS,QZSS,SBAS), E5a(GAL)
4	E6(GAL), LEX(QZSS), B3(BDS)
5	E5b(GAL), B2(BDS)
6	E5a+b(GAL)

Table 10 - Chan Field

Value	Description
0	P-code (GPS,GLO)
1	C/A-code (GPS,GLO,SBAS,QZSS), C chan (GAL)
2	semi-codeless (GPS)
3	Y-code (GPS)
4	M-code (GPS)
5	codeless (GPS)
6	A chan (GAL)
7	B chan (GAL)
8	I chan (GPS,GAL,QZSS,BDS)
9	Q chan (GPS,GAL,QZSS,BDS)
10	M chan (L2CGPS, L2CQZSS), D chan (GPS,QZSS)
11	L chan (L2CGPS, L2CQZSS), P chan (GPS,QZSS)
12	B+C chan (GAL), I+Q chan (GPS,GAL,QZSS,BDS), M+L chan (GPS,QZSS), D+P chan (GPS,QZSS)
13	based on Z-tracking (GPS)
14	A+B+C (GAL)

Table 11 - Flags Field

Bit Offset	Description
0	Searching
1	Tracking
2	Time Valid
3	Code Lock
4	Phase Lock
5	Phase Half Ambiguity
6	Phase Half Sub
7	Phase Slip
8	Pseudorange Smoothed

The size of this packet will vary depending upon the number of satellites in view. To parse this packet you will first need to read the number of satellites (numSats) in the beginning of the packet to determine the packets overall length. The total length of the packet payload will be $12 + (N*28)$ bytes where N is the number of satellites (numSats).

5.8 Binary Group 5 – Attitude Outputs

Binary group 5 provides all estimated outputs which are dependent upon the estimated attitude solution. The attitude will be derived from either the AHRS or the INS, depending upon which filter is currently active and tracking. All of the fields in this group will only be valid if the AHRS/INS filter is currently enabled and tracking.

Binary Group 5

Name	Bit Offset	Description
Reserved	0	Reserved. Not used on this product.
Ypr	1	Yaw Pitch Roll
Qtn	2	Quaternion
DCM	3	Directional Cosine Matrix
MagNed	4	Compensated magnetic (NED)
AccelNed	5	Compensated acceleration (NED)
LinearAccelBody	6	Compensated linear acceleration (no gravity)
LinearAccelNed	7	Compensated linear acceleration (no gravity) (NED)
YprU	8	Yaw Pitch Roll uncertainty
Resv	9-15	Reserved for future use. Should be set to zero.

5.8.1 YawPitchRoll

The estimated attitude Yaw, Pitch, and Roll angles measured in degrees. The attitude is given as a 3,2,1 Euler angle sequence describing the body frame with respect to the local North East Down (NED) frame.

		YawPitchRoll											
		yaw				pitch				roll			
Byte Offset		0	1	2	3	4	5	6	7	8	9	10	11
Type		float				float				Float			

Name	Range
Yaw	+/- 180°
Pitch	+/- 90°
Roll	+/-180°

5.8.2 Quaternion

The estimated attitude quaternion. The last term is the scalar value. The attitude is given as the body frame with respect to the local North East Down (NED) frame.

		Quaternion															
		qtn[0]				qtn[1]				qtn[2]				qtn[3]			
Byte Offset		0	1	2	3	4	5	6	7	8	9	10	11	12	13	14	15
Type		float				float				float				float			

5.8.3 DCM

The estimated attitude directional cosine matrix given in column major order. The DCM maps vectors from the North East Down (NED) frame into the body frame.

		Dcm																							
Fields		dcm[0]				dcm[1]				dcm[2]				dcm[3]				dcm[4]				dcm[5]			
Byte Offset		0	1	2	3	4	5	6	7	8	9	10	11	12	13	14	15	16	17	18	19	20	21	22	23
Type		float				float				float				float				float							

		Dcm (continued)											
Fields		dcm[6]				dcm[7]				dcm[8]			
Byte Offset		24	25	26	27	28	29	30	31	32	33	34	35
Type		float				float				float			

5.8.4 MagNed

The current estimated magnetic field (Gauss), given in the North East Down (NED) frame. The current attitude solution is used to map the measurement from the measured body frame to the inertial (NED) frame. This measurement is compensated by both the static calibration (individual factory calibration stored in flash), and the dynamic calibration such as the user or onboard Hard/Soft Iron compensation registers.

		MagNed											
		mag[0]				mag[1]				mag[2]			
		North Axis				East Axis				Down Axis			
Byte Offset		0	1	2	3	4	5	6	7	8	9	10	11
Type		float				float				float			

5.8.5 AccelNed

The estimated acceleration (with gravity) reported in m/s^2 , given in the North East Down (NED) frame. The acceleration measurement has been bias compensated by the onboard INS filter. This measurement is attitude dependent, since the attitude is used to map the measurement from the body frame into the inertial (NED) frame. If the device is stationary and the INS filter is tracking, the measurement should be nominally equivalent to the gravity reference vector in the inertial frame (NED).

		AccelNed											
		accel[0]				accel[1]				accel[2]			
		North Axis				East Axis				Down Axis			
Byte Offset		0	1	2	3	4	5	6	7	8	9	10	11
Type		float				float				float			

5.8.6 LinearAccelBody

The estimated linear acceleration (without gravity) reported in m/s^2 , and given in the body frame. The acceleration measurement has been bias compensated by the onboard INS filter, and the gravity

component has been removed using the current gravity reference vector model. This measurement is attitude dependent, since the attitude solution is required to map the gravity reference vector (known in the inertial NED frame), into the body frame so that it can be removed from the measurement. If the device is stationary and the onboard INS filter is tracking, the measurement nominally will read 0 in all three axes.

		LinearAccelBody											
		accel[0]				accel[1]				accel[2]			
		Body X-Axis				Body Y-Axis				Body Z-Axis			
Byte Offset		0	1	2	3	4	5	6	7	8	9	10	11
Type		float				float				float			

5.8.7 LinearAccelNed

The estimated linear acceleration (without gravity) reported in m/s^2 , and given in the North East Down (NED) frame. This measurement is attitude dependent as the attitude solution is used to map the measurement from the body frame into the inertial (NED) frame. This acceleration measurement has been bias compensated by the onboard INS filter, and the gravity component has been removed using the current gravity reference vector estimate. If the device is stationary and the onboard INS filter is tracking, the measurement nominally will read 0 in all three axes.

		LinearAccelNed											
		accel[0]				accel[1]				accel[2]			
		North Axis				East Axis				Down Axis			
Byte Offset		0	1	2	3	4	5	6	7	8	9	10	11
Type		float				float				float			

5.8.8 YprU

The estimated attitude (Yaw, Pitch, Roll) uncertainty (1 Sigma), reported in degrees.

		YprU											
		yaw				pitch				roll			
Byte Offset		0	1	2	3	4	5	6	7	8	9	10	11
Type		float				float				float			



The estimated attitude (YprU) field is not valid when the INS Scenario mode in the INS Basic Configuration register is set to AHRS mode. See the INS Basic Configuration Register in the INS section for more details.

5.9 Binary Group 6 – INS Outputs

Binary group 6 provides all estimated outputs which are dependent upon the onboard INS state solution. All of the fields in this group will only be valid if the INS filter is currently enabled and tracking.

Binary Group 6

Name	Bit Offset	Description
InsStatus	0	Ins Status
PosLla	1	Ins Position (latitude, longitude, altitude)
PosEcef	2	Ins Position (ECEF)
VelBody	3	Ins Velocity (Body)
VelNed	4	Ins Velocity (NED)
VelEcef	5	Ins Velocity (ECEF)
MagEcef	6	Compensated magnetic (ECEF)
AccelEcef	7	Compensated acceleration (ECEF)
LinearAccelEcef	8	Compensated linear acceleration (no gravity) (ECEF)
PosU	9	Ins Position Uncertainty
VelU	10	Ins Velocity Uncertainty
Resv	11-15	Reserved for future use. Should be set to zero.

5.9.1 InsStatus

The INS status bitfield. See the INS Solution - LLA Register in the INS subsystem for more information on the individual bits in this field.

		InsStatus	
Byte Offset		0	1
Type		u16	

5.9.2 PosLla

The estimated position given as latitude, longitude, and altitude given in [deg, deg, m] respectively.

		PosLla																							
		latitude							longitude								altitude								
Byte Offset		0	1	2	3	4	5	6	7	8	9	10	11	12	13	14	15	16	17	18	19	20	21	22	23
Type		double							double								double								

5.9.3 PosEcef

The estimated position given in the Earth centered Earth fixed (ECEF) frame, reported in meters.

PosEcef																								
pos[0]								pos[1]								pos[2]								
X-Axis								Y-Axis								Z-Axis								
Byte	0	1	2	3	4	5	6	7	8	9	10	11	12	13	14	15	16	17	18	19	20	21	22	23
Offset																								
Type	double								double								double							

5.9.4 VelBody

The estimated velocity in the body frame, given in m/s.

VelBody												
vel[0]				vel[1]				vel[2]				
Body X-Axis				Body Y-Axis				Body Z-Axis				
Byte	0	1	2	3	4	5	6	7	8	9	10	11
Offset												
Type	float				float				float			

5.9.5 VelNed

The estimated velocity in the North East Down (NED) frame, given in m/s.

VelNed												
vel[0]				vel[1]				vel[2]				
North Axis				East Axis				Down Axis				
Byte	0	1	2	3	4	5	6	7	8	9	10	11
Offset												
Type	float				float				float			

5.9.6 VelEcef

The estimated velocity in the Earth centered Earth fixed (ECEF) frame, given in m/s.

VelEcef												
vel[0]				vel[1]				vel[2]				
ECEF X-Axis				ECEF Y-Axis				ECEF Z-Axis				
Byte	0	1	2	3	4	5	6	7	8	9	10	11
Offset												
Type	float				float				float			

5.9.7 MagEcef

The compensated magnetic measurement in the Earth centered Earth fixed (ECEF) frame, given in Gauss.

MagEcef												
mag[0]				mag[1]				mag[2]				
ECEF X-Axis				ECEF Y-Axis				ECEF Z-Axis				
Byte	0	1	2	3	4	5	6	7	8	9	10	11
Offset												
Type	float				float				float			

5.9.8 AccelEcef

The estimated acceleration (with gravity) reported in m/s^2 , given in the Earth centered Earth fixed (ECEF) frame. The acceleration measurement has been bias compensated by the onboard INS filter. This measurement is attitude dependent, since the attitude is used to map the measurement from the body frame into the inertial (ECEF) frame. If the device is stationary and the INS filter is tracking, the measurement should be nominally equivalent to the gravity reference vector in the inertial frame (ECEF).

		AccelEcef											
		accel[0]				accel[1]				accel[2]			
		ECEF X-Axis				ECEF Y-Axis				ECEF Z-Axis			
Byte Offset		0	1	2	3	4	5	6	7	8	9	10	11
Type		float				float				float			

5.9.9 LinearAccelEcef

The estimated linear acceleration (without gravity) reported in m/s^2 , and given in the Earth centered Earth fixed (ECEF) frame. This measurement is attitude dependent as the attitude solution is used to map the measurement from the body frame into the inertial (ECEF) frame. This acceleration measurement has been bias compensated by the onboard INS filter, and the gravity component has been removed using the current gravity reference vector estimate. If the device is stationary and the onboard INS filter is tracking, the measurement will nominally read 0 in all three axes.

		LinearAccelEcef											
		accel[0]				accel[1]				accel[2]			
		ECEF X-Axis				ECEF Y-Axis				ECEF Z-Axis			
Byte Offset		0	1	2	3	4	5	6	7	8	9	10	11
Type		float				float				float			

5.9.10 PosU

The estimated uncertainty (1 Sigma) in the current position estimate, given in meters.

		PosU			
Byte Offset		0	1	2	3
Type		float			

5.9.11 VelU

The estimated uncertainty (1 Sigma) in the current velocity estimate, given in m/s .

		VelU			
Byte Offset		0	1	2	3
Type		float			

5.10 Binary Group 7 – GNSS2 Outputs

Binary group 7 provides all outputs which are dependent upon the measurements collected from the secondary onboard GNSS, or external GNSS (if enabled). All data in this group is updated at the rate of the GNSS receiver (nominally 5Hz for the internal GNSS).



If data is asynchronously sent from group 7 at a rate equal to the GNSS update rate, then packets will be sent out when updated by the GNSS receiver. For all other rates, the output will be based on the divisor selected and the internal IMU sampling rate.

Binary Group 7

Name	Bit Offset	Description
UTC	0	GPS UTC Time
Tow	1	GPS time of week
Week	2	GPS week
NumSats	3	Number of tracked satellites
Fix	4	GNSS fix
PosLla	5	GNSS position (latitude, longitude, altitude)
PosEcef	6	GNSS position (ECEF)
VelNed	7	GNSS velocity (NED)
VelEcef	8	GNSS velocity (ECEF)
PosU	9	GNSS position uncertainty (NED)
VelU	10	GNSS velocity uncertainty
TimeU	11	GNSS time uncertainty
TimeInfo	12	GNSS time status and leap seconds
DOP	13	Dilution of precision values
SatInfo	14	Satellite Information
Raw	15	GNSS Raw Measurements.

5.10.1 UTC

The current UTC time. The year is given as a signed byte year offset from the year 2000. For example the year 2013 would be given as year 13.

UTC							
Fields	year	month	day	hour	min	sec	ms
Byte Offset	0	1	2	3	4	5	6 7
Type	s8	u8	u8	u8	u8	u8	u16

5.10.2 Tow

The GPS time of week given in nano seconds.

Tow							
Byte Offset	0	1	2	3	4	5	6 7
Type	uint64						

5.10.3 Week

The current GPS week.

Week	
Byte Offset	0 1
Type	u16

5.10.4 NumSats

The number of tracked GNSS satellites.

NumSats	
Byte Offset	0
Type	u8

5.10.5 Fix

The current GNSS fix.

Fix	
Byte Offset	0
Type	u8

Table 12 - GNSS Fix

Value	Description
0	No fix
1	Time only
2	2D
3	3D

5.10.6 PosLla

The current GNSS position measurement given as the geodetic latitude, longitude and altitude above the ellipsoid. The units are in [deg, deg, m] respectively.

PosLla																									
		latitude							longitude							altitude									
Byte Offset		0	1	2	3	4	5	6	7	8	9	10	11	12	13	14	15	16	17	18	19	20	21	22	23
Type		double							double							double									

5.10.7 PosEcef

The current GNSS position given in the Earth centered Earth fixed (ECEF) coordinate frame, given in meters.

		PosEcef																							
		pos[0]							pos[1]							pos[2]									
Byte Offset	Type	0	1	2	3	4	5	6	7	8	9	10	11	12	13	14	15	16	17	18	19	20	21	22	23
		double							double							double									

5.10.8 VelNed

The current GNSS velocity in the North East Down (NED) coordinate frame, given in m/s.

		VelNed											
		vel[0]				vel[1]				vel[2]			
		North Axis				East Axis				Down Axis			
Byte Offset	Type	0	1	2	3	4	5	6	7	8	9	10	11
		float				float				float			

5.10.9 VelEcef

The current GNSS velocity in the Earth centered Earth fixed (ECEF) coordinate frame, given in m/s.

		VelEcef											
		vel[0]				vel[1]				vel[2]			
		ECEF X-Axis				ECEF Y-Axis				ECEF Z-Axis			
Byte Offset	Type	0	1	2	3	4	5	6	7	8	9	10	11
		float				float				float			

5.10.10 PosU

The current GNSS position uncertainty in the North East Down (NED) coordinate frame, given in meters (1 Sigma).

		PosU											
		posU[0]				posU[1]				posU[2]			
		North Axis				East Axis				Down Axis			
Byte Offset	Type	0	1	2	3	4	5	6	7	8	9	10	11
		float				float				float			

5.10.11 VelU

The current GNSS velocity uncertainty, given in m/s (1 Sigma).

		VelU			
Byte Offset	Type	0	1	2	3
		float			

5.10.12 TimeU

The current GNSS time uncertainty, given in seconds (1 Sigma).

		TimeU			
Byte Offset		0	1	2	3
Type		float			

5.10.13 TimeInfo

Flags for valid GPS TOW, week number and UTC and current leap seconds.

		TimeInfo	
Byte Offset		Status	LeapSeconds
		0	1
Type		u8	s8

		TimeInfo Status – Bit Flags							
Fields		timeOk	dateOk	utcTimeValid	resv	resv	resv	resv	resv
Bit Offset		0	1	2	3	4	5	6	7

Name	Description
timeOk	1 – GpsTow is valid.
dateOk	1 – TimeGps and GpsWeek are valid.
utcTimeValid	1 – UTC time is valid.
resv	Reserved for future use.

5.10.14 DOP

Dilution of precision

		DOP																							
Fields		gDOP				pDOP				tDOP				vDOP				hDOP				nDOP			
Byte Offset		0	1	2	3	4	5	6	7	8	9	10	11	12	13	14	15	16	17	18	19	20	21	22	23
Type		float				float				float				float				float				float			

		DOP (continued)			
Fields		eDOP			
Byte Offset		24	25	26	27
Type		float			

5.10.15 SatInfo

Information and measurements pertaining to each GNSS satellite in view.

		SatInfo																
Fields	numSats	resv	Sat Info - Satellite 1							Sat Info – Satellite 2								
Byte Offset	0	1	2	3	4	5	6	7	8	9	10	11	12	13	14	15	16	17
Type	u8	u8	struct – see below definition							struct – see below definition								

		SatInfo Element						
Fields	sys	svId	flags	cno	qi	el	az	
Byte Offset	0	1	2	3	4	5	6	7
Type	s8	u8	u8	u8	u8	s8	s16	

Table 13 - SatInfo

Name	Description
numSats	Number of measurements to follow.
resv	Reserved for future use.

Table 14 - SatRaw Element

Name	Description
sys	GNSS constellation indicator. See table below for details.
svId	Space vehicle Id
flags	Tracking info flags. See table below for details.
cno	Carrier-to-noise density ratio (signal strength) [dB-Hz]
qi	Quality Indicator. See table below for details.
el	Elevation in degrees
az	Azimuth angle in degrees

Table 15 - Flags Field

Bit Offset	Description
0	Healthy
1	Almanac
2	Ephemeris
3	Differential Correction
4	Used for Navigation
5	Azimuth / Elevation Valid
6	Used for RTK

Table 16 - Quality Indicator

Value	Description
0	No signal
1	Searching signal
2	Signal acquired
3	Signal detected but unstable
4	Code locked and time synchronized
5,6,7	Code and carrier locked and time synchronized

The size of this packet will vary depending upon the number of satellites in view. To parse this packet you will first need to read the number of satellites (numSats) in the beginning of the packet to determine the packets overall length. The total length of the packet payload will be 2 + N*8 bytes where N is the number of satellites (numSats).

5.10.16 RawMeas

Raw measurements pertaining to each GNSS satellite in view.

		RawMeas					
Fields		tow	week	numSats	resv	SatRaw - Satellite 1	SatRaw – Satellite 2
Byte Offset		0-7	8-9	10	11	12-39	40-67
Type		double	u16	u8	u8	struct – see below definition	struct – see below definition

		SatRaw Element										
Fields		sys	svId	freq	chan	slot	cno	flags		pr	cp	dp
Byte Offset		0	1	2	3	4	5	6	7	8-15	16-23	24-27
Type		u8	u8	u8	u8	s8	u8	u16		double	double	float

Table 17 - RawMeas

Name	Description
tow	Time of week in seconds.
week	GPS week number.
numSats	Number of measurements to follow.

Table 18 - SatRaw Element

Name	Description
sys	GNSS constellation indicator. See table below for details.
svld	Space vehicle Id.
freq	Frequency indicator. See table below for details.
chan	Channel Indicator. See table below for details.
slot	Slot Id
cno	Carrier-to-noise density ratio (signal strength) [dB-Hz]
flags	Tracking info flags. See table below for details.
pr	Pseudorange measurement in meters.
cp	Carrier phase measurement in cycles.
dp	Doppler measurement in Hz. Positive sign for approaching satellites.

Table 19 - Sys Field

Value	Description
0	GPS
1	SBAS
2	Galileo
3	BeiDou
4	IMES
5	QZSS
6	GLONASS

Table 20 - Freq Field

Value	Description
0	Rx Channel
1	L1(GPS,QZSS,SBAS), G1(GLO), E2-L1-E1(GAL), B1(BDS)
2	L2(GPS,QZSS), G2(GLO)
3	L5(GPS,QZSS,SBAS), E5a(GAL)
4	E6(GAL), LEX(QZSS), B3(BDS)
5	E5b(GAL), B2(BDS)
6	E5a+b(GAL)

Table 21 - Chan Field

Value	Description
0	P-code (GPS,GLO)
1	C/A-code (GPS,GLO,SBAS,QZSS), C chan (GAL)
2	semi-codeless (GPS)
3	Y-code (GPS)
4	M-code (GPS)
5	codeless (GPS)
6	A chan (GAL)
7	B chan (GAL)
8	I chan (GPS,GAL,QZSS,BDS)
9	Q chan (GPS,GAL,QZSS,BDS)
10	M chan (L2CGPS, L2CQZSS), D chan (GPS,QZSS)
11	L chan (L2CGPS, L2CQZSS), P chan (GPS,QZSS)
12	B+C chan (GAL), I+Q chan (GPS,GAL,QZSS,BDS), M+L chan (GPS,QZSS), D+P chan (GPS,QZSS)
13	based on Z-tracking (GPS)
14	A+B+C (GAL)

Table 22 - Flags Field

Bit Offset	Description
0	Searching
1	Tracking
2	Time Valid
3	Code Lock
4	Phase Lock
5	Phase Half Ambiguity
6	Phase Half Sub
7	Phase Slip
8	Pseudorange Smoothed

The size of this packet will vary depending upon the number of satellites in view. To parse this packet you will first need to read the number of satellites (numSats) in the beginning of the packet to determine the packets overall length. The total length of the packet payload will be $12 + (N*28)$ bytes where N is the number of satellites (numSats).

6 System Module

6.1 Commands

6.1.1 Read Register Command

This command allows the user to read any of the registers on the VN-300. The only required parameter is the ID of the register to be read. The first parameter of the response will contain the same register ID followed by a variable number of parameters. The number of parameters and their formatting is specific to the requested register. Refer to the appropriate register listed in the subsystem sections for details on this formatting. If an invalid register is requested, an error code will be returned.

Example Read Register Command

Example Command	Message
UART Command	\$VNRRG,5*46
UART Response	\$VNRRG,5,9600*65
SPI Command	01 05 00 00 (shown as hex)
SPI Response	00 01 05 00 80 25 00 00 (shown as hex)

6.1.2 Write Register Command

This command is used to write data values to a specified register on the VN-300 module. The ID of the register to be written to is the first parameter. This is followed by the data values specific to that register. Refer to the appropriate register listed in the subsystem sections for details on this formatting. If an invalid register is requested, an error code will be returned.

Example Write Register Command

Example Command	Message
UART Command	\$VNWRG,5,9600*60
UART Response	\$VNWRG,5,9600*60
SPI Command	02 05 00 00 80 25 00 00 (shown as hex)
SPI Response	00 02 05 00 80 25 00 00 (shown as hex)

6.1.3 Write Settings Command

This command will write the current register settings into non-volatile memory. Once the settings are stored in non-volatile (Flash) memory, the VN-300 module can be power cycled or reset, and the register will be reloaded from non-volatile memory.

Example Write Settings Command

Example Command	Message
UART Command	\$VNWNV*57
UART Response	\$VNWNV*57
SPI Command	03 00 00 00 (shown as hex)
SPI Response	00 03 00 00 (shown as hex)



Due to limitations in the flash write speed the write settings command takes ~ 500ms to complete. Any commands that are sent to the sensor during this time will be responded to after the operation is complete.



The sensor must be stationary when issuing a Write Settings Command otherwise a Reset command must also be issued to prevent the Kalman Filter from diverging during the write settings process.

6.1.4 Restore Factory Settings Command

This command will restore the VN-300 module’s factory default settings and will reset the module. There are no parameters for this command. The module will respond to this command before restoring the factory settings.

Example Restore Factory Settings Command

Example Command	Message
UART Command	\$VNRFS*5F
UART Response	\$VNRFS*5F
SPI Command	04 00 00 00 (shown as hex)
SPI Response	00 04 00 00 (shown as hex)

6.1.5 Reset Command

This command will reset the module. There are no parameters required for this command. The module will first respond to the command and will then perform a reset. Upon a reset all registers will be reloaded with the values saved in non-volatile memory. If no values are stored in non-volatile memory, the device will default to factory settings. Also upon reset the VN-300 will re-initialize its Kalman filter, thus the filter will take a few seconds to completely converge on the correct attitude and correct for gyro bias.

Example Reset Command

Example Command	Message
UART Command	\$VNRST*4D
UART Response	\$VNRST*4D
SPI Command	06 00 00 00 (shown as hex)
SPI Response	00 06 00 00 (shown as hex)

6.1.6 Firmware Update Command

This command is used to enter the boot loader for performing firmware updates. Upon receiving this command on serial port 1, the VN-300 will enter into firmware reprogramming mode. The easiest method of updating firmware is to use one of the VectorNav Firmware Update Tools. If you wish however to incorporate the ability to update the firmware into your own system, the protocol and procedure for updating the firmware is outlined in the [AN013 Firmware Update Protocol](#) application note.

Example Firmware Update Command

Example Command	Message
UART Command	\$VNFWU*XX
UART Response	\$VNFWU*XX



Firmware updates are only supported on serial port 1. If you plan on using serial port 2 as your primary means of communicating with the sensor, it is recommended that you also provide support in your design to communicate with the sensor using serial port 1 to facilitate firmware updates.

6.1.7 Serial Command Prompt Command

This command allows you to enter into the command prompt mode on either serial port. The command mode supports a wide range of diagnostics and configuration options that go beyond the abilities of the normal read/write configuration register interface.

Example Command Prompt Command

Example Command	Message
UART Command	\$VNCMD*XX
UART Response	\$VNCMD*XX

6.1.8 Asynchronous Output Pause Command

This command allows the user to temporarily pause the asynchronous outputs on the given serial port. When paused, both the ASCII and the 3 binary asynchronous output messages will temporarily stop outputting from the device on the serial port for which this command is received. The state of the asynchronous output register and the binary output configuration registers will not be changed when the asynchronous outputs are paused. This command is useful when you want to send configuration commands to the VN-300, but do not want to deal with the additional overhead of having to parse a constant stream of asynchronous output messages while waiting for the response to your configuration commands. It is also useful when you want to type commands to the device from a serial command prompt. The below example commands demonstrate how to pause and resume asynchronous outputs.

Example Asynchronous Pause/Resume Commands

Example Command	Message
Pause Async Outputs	\$VNASY,0*XX
Resume Async Outputs	\$VNASY,1*XX

6.1.9 Binary Output Poll Command

This command allows you to poll the sensor measurements available in the binary output protocol.

Example Command Prompt Command

Example Command	Message
UART Command	\$VNBOM,N*XX Where N is 1-3 to select the appropriate binary output register.
UART Response	Responds with requested binary packet.



To use the Binary Output Poll command you will first need to configure the desired output packet using the Binary Output Register 1-3. If you wish only to poll this output, set the rate in the Binary Output Register to 0. When you wish to poll the measurement send the command \$VNBOM,N*XX where the N is the number of the appropriate binary output register.

6.2 Configuration Registers

6.2.1 User Tag Register

User Tag				
Register ID :	0			Access : Read / Write
Comment :	User assigned tag register. Any values can be assigned to this register. They will be stored to flash upon issuing a write settings command.			
Size (Bytes):	20			
Example Response:	\$VNRRG,00,SENSOR_A14*52			
Offset	Name	Format	Unit	Description
0	Tag	char	-	User defined tag register. Up to 20 bytes or characters. If a string with more than 20 characters is given, then the string will be truncated to the first 20.



Only printable ASCII characters are allowed for the user tag register.

Allowable characters include any character in the hexadecimal range of 0x20 to 0x7E, excluding 0x24 ('\$'), 0x2C (','), and 0x2A (*). The use of any other character will result in an invalid parameter error code returned. This restriction is required to ensure that the value set in the user tag register remains accessible using the serial ASCII protocol.

6.2.2 Model Number Register

Model Number				
Register ID :	1			Access : Read Only
Comment :	Model Number			
Size (Bytes):	24			
Example Response:	\$VNRRG,01,VN-310*58			
Offset	Name	Format	Unit	Description
0	Product Name	char	-	Product name. Max 24 characters.

6.2.3 Hardware Revision Register

Register ID : 2 **Access :** Read Only

Comment : Hardware revision.

Size (Bytes): 4

Example Response: \$VNRRG,02,1*6C

Offset	Name	Format	Unit	Description
0	Revision	uint32	-	Hardware revision.

6.2.4 Serial Number Register

Serial Number				
Register ID :	3			Access : Read Only
Comment :	Serial Number			
Size (Bytes):	4			
Example Response:	\$VNRRG,03,0100011981*5D			
Offset	Name	Format	Unit	Description
0	SerialNum	uint32	-	Serial Number (32-bit unsigned integer)

6.2.5 Firmware Version Register

Firmware Version Register				
Register ID :	4			Access : Read Only
Comment :	Firmware version.			
Size (Bytes):	4			
Example Response:	\$VNRRG,04,0.4.0.0*71			
Offset	Name	Format	Unit	Description
0	Major Version	uint8	-	Major release version of firmware.
1	Minor Version	uint8	-	Minor release version of firmware
2	Feature Version	uint8	-	Feature release version of the firmware.
3	HotFix	uint8	-	Hot fix number. Numbers above 100 are reserved for custom firmware versions.

6.2.6 Serial Baud Rate Register

Serial Baud Rate				
Register ID :		5	Access : Read / Write	
Comment :		Serial baud rate.		
Size (Bytes):		4		
Example Command:		\$VNWRG,05,115200*58		
Offset	Name	Format	Unit	Description
0	Baud Rate	uint32	-	Serial baud rate.
4	Serial Port	uint8	-	Optional. The serial port to change the baud rate on. If this parameter is not provided then the baud rate will be changed for the active serial port. 1 – Serial Port 1 2 – Serial Port 2

Baud Rate Settings

Acceptable Baud Rates

9600

19200

38400

57600

115200

128000

230400

460800

921600



The serial port parameter in this register is optional. If it is not provided, the baud rate will be changed on the active serial port. The response to this register will include the serial port parameter if the optional parameter is provided. If the second parameter is not provided then the response will not include this parameter.



Upon receiving a baud rate change request, the VN-300 will send the response prior to changing the baud rate.

6.2.7 Async Data Output Type Register

Asynchronous Data Output Type				
Register ID :		6	Access : Read / Write	
Comment :		Asynchronous data output type.		
Size (Bytes):		4		
Example Command:		\$VNWRG,06,0*6C		
Offset	Name	Format	Unit	Description
0	ADOR	uint32	-	Output register.
4	Serial Port	uint8	-	Optional. The serial port to change the asynchronous data type on. If this parameter is not provided then the ADOR will be changed for the active serial port. 1 – Serial Port 1 2 – Serial Port 2

This register controls the type of data that will be asynchronously outputted by the module. With this register, the user can specify which data register will be automatically outputted when it gets updated with a new reading. The table below lists which registers can be set to asynchronously output, the value to specify which register to output, and the header of the asynchronous data packet. Asynchronous data output can be disabled by setting this register to zero. The asynchronous data output will be sent out automatically at a frequency specified by the Async Data Output Frequency Register.



The serial port parameter in this register is optional. If it is not provided, the ADOF will be changed on the active serial port. The response to this register will include the serial port parameter if the optional parameter is provided. If the second parameter is not provided, the response will not include this parameter.

Asynchronous Solution Output Settings

Setting	Asynchronous Solution Output Type	Header
0	Asynchronous output turned off	N/A
1	Yaw, Pitch, Roll	VNYPR
2	Quaternion	VNQTN
8	Quaternion, Magnetic, Acceleration and Angular Rates	VNQMR
9	Directional Cosine Orientation Matrix	VNDCM
10	Magnetic Measurements	VNMAG
11	Acceleration Measurements	VNACC
12	Angular Rate Measurements	VNGYR
13	Magnetic, Acceleration, and Angular Rate Measurements	VNMAR
14	Yaw, Pitch, Roll, Magnetic, Acceleration, and Angular Rate Measurements	VNYMR
16	Yaw, Pitch, Roll, Body True Acceleration, and Angular Rates	VNYBA
17	Yaw, Pitch, Roll, Inertial True Acceleration, and Angular Rates	VNYIA
19	IMU Measurements	VNIMU
20	GNSS Solution LLA	VNGPS
21	GNSS Solution ECEF	VNGPE
22	INS LLA	VNINS
23	INS ECEF	VNINE
28	INS LLA 2	VNISL
29	INS ECEF 2	VNISE
30	Delta theta and delta velocity	VNDTV
32	GNSS2 Solution LLA	VNG2S
33	GNSS2 Solution ECEF	VNG2E

6.2.8 Async Data Output Frequency Register

Asynchronous Data Output Frequency				
Register ID :		7	Access : Read / Write	
Comment :		Asynchronous data output frequency.		
Size (Bytes):		4		
Example Command:		\$VNWRG,07,40*59		
Offset	Name	Format	Unit	Description
0	ADOF	uint32	Hz	Output frequency.
4	Serial Port	uint8	-	Optional. The serial port to change the asynchronous data type frequency on. If this parameter is not provided then the ADOF will be changed for the active serial port. 1 – Serial Port 1 2 – Serial Port 2

ADOR Data Rates

Acceptable Data Rates (Hz)
1
2
4
5
10
20
25
40
50
100
200



The serial port parameter in this register is optional. If it is not provided, the ADOF will be changed on the active serial port. The response to this register will include the serial port parameter if the optional parameter is provided. If the second parameter is not provided, the response will not include this parameter.

6.2.9 Synchronization Control

Synchronization Control				
Register ID :	32	Access :	Read / Write	
Comment :	Contains parameters which allow the timing of the VN-300 to be synchronized with external devices.			
Size (Bytes):	20			
Example Response:	\$VNRRG,32,3,0,0,0,6,1,0,10000000,0*6B			
Offset	Name	Format	Unit	Description
0	SyncInMode	uint8	-	Input signal synchronization mode
1	SyncInEdge	uint8	-	Input signal synchronization edge selection
2	SyncInSkipFactor	uint16	-	Input signal trigger skip factor
4	RESERVED	uint32	-	Reserved for future use. Defaults to 0.
8	SyncOutMode	uint8	-	Output synchronization signal mode
9	SyncOutPolarity	uint8	-	Output synchronization signal polarity
10	SyncOutSkipFactor	uint16	-	Output synchronization signal skip factor
12	SyncOutPulseWidth	uint32	ns	Output synchronization signal pulse width
16	RESERVED	uint32	-	Reserved for future use. Defaults to 0.

SyncInMode

The SyncInMode register controls the behavior of the SyncIn event. If the mode is set to COUNT then the internal clock will be used to control the IMU sampling. If SyncInMode is set to IMU then the IMU sampling loop will run on a SyncIn event. The relationship between the SyncIn event and a SyncIn trigger is defined by the SyncInEdge and SyncInSkipFactor parameters. If set to ASYNC then the VN-300 will output asynchronous serial messages upon each trigger event.

SyncIn Mode

Mode	Pin	Value	Description
COUNT	SYNC_IN	3	Count number of trigger events on SYNC_IN.
IMU	SYNC_IN	4	Start IMU sampling on trigger of SYNC_IN.
ASYNC	SYNC_IN	5	Output asynchronous message on trigger of SYNC_IN.
ASYNC3	SYNC_IN	6	Output asynchronous or binary messages configured with a rate of 0 to output on trigger of SYNC_IN.



In ASYNC3 mode messages configured with an output rate = 0 are output each time the appropriate transition edge of the SyncIn pin is captured according to the edge settings in the SyncInEdge field. Messages configured with output rate > 0 are not affected by the SyncIn pulse. This applies to the ASCII Async message set by the Async Data Output Register, the user configured binary output messages set by the Binary Output Registers, as well as the NMEA messages configured by the NMEA Output Registers.

SyncInEdge

The SyncInEdge register controls the type of edge the signal is set to trigger on. The factory default state is to trigger on a rising edge.

SyncInEdge Mode

Value	Description
0	Trigger on rising edge
1	Trigger on falling edge

SyncInSkipFactor

The SyncInSkipFactor defines how many times trigger edges defined by SyncInEdge should occur prior to triggering a SyncIn event. The action performed on a SyncIn event is determined by the SyncIn mode. As an example if the SyncInSkipFactor was set to 4 and a 1 kHz signal was attached to the SyncIn pin, then the SyncIn event would only occur at 200 Hz.

SyncOutMode

The SyncOutMode register controls the behavior of the SyncOut pin. If this is set to IMU then the SyncOut will start the pulse when the internal IMU sample loop starts. This mode is used to make a sensor the Master in a multi-sensor network array. If this is set to IMU_READY mode then the pulse will start when IMU measurements become available. If this is set to INS mode then the pulse will start when attitude measurements are made available. Changes to this register take effect immediately.

SyncOutMode

Mode	Value	Description
NONE	0	None
IMU_START	1	Trigger at start of IMU sampling
IMU_READY	2	Trigger when IMU measurements are available
INS	3	Trigger when attitude measurements are available
GPS_PPS	6	Trigger on a GPS PPS event (1 Hz) when a 3D fix is valid.

SyncOutPolarity

The SyncOutPolarity register controls the polarity of the output pulse on the SyncOut pin. Changes to this register take effect immediately.

SyncOutPolarity

Value	Description
0	Negative Pulse
1	Positive Pulse

SyncOutSkipFactor

The SyncOutSkipFactor defines how many times the sync out event should be skipped before actually triggering the SyncOut pin.

SyncOutPulseWidth

The SyncOutPulseWidth field controls the desired width of the SyncOut pulse. The default value is 100,000,000 (100 ms).

6.2.10 Communication Protocol Control

Communication Protocol Control				
Register ID :	30			Access : Read / Write
Comment :	Contains parameters that controls the communication protocol used by the sensor.			
Size (Bytes):	7			
Example Response:	\$VNRRG,30,0,0,0,0,1,0,1*6C			
Offset	Name	Format	Unit	Description
0	SerialCount	uint8	-	Provides the ability to append a counter or time to the end of the serial asynchronous messages.
1	SerialStatus	uint8	-	Provides the ability to append the status to the end of the serial asynchronous messages.
2	SPICount	uint8	-	Provides the ability to append a counter to the end of the SPI packets.
3	SPIStatus	uint8	-	Provides the ability to append the status to the end of the SPI packets.
4	SerialChecksum	uint8	-	Choose the type of checksum used for serial communications.
5	SPIChecksum	uint8	-	Choose the type of checksum used for the SPI communications.
6	ErrorMode	uint8	-	Choose the action taken when errors are generated.

Serial Count

The SerialCount field provides a means of appending a time or counter to the end of all asynchronous communication messages transmitted on the serial interface. The values for each of these counters come directly from the Synchronization Status Register in the System subsystem.

With the SerialCount field set to OFF a typical serial asynchronous message would appear as the following:

```
$VNYPR,+010.071,+000.278,-002.026*60
```

With the SerialCount field set to one of the non-zero values the same asynchronous message would appear instead as:

```
$VNYPR,+010.071,+000.278,-002.026,T1162704*2F
```

When the SerialCount field is enabled the counter will always be appended to the end of the message just prior to the checksum. The counter will be preceded by the T character to distinguish it from the status field.

SerialCount Field

Mode	Value	Description
NONE	0	OFF
SYNCIN_COUNT	1	SyncIn Counter
SYNCIN_TIME	2	SyncIn Time
SYNCOUT_COUNT	3	SyncOut Counter
GPS_PPS	4	Gps Pps Time

SerialStatus

The SerialStatus field provides a means of tracking real-time status information pertain to the overall state of the sensor measurements and onboard filtering algorithm. As with the SerialCount, a typical serial asynchronous message would appear as the following:

```
$VNYPR,+010.071,+000.278,-002.026*60
```

With the SerialStatus field set to one of the non-zero values, the same asynchronous message would appear instead as:

```
$VNYPR,+010.071,+000.278,-002.026,S0000*1F
```

When the SerialStatus field is enabled the status will always be appended to the end of the message just prior to the checksum. If both the SerialCount and SerialStatus are enabled then the SerialStatus will be displayed first. The counter will be preceded by the S character to distinguish it from the counter field. The status consists of 4 hexadecimal characters.

SerialStatus

Value	Description
0	OFF
1	VPE Status
2	INS Status

SPICount

The SPICount field provides a means of appending a time or counter to the end of all SPI packets. The values for each of these counters come directly from the Synchronization Status Register.

SPICount Field

Mode	Value	Description
NONE	0	OFF
SYNCIN_COUNT	1	SyncIn Counter
SYNCIN_TIME	2	SyncIn Time
SYNCOUT_COUNT	3	SyncOut Counter
GPS_PPS	4	Gps Pps Time

SPIStatus

The AsyncStatus field provides a means of tracking real-time status information pertaining to the overall state of the sensor measurements and onboard filtering algorithm. This information is very useful in situations where action must be taken when certain crucial events happen such as the detection of gyro saturation or magnetic interference.

SPIStatus

Value	Description
0	OFF
1	VPE Status
2	INS Status

SerialChecksum

This field controls the type of checksum used for the serial communications. Normally the VN-300 uses an 8-bit checksum identical to the type used for normal GNSS NMEA packets. This form of checksum however offers only a limited means of error checking. As an alternative a full 16-bit CRC (CRC16-CCITT with polynomial = 0x07) is also offered. The 2-byte CRC value is printed using 4 hexadecimal digits.

SerialChecksum

Value	Description
1	8-Bit Checksum
3	16-Bit CRC

SPIChecksum

This field controls the type of checksum used for the SPI communications. The checksum is appended to the end of the binary data packet. The 16-bit CRC is identical to the one described above for the SerialChecksum.

SPIChecksum

Value	Description
0	OFF
1	8-Bit Checksum
3	16-Bit CRC

ErrorMode

This field controls the type of action taken by the VN-300 when an error event occurs. If the send error mode is enabled then a message similar to the one shown below will be sent on the serial bus when an error event occurs.

```
$VNERR,03*72
```

Regardless of the state of the ErrorMode, the number of error events is always recorded and is made available in the SysErrors field of the Communication Protocol Status Register in the System subsystem.

ErrorMode

Value	Description
0	Ignore Error
1	Send Error
2	Send Error and set ADOR register to OFF

Example Async Messages

The following table shows example asynchronous messages with the AsyncCount and the AsyncStatus values appended to the end.

Example Type	Message
Async Message with AsyncCount Enabled	\$VNYPR,+010.071,+000.278,-002.026,T1162704*2F
Async Message with AsyncStatus Enabled	\$VNYPR,+010.071,+000.278,-002.026,S0000*1F
Async Message with AsyncCount and AsyncStatus Enabled	\$VNYPR,+010.071,+000.278,-002.026,T1162704,S0000*50

6.2.11 Binary Output Register 1

Binary Output Register 1

Register ID : 75

Access : Read / Write

Comment : This register allows the user to construct a custom binary output message that contains a collection of desired estimated states and sensor measurements.

Size (Bytes): 6-22

Example Response: \$VNWRG,75,2,4,1,8*XX

Offset	Name	Format	Unit	Description
0	AsyncMode	uint16	-	Selects whether the output message should be sent out on the serial port(s) at a fixed rate. 0 = None. User message is not automatically sent out either serial port. 1 = Message is sent out serial port 1 at a fixed rate. 2 = Message is sent out serial port 2 at a fixed rate. 3 = Message is sent out both serial ports at a fixed rate.
2	RateDivisor	uint16	-	Sets the fixed rate at which the message is sent out the selected serial port(s). The number given is a divisor of the ImuRate which is nominally 400 Hz. For example to have the sensor output at 50Hz you would set the Divisor equal to 8.
4	OutputGroup	uint16	-	Selects which output groups are active in the message. The number of OutputFields in this message should equal the number of active bits in the OutputGroup .
4+N	OutputGroup(N)	uint8	-	Selects which output groups are active in the message. The number of OutputFields in this message should equal the number of active bits in the OutputGroup .
4+N+2*M	OutputField(1)	uint16	-	Selects which output data fields are active within the selected output groups.



See the User Configurable Binary Output Messages section for information on the format for the Groups and Group Fields.

In the offset column above the variable N is the number of output group bytes. If data is requested from only groups 1-7, there will be only one output group present (N=1). If data is requested from an output group of 9-14, then two output groups bytes will be present.

The number of OutputFields present must be equal to the number of output groups selected in the OutputGroup byte(s). For example if groups 1 and 3 are selected (OutputGroup = 0x05 or 0b00000101), then there must be two OutputField parameters present (M = 2).



If the number of OutputFields is inconsistent with the number of OutputGroups selected, then the unit will respond with an invalid parameter error when attempting to write to this register.

If the user attempts to turn on more data than it is possible to send out at the current baud rate, the unit will respond with an insufficient baud rate error.



To turn off the binary output it is recommended to set the AsyncMode = 0.

6.2.12 Binary Output Register 2

Binary Output Register 2

Register ID : 76

Access : Read / Write

Comment : This register allows the user to construct a custom binary output message that contains a collection of desired estimated states and sensor measurements.

Size (Bytes): 6-22

Example Response: \$VNWRG,76,2,4,1,8*XX

Offset	Name	Format	Unit	Description
0	AsyncMode	uint16	-	Selects whether the output message should be sent out on the serial port(s) at a fixed rate. 0 = None. User message is not automatically sent out either serial port. 1 = Message is sent out serial port 1 at a fixed rate. 2 = Message is sent out serial port 2 at a fixed rate. 3 = Message is sent out both serial ports at a fixed rate.
2	RateDivisor	uint16	-	Sets the fixed rate at which the message is sent out the selected serial port(s). The number given is a divisor of the ImuRate which is nominally 400 Hz. For example to have the sensor output at 50Hz you would set the Divisor equal to 8.
4	OutputGroup	uint16	-	Selects which output groups are active in the message. The number of OutputFields in this message should equal the number of active bits in the OutputGroup .
4+N	OutputGroup(N)	uint8	-	Selects which output groups are active in the message. The number of OutputFields in this message should equal the number of active bits in the OutputGroup .
4+N+2*M	OutputField(1)	uint16	-	Selects which output data fields are active within the selected output groups.



See the User Configurable Binary Output Messages section for information on the format for the Groups and Group Fields.

In the offset column above the variable N is the number of output group bytes. If data is requested from only groups 1-7, there will be only one output group present (N=1). If data is requested from an output group of 9-14, then two output groups bytes will be present.

The number of OutputFields present must be equal to the number of output groups selected in the OutputGroup byte(s). For example if groups 1 and 3 are selected (OutputGroup = 0x05 or 0b00000101), then there must be two OutputField parameters present (M = 2).



If the number of OutputFields is inconsistent with the number of OutputGroups selected, then the unit will respond with an invalid parameter error when attempting to write to this register.

If the user attempts to turn on more data than it is possible to send out at the current baud rate, the unit will respond with an insufficient baud rate error.



To turn off the binary output it is recommended to set the AsyncMode = 0.

6.2.13 Binary Output Register 3

Binary Output Register 3

Register ID : 77

Access : Read / Write

Comment : This register allows the user to construct a custom binary output message that contains a collection of desired estimated states and sensor measurements.

Size (Bytes): 6-22

Example Response: \$VNWRG,77,2,4,1,8*XX

Offset	Name	Format	Unit	Description
0	AsyncMode	uint16	-	Selects whether the output message should be sent out on the serial port(s) at a fixed rate. 0 = None. User message is not automatically sent out either serial port. 1 = Message is sent out serial port 1 at a fixed rate. 2 = Message is sent out serial port 2 at a fixed rate. 3 = Message is sent out both serial ports at a fixed rate.
2	RateDivisor	uint16	-	Sets the fixed rate at which the message is sent out the selected serial port(s). The number given is a divisor of the ImuRate which is nominally 400 Hz. For example to have the sensor output at 50Hz you would set the Divisor equal to 8.
4	OutputGroup	uint16	-	Selects which output groups are active in the message. The number of OutputFields in this message should equal the number of active bits in the OutputGroup .
4+N	OutputGroup(N)	uint8	-	Selects which output groups are active in the message. The number of OutputFields in this message should equal the number of active bits in the OutputGroup .
4+N+2*M	OutputField(1)	uint16	-	Selects which output data fields are active within the selected output groups.



See the User Configurable Binary Output Messages section for information on the format for the Groups and Group Fields.

In the offset column above the variable N is the number of output group bytes. If data is requested from only groups 1-7, there will be only one output group present (N=1). If data is requested from an output group of 9-14, then two output groups bytes will be present.

The number of OutputFields present must be equal to the number of output groups selected in the OutputGroup byte(s). For example if groups 1 and 3 are selected (OutputGroup = 0x05 or 0b00000101), then there must be two OutputField parameters present (M = 2).



If the number of OutputFields is inconsistent with the number of OutputGroups selected, then the unit will respond with an invalid parameter error when attempting to write to this register.

If the user attempts to turn on more data than it is possible to send out at the current baud rate, the unit will respond with an insufficient baud rate error.



To turn off the binary output it is recommended to set the AsyncMode = 0.

6.2.14 NMEA Output Register 1

NMEA Output Register 1				
Register ID :	101			Access : Read / Write
Comment :	This register allows the user to select a set of NMEA messages to output to the configured serial port.			
Size (Bytes):	8			
Example Response:	\$VNWRG,101,1,5,0,0,1FF*XX			
Offset	Name	Format	Unit	Description
0	Port	uint8	-	Selects whether the set of output messages should be sent out on the serial port(s) at a fixed rate. 0 = None. NMEA messages are not automatically sent out either serial port. 1 = Messages are sent out serial port 1 at a fixed rate. 2 = Messages are sent out serial port 2 at a fixed rate. 3 = Messages are sent out both serial ports at a fixed rate.
1	Rate	uint8	-	Sets the fixed rate at which the message is sent out the selected serial port(s). The number given is the output rate in Hz of the set of NMEA messages. Messages derived from GNSS data can be configured for 1 or 5Hz. Messages derived from INS solution can be configured for 1, 5, 10 or 20 Hz.
2	Mode	uint8	-	Reserved. Must be zero.
3	Reserved	uint8	-	Reserved. Must be zero.
4	Message selection	uint32	-	Bitfield to select individual message types. User should input this value in hexadecimal format.

NMEA message selection

Name	Data Source	Bit Offset	Description
RMC	GNSS	0	Recommended Minimum Sentence (GNSS)
RMC	INS	1	Recommended Minimum Sentence (INS)
GGA	GNSS	2	GNSS fix data and undulation (GNSS)
GGA	INS	3	GNSS fix data and undulation (INS)
GLL	GNSS	4	Geographic Position (GNSS)
GLL	INS	5	Geographic Position (INS)
GSA	GNSS	6	GNSS DOP and active satellites
GSV	GNSS	7	GNSS satellites in view
HDG	INS	8	Heading
HDT	INS	9	Heading, true
THS	INS	10	True heading and status
VTG	GNSS	11	Course over ground and ground speed (GNSS)
VTG	INS	12	Course over ground and ground speed (INS)
ZDA	GNSS	13	UTC time and date (GNSS)
ZDA	INS	14	UTC time and date (INS)
PASHR	INS	15	Inertial attitude data
TSS1	INS	16	
Reserved		17-31	Reserved for future use. Should be set to zero.

6.2.15 NMEA Output Register 2

NMEA Output Register 2				
Register ID :	102			Access : Read / Write
Comment :	This register allows the user to select a set of NMEA messages to output to the configured serial port.			
Size (Bytes):	8			
Example Response:	\$VNWRG,102,1,5,0,0,1FF*XX			
Offset	Name	Format	Unit	Description
0	Port	uint8	-	Selects whether the set of output messages should be sent out on the serial port(s) at a fixed rate. 0 = None. NMEA messages are not automatically sent out either serial port. 1 = Messages are sent out serial port 1 at a fixed rate. 2 = Messages are sent out serial port 2 at a fixed rate. 3 = Messages are sent out both serial ports at a fixed rate.
1	Rate	uint8	-	Sets the fixed rate at which the message is sent out the selected serial port(s). The number given is the output rate in Hz of the set of NMEA messages. Messages derived from GNSS data can be configured for 1 or 5Hz. Messages derived from INS solution can be configured for 1, 5, 10 or 20 Hz.
2	Mode	uint8	-	Reserved. Must be zero.
3	Reserved	uint8	-	Reserved. Must be zero.
4	Message selection	uint32	-	Bitfield to select individual message types. User should input this value in hexadecimal format.

NMEA message selection

Name	Data Source	Bit Offset	Description
RMC	GNSS	0	Recommended Minimum Sentence (GNSS)
RMC	INS	1	Recommended Minimum Sentence (INS)
GGA	GNSS	2	GNSS fix data and undulation (GNSS)
GGA	INS	3	GNSS fix data and undulation (INS)
GLL	GNSS	4	Geographic Position (GNSS)
GLL	INS	5	Geographic Position (INS)
GSA	GNSS	6	GNSS DOP and active satellites
GSV	GNSS	7	GNSS satellites in view
HDG	INS	8	Heading
HDT	INS	9	Heading, true
THS	INS	10	True heading and status
VTG	GNSS	11	Course over ground and ground speed (GNSS)
VTG	INS	12	Course over ground and ground speed (INS)
ZDA	GNSS	13	UTC time and date (GNSS)
ZDA	INS	14	UTC time and date (INS)
PASHR	INS	15	Inertial attitude data
TSS1	INS	16	
Reserved		17-31	Reserved for future use. Should be set to zero.

6.3 Status Registers

6.3.1 Synchronization Status

Synchronization Status				
Register ID :	33			Access : Read / Write
Comment :	Contains status parameters that pertaining to the communication synchronization features.			
Size (Bytes):	12			
Example Response:	\$VNRRG,33,2552498,0,0*6A			
Offset	Name	Format	Unit	Description
0	SyncInCount	uint32	-	Keeps track of the number of times that the SyncIn trigger even has ocured. This register can be used to correlate the attitude to an event on an external system such as a camera or GNSS. It is also possible to have the value of this register appended to each asynchronous data packet on the serial bus. This can be done by setting the AsyncStatus field in the Communication Protocol register to 1.
4	SyncInTime	uint32	µs	Keeps track of the amount of time that has elapsed since the last SyncIn trigger event. If the SyncIn pin is connected to the PPS (Pulse Per Second) line on a GNSS and the AsyncStatus field in the Communication Protocol Register is set to 1, then each asynchronous measurement will be time stamped relative to the last received GNSS measurement.
8	SyncOutCount	uint32	-	Keeps track of the number of times that the SyncOut trigger event has occurred. This register can be used to index subsequent measurement outputs, which is particularly useful when logging sensor data.



Writing zero to the SyncInCount or the SyncOutCount will reset the status counter. Any other value other than zero will not have an effect. The SyncInTime is read only and cannot be reset to zero.

6.4 Factory Defaults

Settings Name	Default Factory Value
User Tag	NULL (Empty string)
Serial Baud Rate	115200
Async Data Output Frequency	40 Hz
Async Data Output Type	INS_LLA
Synchronization Control	3,0,0,0,6,1,0,100000000,0
Communication Protocol Control	0,0,0,0,1,0,1
Binary Output Register 1	0, 0, 0
Binary Output Register 2	0, 0, 0
Binary Output Register 3	0, 0, 0
NMEA Output Register 1	0,0,0,0,0
NMEA Output Register 2	0,0,0,0,0

6.5 Command Prompt

The command prompt provides a fast and simple means of configuring and monitoring the status of the sensor by typing commands to the unit using the serial port.

6.5.1 List Available Commands

Commands for the System subsystem can be accessed by typing in 'system' at the command prompt. To view all available commands, type 'system ?'. Below is a view of a terminal window showing a list of the available commands.

```
system ?  
  
System Module Commands:  
  
Command:      Description:  
-----  
info          Device specific information such as serial number and firmware version.  
comm          Information on the communication interfaces.  
errors        Overview of the logged system errors.  
reset         Perform a software reset on the unit.  
save          Save register settings to flash memory.  
restore       Restore register settings to their factory default state.
```

6.5.2 System Info

```
system info  
  
----- System Info -----  
  
Hardware:  
  Product Model:  VN-310  
  Serial Number:  100013003  
  MCU Serial Number: 34323439044731322F002100  
  Hardware Revision: 2  
  Form Revision:  1  
  
Software:  
  Firmware Version: 0.3.0.0  
  Revision:         691  
  Build Number:    2813  
  
-----
```

6.5.3 System Comm

```
system comm  
  
----- System Communication Interfaces -----  
  
Communication Stats:  
  Serial Messages Parsed           : 29  
  Spi Messages Parsed              : 0  
  Max Serial RX Buffer Usage        : 0  
  Max Serial TX Buffer Usage        : 4  
  Max Spi RX Buffer Usage           : 0  
  Max Spi TX Buffer Usage           : 0
```

```
Current Serial 1 TX Bandwidth Usage : 00.0
Current Serial 2 TX Bandwidth Usage : 49.3
```

```
Max Serial 1 TX Bandwidth Usage : 49.3
Max Serial 2 TX Bandwidth Usage : 50.5
```

```
Min Serial 1 TX Bandwidth Usage : 00.0
Min Serial 2 TX Bandwidth Usage : 48.1
```

6.5.4 System Errors

```
system errors
```

```
----- System Errors -----
```

```
Hard Fault Exceptions           : 0
Serial Input Buffer Overflow     : 0
Serial Output Buffer Overflow    : 0
Serial Insufficient Bandwidth   : 0
Invalid Checksums               : 6
Invalid Commands                : 2
Input Error - Too Few Parameters : 0
Input Error - Too Many Parameters : 0
Input Error - Invalid Parameter  : 0
Input Error - Invalid Register   : 0
Input Error - Unauthorized Access : 2
Input Error - Watchdog Reset     : 0
```

6.5.5 System Reset

```
system reset
```

6.5.6 System Save

```
system save
```

7 IMU Subsystem

7.1 IMU Measurement Registers

7.1.1 IMU Measurements

This register provides direct access to the calibrated magnetometer, accelerometer, gyro, barometric pressure, and temperature measurements available from the onboard IMU.

IMU Measurements				
Register ID :	54	Async Header :	IMU	Access : Read Only
Comment :	Provides the calibrated IMU measurements including barometric pressure.			
Size (Bytes):	44			
Example Read Response:	\$VNRRG,54,-02.0841,+00.6045,+02.8911,+00.381,-00.154,-09.657,-00.005683,+00.000262,+00.001475,+21.6,+00099.761*5B			
Offset	Name	Format	Unit	Description
0	MagX	float	Gauss	Uncompensated Magnetic X-axis.
4	MagY	float	Gauss	Uncompensated Magnetic Y-axis.
8	MagZ	float	Gauss	Uncompensated Magnetic Z-axis.
12	AccelX	float	m/s ²	Uncompensated Acceleration X-axis.
16	AccelY	float	m/s ²	Uncompensated Acceleration Y-axis.
20	AccelZ	float	m/s ²	Uncompensated Acceleration Z-axis.
24	GyroX	float	rad/s	Uncompensated Angular rate X-axis.
28	GyroY	float	rad/s	Uncompensated Angular rate Y-axis.
32	GyroZ	float	rad/s	Uncompensated Angular rate Z-axis.
36	Temp	float	C	IMU Temperature.
40	Pressure	float	kPa	Barometric pressure.



You can configure the device to output this register at a fixed rate using the Async Data Output Type Register in the System subsystem. Once configured the data in this register will be sent out with the \$VNIMU header.

7.1.2 Delta Theta and Delta Velocity

Delta Theta and Delta Velocity				
Register ID :	80	Async Header:	DTV	Access : Read
Comment :	This register contains the output values of the onboard coning and sculling algorithm.			
Size (Bytes):	28			
Example Response:	\$VNRRG,80,+0.665016,-000.119,-000.409,-000.025,+000.011,-000.084,-006.702*6A			
Offset	Name	Format	Unit	Description
0	DeltaTime	float	sec	Delta time for the integration interval
4	DeltaThetaX	float	deg	Delta rotation vector component in the x-axis.
8	DeltaThetaY	float	deg	Delta rotation vector component in the y-axis.
12	DeltaThetaZ	float	deg	Delta rotation vector component in the z-axis.
16	DeltaVelocityX	float	m/s	Delta velocity vector component in the x-axis.
20	DeltaVelocityY	float	m/s	Delta velocity vector component in the y-axis.
24	DeltaVelocityZ	float	m/s	Delta velocity vector component in the z-axis.

The Delta Theta and Delta Velocity register contains the computed outputs from the onboard coning and sculling algorithm. The coning and sculling integrations are performed at the IMU sample rate (nominally at 400Hz) and reset when the register data is output. If polling this register, the values will represent the delta time, angles, and velocity since the register was last polled. If the Delta Theta/Velocity data is selected for asynchronous output via the Async Data Output Type register (Register 6, type 30), the integrals will be reset each time the data is asynchronously output at the configured rate.

The delta time output contains the length of the time interval over which the deltas were calculated. This can be used to check the interval time or to compute nonlinear “average” rates and accelerations from the integrated values.

The delta theta is output as a principal rotation vector, defined as the product of the unit vector of the principal rotation axis and the principal rotation angle in degrees. For small rotations, a typical use case for delta angles, the principal rotation vector elements may be treated individually as rotations in degrees about the individual sensor axes (in any Euler rotation sequence) with little error.

The delta velocity output provides the integration of the acceleration in the chosen frame, taking into account the coupling effects of any simultaneous rotation experienced.

The coning and sculling algorithm can be configured to operate in multiple frames and with a variety of compensations applied. See the Delta Theta and Delta Velocity Configuration Register in the IMU subsystem for further details.



You can configure the device to output this register at a fixed rate using the Async Data Output Type Register in the System subsystem. Once configured the data in this register will be sent out with the \$VNDTV header.

7.2 IMU Configuration Registers

7.2.1 Magnetometer Compensation

Magnetometer Compensation				
Register ID :	23			Access: Read / Write
Comment :	Allows the magnetometer to be compensated for hard/soft iron effects.			
Size (Bytes):	48			
Example Command:	\$VNRRG,23,1,0,0,0,1,0,0,0,1,0,0,0*73			
Offset	Name	Format	Unit	Description
0	C[0,0]	float	-	
4	C[0,1]	float	-	
8	C[0,2]	float	-	
12	C[1,0]	float	-	
16	C[1,1]	float	-	
20	C[1,2]	float	-	
24	C[2,0]	float	-	
28	C[2,1]	float	-	
32	C[2,2]	float	-	
36	B[0]	float	Gauss	
40	B[1]	float	Gauss	
44	B[2]	float	Gauss	

This register contains twelve values representing the hard and soft iron compensation parameters. The magnetic measurements are compensated for both hard and soft iron using the following model. Under normal circumstances this register can be left in its factory default state. In the event that there are disturbances in the magnetic field due to hard or soft iron effects, then these registers allow for further compensation. These registers can also be used to compensate for significant changes to the magnetometer bias, gain, and axis alignment during installation. Note that this magnetometer compensation is separate from the compensation that occurs during the calibration process at the factory. Setting this register to the default state of an identity matrix and zero offset will not eliminate the magnetometer gain, bias, and axis alignment that occur during factory calibration. These registers only need to be changed from their default values in the event that hard/soft iron compensation needs to be performed, or changes in bias, gain, and axis alignment have occurred at some point between the times the chip was calibrated at the factory and when it is used in the field.

$$\begin{Bmatrix} X \\ Y \\ Z \end{Bmatrix} = \begin{bmatrix} C00 & C01 & C02 \\ C10 & C11 & C12 \\ C20 & C21 & C22 \end{bmatrix} \cdot \begin{Bmatrix} MX - B0 \\ MY - B1 \\ MZ - B2 \end{Bmatrix}$$

The variables $\{MX, MY, MZ\}$ are components of the measured magnetic field. The $\{X, Y, Z\}$ variables are the new magnetic field measurements outputted after compensation for hard/soft iron effects. All twelve numbers are represented by single-precision floating points.

7.2.2 Acceleration Compensation

Accelerometer Compensation				
Register ID :	25			Access : Read / Write
Comment :	Allows the accelerometer to be further compensated for scale factor, misalignment, and bias errors.			
Size (Bytes):	48			
Example Command:	\$VNRRG,25,1,0,0,0,1,0,0,0,1,0,0,0*75			
Offset	Name	Format	Unit	Description
0	C[0,0]	float	-	
4	C[0,1]	float	-	
8	C[0,2]	float	-	
12	C[1,0]	float	-	
16	C[1,1]	float	-	
20	C[1,2]	float	-	
24	C[2,0]	float	-	
28	C[2,1]	float	-	
32	C[2,2]	float	-	
36	B[0]	float	m/s ²	
40	B[1]	float	m/s ²	
44	B[2]	float	m/s ²	

This register contains twelve values representing the accelerometer compensation parameters. The accelerometer measurements are compensated for changes in bias, gain, and axis alignment that can occur during the installation of the chip on the customer's board using the following model. Under normal circumstances this register can be left in its factory default state. In the event that there are significant changes to the accelerometer bias, gain, and axis alignment during installation, then these registers allow for further compensation. Note that this accelerometer compensation is separate from the compensation that occurs during the calibration process at the factory. Setting this register to the default state of an identity matrix and zero offset will not eliminate the accelerometer gain, bias, and axis alignment that occur during factory calibration. These registers only need to be changed from their default values in the event that changes in bias, gain, and axis alignment have occurred at some point between the times the chip was calibrated at the factory and when it is used in the field.

$$\begin{Bmatrix} X \\ Y \\ Z \end{Bmatrix} = \begin{bmatrix} C00 & C01 & C02 \\ C10 & C11 & C12 \\ C20 & C21 & C22 \end{bmatrix} \cdot \begin{Bmatrix} AX - B0 \\ AY - B1 \\ AZ - B2 \end{Bmatrix}$$

The variables {AX,AY,AZ} are components of the measured acceleration. The {X, Y, Z} variables are the new acceleration measurements outputted after compensation for changes during sensor mounting. All twelve numbers are represented by single-precision floating points.

7.2.3 Gyro Compensation

Gyro Compensation				
Register ID :	84			Access : Read / Write
Comment :	Allows the gyro to be further compensated for scale factor, misalignment, and bias errors.			
Size (Bytes):	48			
Example Command:	\$VNRRG,84,1,0,0,0,1,0,0,0,1,0,0,0*7E			
Offset	Name	Format	Unit	Description
0	C[0,0]	float	-	
4	C[0,1]	float	-	
8	C[0,2]	float	-	
12	C[1,0]	float	-	
16	C[1,1]	float	-	
20	C[1,2]	float	-	
24	C[2,0]	float	-	
28	C[2,1]	float	-	
32	C[2,2]	float	-	
36	B[0]	float	rad/s	
40	B[1]	float	rad/s	
44	B[2]	float	rad/s	

This register contains twelve values representing the gyro compensation parameters. The gyro measurements are compensated for changes in bias, gain, and axis alignment that can occur during the installation of the chip on the customer's board using the following model. Under normal circumstances this register can be left in its factory default state. In the event that there are significant changes to the gyro bias, gain, and axis alignment during installation or during the life of the part; these registers allow for further compensation. Note that this gyro compensation is separate from the compensation that occurs during the calibration process at the factory. Setting this register to the default state of an identity matrix and zero offset will not eliminate the gyro gain, bias, and axis alignment that occur during factory calibration. These registers only need to be changed from their default values in the event that changes in bias, gain, and axis alignment have occurred at some point between the times the chip was calibrated at the factory and when it is used in the field.

$$\begin{Bmatrix} X \\ Y \\ Z \end{Bmatrix} = \begin{bmatrix} C00 & C01 & C02 \\ C10 & C11 & C12 \\ C20 & C21 & C22 \end{bmatrix} \cdot \begin{Bmatrix} GX - B0 \\ GY - B1 \\ GZ - B2 \end{Bmatrix}$$

The variables {GX, GY, GZ} are components of the measured angular rate. The {X, Y, Z} variables are the new angular rate measurements outputted after compensation for changes during sensor mounting. All twelve numbers are represented by single-precision floating points.

7.2.4 Reference Frame Rotation

Reference Frame Rotation				
Register ID :	26			Access : Read / Write
Comment :	Allows the measurements of the VN-300 to be rotated into a different reference frame.			
Size (Bytes):	36			
Example Response:	\$VNRRG,26,1,0,0,0,1,0,0,0,1*6A			
Offset	Name	Format	Unit	Description
0	C[0,0]	float	-	
4	C[0,1]	float	-	
8	C[0,2]	float	-	
12	C[1,0]	float	-	
16	C[1,1]	float	-	
20	C[1,2]	float	-	
24	C[2,0]	float	-	
28	C[2,1]	float	-	
32	C[2,2]	float	-	

This register contains a transformation matrix that allows for the transformation of measured acceleration, magnetic, and angular rates from the body frame of the VN-300 to any other arbitrary frame of reference. The use of this register allows for the sensor to be placed in any arbitrary orientation with respect to the user's desired body coordinate frame. This register can also be used to correct for any orientation errors due to mounting the VN-300 on the user's vehicle or platform.

$$\begin{Bmatrix} X \\ Y \\ Z \end{Bmatrix}_U = \begin{bmatrix} C00 & C01 & C02 \\ C10 & C11 & C12 \\ C20 & C21 & C22 \end{bmatrix} \cdot \begin{Bmatrix} X \\ Y \\ Z \end{Bmatrix}_B$$

The variables $\{X, Y, Z\}_B$ are a measured parameter such as acceleration in the body reference frame with respect to the VN-300. The variables $\{X, Y, Z\}_U$ are a measured parameter such as acceleration in the user's frame of reference. The reference frame rotation register thus needs to be loaded with the transformation matrix that will transform measurements from the body reference frame of the VN-300 to the desired user frame of reference.



The reference frame rotation is performed on all vector measurements prior to entering the INS filter. As such, changing this register while the attitude filter is running will lead to unexpected behavior in the INS output. To prevent this, the register is cached on startup and changes will not take effect during runtime. After setting the reference frame rotation register to its new value, send a write settings command and then reset the VN-300. This will allow the INS filter to startup with the newly set reference frame rotation.



The matrix C in the Reference Frame Rotation Register must be an orthonormal, right-handed matrix. The sensor will output an error if the tolerance is not within 1e-5. The sensor will also report an error if any of the parameters are greater than 1 or less than -1.

7.2.5 IMU Filtering Configuration

IMU Filtering Configuration				
Register ID :	85			Access : Read / Write
Comment :	Controls the level of filtering performed on the raw IMU measurements.			
Size (Bytes):	15			
Example Response:	\$VNRRG,85,0,5,5,5,0,0,3,3,3,0*78			
Offset	Name	Format	Unit	Description
0	MagWindowSize	uint16	-	Number of previous measurements averaged for magnetic measurements.
2	AccelWindowSize	uint16	-	Number of previous measurements averaged for acceleration measurements.
4	GyroWindowSize	uint16	-	Number of previous measurements averaged for gyro measurements.
6	TempWindowSize	uint16	-	Number of previous measurements averaged for temperature measurements.
8	PresWindowSize	uint16	-	Number of previous measurements averaged for pressure measurements.
10	MagFilterMode	uint8	-	Filtering mode for magnetic measurements. See table below for options.
11	AccelFilterMode	uint8	-	Filtering mode for acceleration measurements. See table below for options.
12	GyroFilterMode	uint8	-	Filtering mode for gyro measurements. See table below for options.
13	TempFilterMode	uint8	-	Filtering mode for temperature measurements. See table below for options.
14	PresFilterMode	uint8	-	Filtering mode for pressure measurements. See table below for options.

This register allows the user to configure the FIR filtering what is applied to the IMU measurements. The filter is a uniformly-weighted moving window (boxcar) filter of configurable size. The filtering does not affect the values used by the internal filter, but only the output values.

WindowSize

The WindowSize parameters for each sensor define the number of samples at the IMU rate (default 400Hz) which will be averaged for each output measurement.

FilterMode

The FilterMode parameters for each sensor select which output quantities the filtering should be applied to. Filtering can be applied to either the uncompensated IMU measurements, compensated (HSI and biases compensated by onboard filters, if applicable), or both.

IMU Filtering Modes

Value	Description
0	No Filtering
1	Filtering performed only on raw uncompensated IMU measurements.
2	Filtering performed only on compensated IMU measurements.
3	Filtering performed on both uncompensated and compensated IMU measurements.

7.2.6 Delta Theta and Delta Velocity Configuration

Delta Theta and Delta Velocity Configuration

Register ID : 82 **Access :** Read / Write

Comment : This register contains configuration options for the internal coning/sculling calculations

Size (Bytes): 6

Example Response: \$VNRRG,82,0,0,0,0*65

Offset	Name	Format	Unit	Description
0	IntegrationFrame	uint8	-	Output frame for delta velocity quantities
1	GyroCompensation	uint8	-	Compensation to apply to angular rate
2	AccelCompensation	uint8	-	Compensation(s) to apply to accelerations
3	Reserved	uint8	-	Reserved for future use. Should be set to 0.
4	Reserved	uint16	-	Reserved for future use. Should be set to 0.

The Delta Theta and Delta Velocity Configuration register allows configuration of the onboard coning and sculling used to generate integrated motion values from the angular rate and acceleration IMU quantities. The fully-coupled coning and sculling integrals are computed at the IMU sample rate (nominal 400 Hz).

IntegrationFrame

The IntegrationFrame register setting selects the reference frame used for coning and sculling. Note that using any frame other than the body frame will rely on the onboard Kalman filter's attitude estimate. The factory default state is to integrate in the sensor body frame.

IntegrationFrame

Value	Description
0	Body frame
1	NED frame
2	ECEF frame

GyroCompensation

The GyroCompensation register setting selects the compensation to be applied to the angular rate measurements before integration. If bias compensation is selected, the onboard Kalman filter's real-time estimate of the gyro biases will be used to compensate the IMU measurements before integration. The factory default state is to integrate the uncompensated angular rates from the IMU.

GyroCompensation

Value	Description
0	None
1	Bias

AccelCompensation

The AccelCompensation register setting selects the compensation to be applied to the acceleration measurements before integration. If bias compensation is selected, the onboard Kalman filter's real-time

estimate of the accel biases will be used to compensate the IMU measurements before integration. The factory default state is to integrate the uncompensated acceleration from the IMU.

AccelCompensation

Value	Description
0	None
1	Bias

7.3 Factory Defaults

Settings Name	Default Factory Value
Magnetometer Compensation	1,0,0,0,1,0,0,0,1,0,0,0
Accelerometer Compensation	1,0,0,0,1,0,0,0,1,0,0,0
Gyro Compensation	1,0,0,0,1,0,0,0,1,0,0,0
Reference Frame Rotation	1,0,0,0,1,0,0,0,1
IMU Filtering Configuration	0,4,4,4,0,0,3,3,3,0
Delta Theta and Delta Velocity Configuration	0,0,0,0,0

7.4 Command Prompt

The command prompt provides a fast and simple means of configuring and monitoring the status of the sensor by typing commands to the unit using the serial port.

7.4.1 List Available Commands

Commands for the System subsystem can be accessed by typing in 'imu' at the command prompt. To view all available commands, type 'imu ?'. Below is a view of a terminal window showing a list of the available commands.

```
imu ?  
  
Imu Module Commands:  
  
Command:      Description:  
-----  
info         Imu specific information such as serial number and firmware version.  
meas        Current Imu measurement, and run-time statistics.
```

7.4.2 IMU Info

```
imu info  
  
----- Imu Information -----  
  
Magnetometer - HSI Settings (Register 44)  
  Mode : Using Onboard  
  
Magnetometer - User HSI Calibration (Register 23)  
  +01.000 +00.000 +00.000 +00.000  
  +00.000 +01.000 +00.000 +00.000  
  +00.000 +00.000 +01.000 +00.000  
  
Magnetometer - Onboard HSI Calibration (Register 47)  
  +01.000 +00.000 +00.000 -00.000  
  +00.000 +01.000 +00.000 -00.000  
  +00.000 +00.000 +01.000 -00.000  
  
Accelerometer - User Calibration (Register 25)  
  +01.000 +00.000 +00.000 +00.000  
  +00.000 +01.000 +00.000 +00.000  
  +00.000 +00.000 +01.000 +00.000  
  
Sensor Self Test: (performed at startup)  
  Mag   : Passed  
  Accel : Passed  
  Gyro  : Passed  
  Pres  : Passed  
  
-----
```

7.4.3 IMU Meas

```
imu meas
----- Imu Measurement -----
Current Sensor Measurements:
Mag X      : -000.866 [Gauss]
Mag Y      : +001.016 [Gauss]
Mag Z      : +002.365 [Gauss]
Acel X     : +004.178 [m/s]
Acel Y     : -000.637 [m/s]
Acel Z     : -008.927 [m/s]
Gyro X     : -000.417 [deg/s]
Gyro Y     : +000.668 [deg/s]
Gyro Z     : -001.102 [deg/s]
Temp       : +027.94 [C]
Temp Rate  : +0.04 [C/min]
Pres       : +101.36 [kPa]

Current Sensor Noise: (measured over last 5 seconds)
Sensor  Units  X-Axis  Y-Axis  Z-Axis
Mag     mGauss  +03.228 +02.934 +04.159
Accel   mg      +01.854 +02.115 +02.872
Gyro    deg/s   +0.0631 +0.0544 +0.0580
Temp    C       +0.0026
Pres    Pa      +007.36

Minimum Sensor Noise: (since startup)
Sensor  Units  X-Axis  Y-Axis  Z-Axis
Mag     mGauss  +02.877 +02.659 +03.673
Accel   mg      +01.785 +01.966 +02.599
Gyro    deg/s   +0.0587 +0.0487 +0.0537
Temp    C       +0.0011
Pres    Pa      +006.13

Minimum Sensor Measurement: (since startup)
Sensor  Units  X-Axis  Y-Axis  Z-Axis
Mag     Gauss  -00.236 +00.244 +00.577
Accel   g      +00.414 -00.077 -00.949
Gyro    deg/s  -002.92 -005.33 -002.03
Temp    C      +27.83
Pres    kPa    +101.30

Maximum Sensor Measurement: (since startup)
Sensor  Units  X-Axis  Y-Axis  Z-Axis
Mag     Gauss  +00.000 +00.271 +00.611
Accel   g      +00.439 +00.000 +00.000
Gyro    deg/s  +002.02 +006.44 +000.00
Temp    C      +28.01
Pres    kPa    +101.38

Sensor Saturation Events: (since startup)
Sensor  X-Axis  Y-Axis  Z-Axis
Mag     0      0      0
Accel   0      0      0
Gyro    0      0      0
Pressure 0
Temp    0
```

8 GNSS Subsystem

8.1 Measurement Registers

8.1.1 GNSS Solution - LLA

GNSS Solution - LLA					
Register ID :	58	Async Header :	GPS	Access :	Read Only
Comment :					
Size (Bytes):	72				
Example Read	\$VNRRG,58,333733.000159,1694,3,05,+32.95622080,-096.71415970,+00169.457,-				
Response:	000.850,-000.580,-002.860,+005.573,+003.644,+009.760,+003.320,2.00E-08*0E				
Offset	Name	Format	Unit	Description	
0	Time	double	sec	GPS time of week in seconds.	
8	Week	uint16	week	GPS week.	
10	GNSSFix	uint8	-	GNSS fix type. See table below.	
11	NumSats	uint8	-	Number of GNSS satellites used in solution.	
12	-	-	-	--- 4 PADDING BYTES ---	
16	Latitude	double	deg	Latitude in degrees.	
24	Longitude	double	deg	Longitude in degrees.	
32	Altitude	double	m	Altitude above ellipsoid. (WGS84)	
40	NedVelX	float	m/s	Velocity measurement in north direction.	
44	NedVelY	float	m/s	Velocity measurement in east direction.	
48	NedVelZ	float	m/s	Velocity measurement in down direction.	
52	NorthAcc	float	m	North position accuracy estimate. (North)	
56	EastAcc	float	m	East position accuracy estimate. (East)	
60	VertAcc	float	m	Vertical position accuracy estimate. (Down)	
64	SpeedAcc	float	m/s	Speed accuracy estimate.	
68	TimeAcc	float	sec	Time accuracy estimate.	

GNSS Fix

Value	Description
0	No fix
1	Time only
2	2D
3	3D

This register provides the GNSS PVT (position, velocity, & time) solution from GNSS receiver A. This is the GNSS receiver that is used by the INS (Inertial Navigation System) Kalman filter for position and velocity inputs.



You can configure the device to output this register at a fixed rate using the Async Data Output Type Register in the System subsystem. Once configured the data in this register will be sent out with the \$VNGPS header.

8.1.2 GNSS Solution - ECEF

GNSS Solution – ECEF				
Register ID :	59	Async Header :	GPE	Access : Read Only
Comment :	Available at 5Hz only.			
Size (Bytes):	72			
Example Read Response:	\$VNRRG,59,333752.800322,1694,3,06,-0626351.600,-5320522.490,+3449975.910,-000.810,-002.970,+000.850,+010.170,+010.170,+010.170,+002.740,1.80E-08*35			
Offset	Name	Format	Unit	Description
0	Tow	double	sec	GPS time of week.
8	Week	uint16	week	Current GPS week.
10	GNSSFix	uint8	-	GNSS fix type. See table below.
11	NumSats	uint8	-	Number of GNSS satellites used in solution.
12	-	-	-	--- 4 PADDING BYTES ---
16	PositionX	double	m	ECEF X coordinate.
24	PositionY	double	m	ECEF Y coordinate.
32	PositionZ	double	m	ECEF Z coordinate.
40	VelocityX	float	m/s	ECEF X velocity.
44	VelocityY	float	m/s	ECEF Y velocity.
48	VelocityZ	float	m/s	ECEF Z velocity.
52	PosAccX	float	m	ECEF X position accuracy estimate.
56	PosAccY	float	m	ECEF Y position accuracy estimate.
60	PosAccZ	float	m	ECEF Z position accuracy estimate.
64	SpeedAcc	float	m/s	Speed accuracy estimate.
68	TimeAcc	float	sec	Time accuracy estimate.

GNSS Fix

Value	Description
0	No fix
1	Time only
2	2D
3	3D

This register provides the GNSS PVT (position, velocity, & time) solution from GNSS receiver A. This is the GNSS receiver that is used by the INS (Inertial Navigation System) Kalman filter for position and velocity inputs.



You can configure the device to output this register at a fixed rate using the Async Data Output Type Register in the System subsystem. Once configured the data in this register will be sent out with the \$VNGPE header.

8.1.3 GNSS2 Solution - LLA

GNSS2 Solution - LLA				
Register ID :	103	Async Header :	G2S	Access : Read Only
Comment :	The calculated navigation solution of the Ant B receiver, expressed in the LLA/NED frames. Updates at the GNSS rate (5Hz default).			
Size (Bytes):	72			
Example Read Response:	\$VNRRG,103,505020.999614,1941,3,13,+32.89195540,-096.70376740,+00165.491,+000.000,-000.008,-000.025,+001.320,+001.303,+003.259,+000.098,2.00E-09*35			
Offset	Name	Format	Unit	Description
0	Time	double	sec	GPS time of week in seconds.
8	Week	uint16	week	GPS week.
10	GNSSFix	uint8	-	GNSS fix type. See table below.
11	NumSats	uint8	-	Number of GNSS satellites used in solution.
12	-	-	-	--- 4 PADDING BYTES ---
16	Latitude	double	deg	Latitude in degrees.
24	Longitude	double	deg	Longitude in degrees.
32	Altitude	double	m	Altitude above ellipsoid. (WGS84)
40	NedVelX	float	m/s	Velocity measurement in north direction.
44	NedVelY	float	m/s	Velocity measurement in east direction.
48	NedVelZ	float	m/s	Velocity measurement in down direction.
52	NorthAcc	float	m	North position accuracy estimate. (North)
56	EastAcc	float	m	East position accuracy estimate. (East)
60	VertAcc	float	m	Vertical position accuracy estimate. (Down)
64	SpeedAcc	float	m/s	Speed accuracy estimate.
68	TimeAcc	float	sec	Time accuracy estimate.

GNSS Fix

Value	Description
0	No fix
1	Time only
2	2D
3	3D



You can configure the device to output this register at a fixed rate using the Async Data Output Type Register in the System subsystem. Once configured, the data in this register will be sent out with the \$VNG2S header.

8.1.4 GNSS2 Solution - ECEF

GNSS2 Solution – ECEF				
Register ID :	104	Async Header :	G2E	Access : Read Only
Comment :	The calculated navigation solution of the Ant B receiver, expressed in the ECEF frame. Updates at the GNSS rate (5Hz default).			
Size (Bytes):	72			
Example Read Response:	\$VNRRG,104,505024.199617,1941,3,13,-0625837.176,-5324476.241,+3443992.903,-000.001,-000.020,+000.007,+001.311,+001.298,+003.198,+000.098,2.00E-09*03			
Offset	Name	Format	Unit	Description
0	Tow	double	sec	GPS time of week.
8	Week	uint16	week	Current GPS week.
10	GNSSFix	uint8	-	GNSS fix type. See table below.
11	NumSats	uint8	-	Number of GNSS satellites used in solution.
12	-	-	-	--- 4 PADDING BYTES ---
16	PositionX	double	m	ECEF X coordinate.
24	PositionY	double	m	ECEF Y coordinate.
32	PositionZ	double	m	ECEF Z coordinate.
40	VelocityX	float	m/s	ECEF X velocity.
44	VelocityY	float	m/s	ECEF Y velocity.
48	VelocityZ	float	m/s	ECEF Z velocity.
52	PosAccX	float	m	ECEF X position accuracy estimate.
56	PosAccY	float	m	ECEF Y position accuracy estimate.
60	PosAccZ	float	m	ECEF Z position accuracy estimate.
64	SpeedAcc	float	m/s	Speed accuracy estimate.
68	TimeAcc	float	sec	Time accuracy estimate.

GNSS Fix

Description	
Value	
0	No fix
1	Time only
2	2D
3	3D



You can configure the device to output this register at a fixed rate using the Async Data Output Type Register in the System subsystem. Once configured, the data in this register will be sent out with the \$VNG2E header.

8.2 Configuration Registers

8.2.1 GNSS Configuration

GNSS Configuration				
Register ID :		55	Access : Read / Write	
Comment :				
Size (Bytes):		5		
Example Response:		\$VNRRG,55,0,0,5,0,1*6B		
Offset	Name	Format	Unit	Description
0	Mode	uint8	-	GNSS mode. 0 = Use onboard GNSS. 1 = Use external GNSS. 2 = Use external VectorNav sensor as the GNSS.
1	PpsSource	uint8	-	GPS PPS mode. 0 = GPS PPS signal is present on the GPS_PPS pin (pin 24) and should trigger on a rising edge. 1 = GPS PPS signal is present on the GPS_PPS pin (pin 24) and should trigger on a falling edge. 2 = GPS PPS signal is present on the Syncln pin (pin 22) and should trigger on a rising edge. 3 = GPS PPS signal is present on the Syncln pin (pin 22) and should trigger on a falling edge.
2	Rate	uint8	-	GNSS navigation rate. Value must be set to 5.
3	TimeSyncDelta	uint8	-	Reserved for future use. Field should be set to zero.
4	AntPower	uint8	-	Antenna supply configuration. Values other than 1 are only supported on the VN300-SMD. 0 = Disable antenna power supply. 1 = Use internal antenna power supply (3V, 50mA combined). 2 = Use external antenna power supply (VANT pin, up to 5V and 100mA combined).

8.2.2 GNSS Antenna A Offset

GNSS Antenna A Offset

Register ID : 57

Access : Read / Write

Comment : Configures the position offset of GNSS antenna A from the VN-300 in the vehicle reference frame.

Size (Bytes): 12

Example Response: \$VNRRG,57,0,0,0*68

Offset	Name	Format	Unit	Description
0	PositionX	float	m	Relative position of GNSS antenna. (X-axis)
4	PositionY	float	m	Relative position of GNSS antenna. (Y-axis)
8	PositionZ	float	m	Relative position of GNSS antenna. (Z-axis)

The position of the GNSS antenna A relative to the sensor in the vehicle coordinate frame also referred to as the GNSS antenna lever arm. In the example scenario shown in the figure below, the GNSS antenna offset is X= +2.5m, Y= +0.0m, Z= -2.0m.

GNSS Antenna A Offset

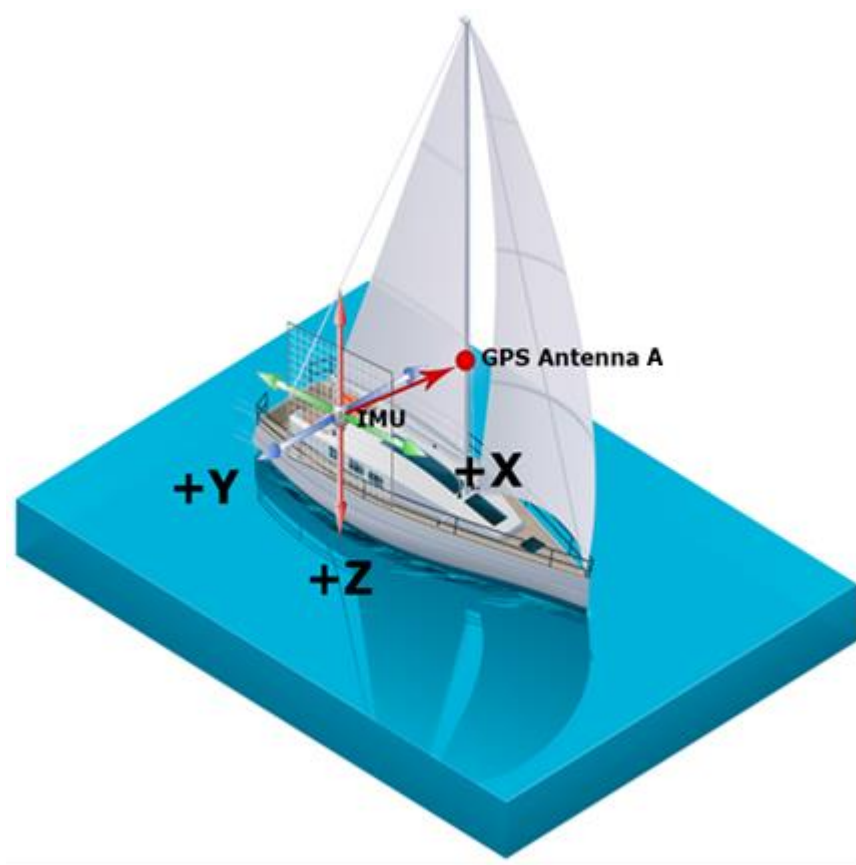

8.2.3 GNSS Compass Baseline

GNSS Compass Baseline

Register ID : 93 **Access :** Read / Write
Comment : Configures the position offset and measurement uncertainty of the second GNSS antenna relative to the first GNSS antenna in the vehicle reference frame.
Size (Bytes): 24
Example Response: \$VNRRG,93,1,0,0,0.0254,0.0254,0.0254*55

Offset	Name	Format	Unit	Description
0	PositionX	float	m	Relative position of GNSS antenna. (X-axis)
4	PositionY	float	m	Relative position of GNSS antenna. (Y-axis)
8	PositionZ	float	m	Relative position of GNSS antenna. (Z-axis)
12	UncertaintyX	float	m	Uncertainty in the X-axis position measurement.
16	UncertaintyY	float	m	Uncertainty in the Y-axis position measurement.
20	UncertaintyZ	float	m	Uncertainty in the Z-axis position measurement.



HEADING ACCURACY

The accuracy of the estimated heading is dependent upon the accuracy of the measured baseline between the two GNSS antennas. The factory default baseline is {1.0m, 0.0m, 0.0m}. If any other baseline is used, it is extremely important that the user accurately measures this baseline to ensure accurate heading estimates.

The heading accuracy is linearly proportional to the measurement accuracy of the position of GNSS antenna B with respect to GNSS antenna A, and inversely proportional to the baseline length.

Heading Error [deg] $\sim 0.57 * (\text{Baseline Error [cm]} / (\text{Baseline Length [m]}))$

On a 1 meter baseline, a 1 cm measurement error equates to heading error of 0.6 degrees.



MEASUREMENT UNCERTAINTY

For the VN-300 to function properly it is very important that the user supplies a reasonable measurement uncertainty that is greater than the actual uncertainty in the baseline measurement. The VN-300 uses the uncertainty supplied by the user to validate measurements that it receives from the GNSS receivers. If the user inputs an uncertainty that is lower than the actual error in the baseline measurement between the two antennas, the VN-300 will no longer be able to derive heading estimates from the GNSS.

It is recommended that you set the uncertainty equal to **twice** what you expect the worst case error to be in your baseline measurements. In many applications it is easier to measure more accurately in one direction than another. It is recommended that you set each of the X, Y, & Z uncertainties separately to reflect this, as opposed to using a single large value.

GNSS Antenna Measurements

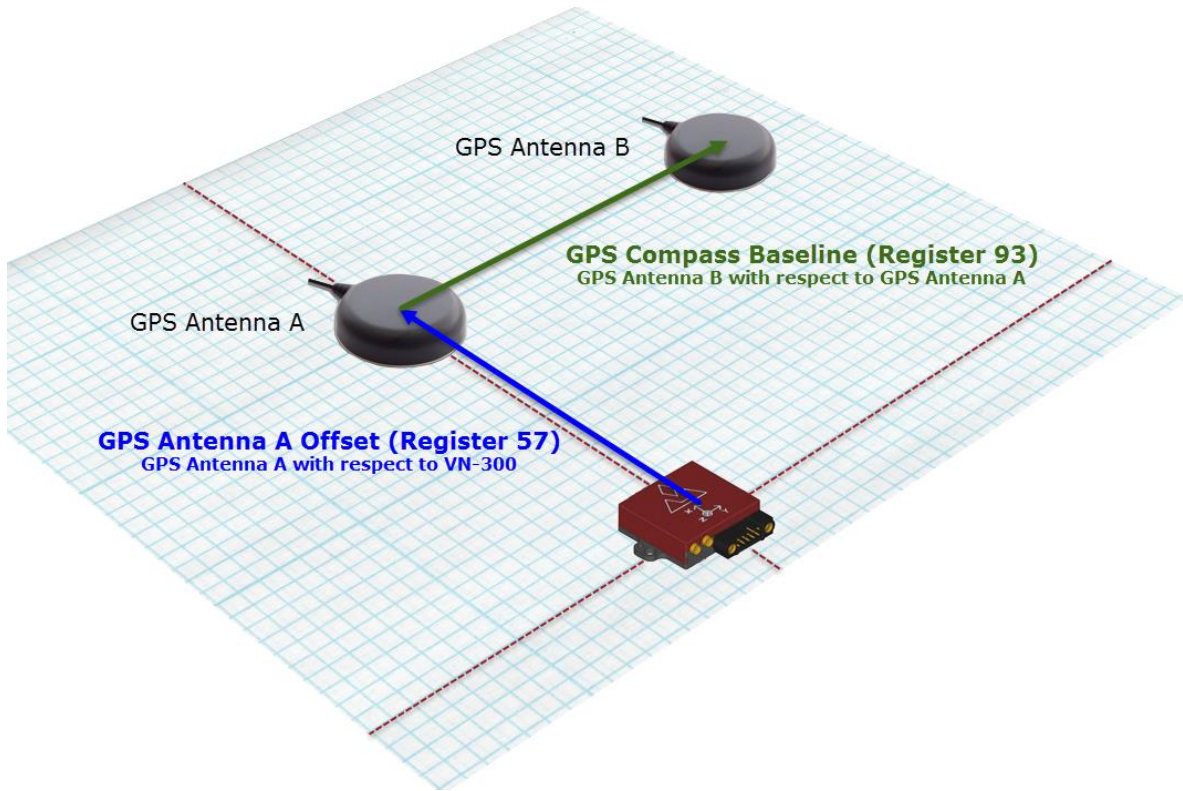

8.2.4 GNSS Sync Configuration

GNSS System Configuration				
Register ID :	100			Access : Read / Write
Comment :	Configuration of the GNSS Sync output pulse (VN300-SMD only)			
Size (Bytes):	16			
Example Response:	\$VNRRG,100,2,1,0,0,1000000,100000,0*6D			
Offset	Name	Format	Unit	Description
0	SyncMode	uint8	-	Sets when to output pulse.
1	Polarity	uint8	-	Pulse polarity – 0:Falling edge, 1:Rising edge
2	UseFreqDuty	uint8	-	Configure whether to specify the pulse based on Period and Pulse Width or based on Frequency and Duty Cycle
3	resv	uint8	-	Reserved for future use, should be set to zero.
4	PeriodFreq	uint32	us/Hz	The pulse period or frequency, depending on UseFreqDuty.
8	WidthDuty	uint32	us/2 ³²	The pulse width or duty cycle, depending on UseFreqDuty.
12	Offset	int32	ns	The fixed offset of the pulse relative to the GPS second.

GNSS Sync Modes

Mode	Description
0	Off Pulse will not fire
1	AlwaysOn – Pulse will always output, regardless of time fix
2	OnWhenLocked – Pulse will only output while a valid time fix is maintained.

The GNSS Sync pin can be used to output a very accurate timing signal based on time derived from the internal receiver. For applications where the timing pulse should only output when accurate and aligned to GPS time, use the OnWhenLocked mode. The AlwaysOn mode will always output, but will be less accurate when a time fix is not present, and may jump when the receiver time estimate is corrected.

The pulse can be specified in two ways, depending on the range and resolution of the desired pulse parameters.

The first way is to specify both the period and the pulse width in microseconds, with UseFreqDuty set to zero. For example, a 0.1s pulse at 1Hz would be configured as a 1000000us period with a 100000 pulse width. Note that because the times are in integer microseconds, the fastest output frequency that can be specified is a 500kHz signal (2us period) with a 1us pulse.

The other way to specify the output time pulse parameters is to set UseFreqDuty to 1 and specify the frequency directly in Hz. In this mode, the duty cycle is expressed as an integer where 0 is 0% duty cycle and the maximum possible uint32 value corresponds to a 100% duty cycle. For example, a ~0.1s pulse at 1Hz would be configured as 1Hz frequency with a duty cycle of 429496730.

8.3 Status Registers

8.3.1 GNSS Compass Estimated Baseline

GNSS Compass Estimated Baseline				
Register ID :	97			Access : Read
Comment :	Provides the estimated GNSS compass baseline measurement. The estimated position offset and measurement uncertainty is for the second GNSS antenna relative to the first GNSS antenna in the vehicle reference frame.			
Size (Bytes):	28			
Example Response:	\$VNRRG,97,0,0,0,1,0,0,0,0*60			
Offset	Name	Format	Unit	Description
0	EstBaselineUsed	uint8	-	Set to 1 when estimated baseline is being used.
1	Resv	uint8	-	Reserved for future use.
2	NumMeas	uint16	-	Number of measurements used by the estimated solution.
4	PositionX	float	m	Position of GNSS antenna B with respect to A. (X-axis)
8	PositionY	float	m	Position of GNSS antenna B with respect to A. (Y-axis)
12	PositionZ	float	m	Position of GNSS antenna B with respect to A. (Z-axis)
16	UncertaintyX	float	m	Uncertainty in the X-axis position measurement.
20	UncertaintyY	float	m	Uncertainty in the Y-axis position measurement.
24	UncertaintyZ	float	m	Uncertainty in the Z-axis position measurement.



To clear the current solution, write zeros to UseEstBaseline and NumMeas. The entire solution will be cleared.

8.3.2 GNSS Compass Startup Status

GNSS Compass Startup Status

Register ID : 98 **Access :** Read

Comment : Provides status information on the GNSS compass startup process.

Size (Bytes): 8

Example Response: \$VNRRG,98,046,+001.318*4E

Offset	Name	Format	Unit	Description
0	PercentComplete	uint8	-	The estimated startup process completion percent
4	CurrentHeading	float	deg	The current best heading estimate



The percentage may decrease if the satellites signal integrity is compromised during the startup process.

8.3.3 GNSS Compass Signal Health Status

GNSS Compass Signal Health Status				
Register ID :	86			Access : Read
Comment :	Provides several indicators that serve as an overall health status of the GNSS compass subsystem.			
Size (Bytes):	32			
Example Response:	\$VNRRG,86,13,10,50,13,9,51,13,9*7F			
Offset	Name	Format	Unit	Description
0	NumSatsPVT_1	float	-	Number of satellites available for PVT solution for receiver A.
4	NumSatsRTK_1	float	-	Number of satellites available for RTK solution for receiver A.
8	HighestCNO_1	float	dBHz	Highest CNO reported on receiver A.
12	NumSatsPVT_2	float	-	Number of satellites available for PVT solution for receiver B.
16	NumSatsRTK_2	float	-	Number of satellites available for RTK solution for receiver B.
20	HighestCNO_2	float	dBHz	Highest CNO reported on receiver B.
24	NumComSatsPVT	float	-	The number of common satellites that are used in the PVT solution on both receiver A and receiver B.
28	NumComSatsRTK	float	-	The number of common satellites that are used in the RTK solution on both receiver A and receiver B.



Example interpretations:

If PVT number is low, RTK number is low, but CNO is high (50) => Likely sky blockage

If PVT number is high, RTK number is low and CNO is low (<40) => If both receivers then probable jamming/indoors/under canopy

If PVT number is high, RTK number is low and CNO is low (<40) => If only one receiver then probable local jamming (e.g. laptop near antenna) or cable/antenna issue.

If NumSats common PVT/RTK is lower then this indicates sky blockage preventing the antennas from seeing the same satellites. For instance a wall between the two GNSS antennas would cause 8,8,50,8,8,50,0,0.



If a user is to display GNSS Compass RF quality then:

GREEN (Excellent Conditions):

- NumSatsPVT_1 & NumSatsPVT_2 (>= 12)
- HighestCNO_1 & HighestCNO_2 (>= 47)
- NumComSatsPVT & NumComSatsRTK (>= 12)

YELLOW (Fair Conditions):

- NumSatsPVT_1 & NumSatsPVT_2 (8 to 11)
- HighestCNO_1 & HighestCNO_2 (40 to 46)
- NumComSatsPVT & NumComSatsRTK (9 to 11)

RED (Poor Conditions):

- NumSatsPVT_1 & NumSatsPVT_2 (< 7)
- HighestCNO_1 & HighestCNO_2 (< 40)
- NumComSatsPVT & NumComSatsRTK (< 9)

It will take the receivers 1-2 minutes to get "full" tracking.

8.4 NMEA Messages

8.4.1 RMC – Recommended Minimum Sentence C

Example:

```
$GPRMC,193144.00,A,3253.508483,N,09642.202932,W,0.015,242.35,260116,3.44,E,D,V*51
```

Field	Structure	Format	Units	Example
1	RMC Header	\$GPRMC	n/a	
2	Time	hhmmss.ss		193144.00
3	Status	A	A – Data valid V – Data invalid	A
4,5	Latitude, N/S	ddmm.mm,a	Degrees minutes, Direction indicator	3253.508483,N
6,7	Longitude, E/W	ddmm.mm,a	Degrees minutes, Direction indicator	09642.202932,W
8	Speed over ground	x.xx	knots	0.015
9	Course over ground	x.xx	degrees True	242.35
10	Date	ddmmyy		260116
11,12	Magnetic variation, E/W	x.xx,a	Degrees minutes, Direction indicator	3.44,E
13	Mode Indicator	a		D
14	Navigational Status	a		V
15	Sentence terminator	*XX<CRLF>	Checksum	*51<CRLF>

8.4.2 GGA – Global Positioning System Fix Data

Example:

\$GPGGA,193144.00,3253.508483,N,09642.202932,W,2,10,0.83,185.976,M,-25.278,M,,0000*6A

Field	Structure	Format	Units	Example
1	GGA header	\$GPGGA	n/a	
2	Time	hhmm.ss		193144.00
3, 4	Latitude, N/S	ddmm.mm,a	Degrees minutes, Direction Indicator	3253.508483,N
5, 6	Longitude, E/W	dddmm.mm,a	Degrees minutes, Direction Indicator	09642.202932,W
7	Quality Indicator	a	0 - Fix invalid 1 - GNSS SPS mode, fix valid 2 - Differential GNSS, SPS mode, fix valid 6 - Estimated (dead reckoning) Mode	2
8	Number of satellites used	dd	00-12	10
9	Horizontal dilution of precision	x.xx		0.83
10, 11	Altitude, mean-sea-level, in meters	x.xx,a	Meters	185.976,M
12,13	Geoidal separation	x.xx,a	Meters	-25.278,M
14	Age of data	a		Not populated
15	Differential reference station ID	xxxx		Always "0000"
16	Sentence terminator	*XX<CRLF>	Checksum	*6A<CRLF>

8.4.3 GLL – Geographic Position

Example:

\$GPGLL,3253.508483,N,09642.202932,W,193144.00,A,D*70

Field	Structure	Format	Units	Example
1	GLL header	\$GPGLL	n/a	
2,3	Latitude, N/S	ddmm.mm,a	Degrees minutes, Direction Indicator	3253.508483,N
4,5	Longitude, E/W	dddmm.mm,a	Degrees minutes, Direction Indicator	09642.202932,W
6	Time	hhmmss.ss		193144.00
7	Status	a	V = Invalid A = Autonomous D = Differential	A
8	Mode	a	A = Autonomous D = Differential E = Estimated N = Data invalid	D
9	Sentence terminator	*XX<CRLF>	Checksum	*70<CRLF>

8.4.4 GSA – GNSS DOP and Active Satellites

Example:

Sample for less than 12 satellites

```
$GPGSA,A,3,01,10,11,12,14,18,22,25,26,31,,,1.34,0.83,1.05,1*18
```

Sample for 13 satellites. Prints 2 lines

```
$GPGSA,A,3,01,03,10,11,14,16,22,23,25,26,31,46,1.33,0.71,1.13,1*18
```

```
$GPGSA,A,3,51,,,,,,,,,,,,,1.33,0.71,1.13,1*1F
```

Field	Structure	Format	Units	Example
1	GSA header	\$GPGSA	n/a	\$GPGSA
2	Mode	a	M = Manual A = Automatic, allowed to automatically switch 2D/3D	A
3	Fix	d	1 = Fix unavailable 2 = 2D 3 = 3D	3
4-15	Satellite IDs for satellites used in solution	dd	Range: 01-99 01-32 reserved for GNSS 33-64 reserved for SBAS SV ID = WAAS PRN number - 87 65-99 are undefined	01,10,11,12,14,18,22,25,26,31,,,
16	pDOP	d.dd		1.34
17	hDOP	d.dd		0.83
18	vDOP	d.dd		1.05
19	SysID	d	1 = L1 C/A	1
20	Sentence terminator	*XX<CRLF>	Checksum	*18<CRLF>

8.4.5 GSV – GNSS Satellites in View

Example:

Sample with 14 satellites in view

```
$GPGSV,4,1,14,01,26,305,45,03,02,311,37,10,49,119,48,11,21,282,44,1*62
```

```
$GPGSV,4,2,14,12,08,043,36,14,53,033,49,18,17,126,41,22,83,005,47,1*62
```

```
$GPGSV,4,3,14,25,26,078,48,26,08,171,43,31,72,199,49,32,38,316,,1*6F
```

```
$GPGSV,4,4,14,46,50,182,45,51,50,199,45,1*6D
```

Field	Structure	Format	Units	Example
1	GSV header	\$GPGSV	n/a	\$GPGSV
2	Total number of sentences	d	n/a Range: 1 to 9	4
3	Sentence number	d	n/a Range: 1 to 9	1
4	Total number of satellites in view	d	n/a	14
5	Satellite ID number	dd		01
6	Elevation	dd	degrees Range: 00 to 90	26
7	Azimuth	ddd	degrees True Range: 000 to 359	305
8	SNR (C/No)	dd	dB-Hz Range: 00 to 99	45
9-12	2nd SatID,El,Az,SNR	dd,dd,ddd,dd		03,02,311,37
13-16	3rd SatID,El,Az,SNR	dd,dd,ddd,dd		10,49,119,48
17-20	4th SatID,El,Az,SNR	dd,dd,ddd,dd		11,21,282,44
21	Signal ID	x	1= L1 C/A	1
22	Sentence terminator	*XX<CRLF>	Checksum	*62<CRLF>

8.4.6 HDT – Heading True

Example:

\$GPHDT,307.84,T*0D

Field	Structure	Format	Units	Example
1	THS header	\$GPTHS	n/a	\$GPTHS
2	Heading	d.dd	degrees True Range: 0.00-359.99	307.84
3	Heading Indicator	T	T = Indicates heading relative to True North	T
4	Sentence terminator	*XX<CRLF>	Checksum	*0D<CRLF>

8.4.7 THS – True Heading & Status

Example:

\$GPPTS,88.01,A*36

Field	Structure	Format	Units	Example
1	THS header	\$GPTHS	n/a	\$GPTHS
2	Heading	d.dd	degrees True Range: 0.00-359.99	88.01
3	Mode	a	A = Autonomous E = Estimated (dead reckoning) V = Data not valid	A
4	Sentence terminator	*XX<CRLF>	Checksum	*36<CRLF>

8.4.8 VTG – Course Over Ground And Ground Speed

Example:

\$GPVTG,242.35,T,238.91,M,0.015,N,0.028,K,D*2B

Field	Structure	Format	Units	Example
1	VTG header	\$GPVTG	n/a	\$GPVTG
2,3	Course over ground	d.dd,T	degrees True Range: 0.00-359.99	242.35,T
4,5	Course over ground	d.dd,M	degrees Magnetic Range: 0.00-359.99	238.91,M
6,7	Speed over ground	d.ddd,N	knots	0.015,N

8.4.9 ZDA – UTC Time & Date

Example:

\$GPZDA,193144.00,26,01,2016,00,00*6C

Field	Structure	Format	Units	Example
1	ZDA header	\$xxZDA	n/a	\$GPZDA
2	UTC Time	hhmmss.ss		193144.00
3	UTC Day	dd	Range: 01-31	26
4	UTC Month	dd	Range: 01-12	01
5	UTC Year	dddd		2016
6	Local Zone hours	dd	Always "00"	00
7	Local Zone minutes	dd	Always "00"	00
8	Sentence terminator	*XX<CRLF>	Checksum	*6C<CRLF>

8.4.10 PASHR

Example:

\$PASHR,193144.00,88.01,T,+0.14,-0.49,,0.088,0.088,19.922,1*27

Field	Structure	Format	Units	Example
1	PASHR header	\$PASHR	n/a	\$PASHR
2	Time	hhmmss.ss	UTC	193144.00
3, 4	Heading	d.dd, T	degrees True Range: 0.00-359.99	88.01, T
5	Roll	+d.dd	decimal degrees with +/- sign displayed	+0.14
6	Pitch	+d.dd	decimal degrees with +/- sign displayed	-0.49
7	Heave (reserved)		Not populated	
8	Roll accuracy	d.ddd	standard deviation in decimal degrees	0.088
9	Pitch accuracy	d.ddd	standard deviation in decimal degrees	0.088
10	Heading accuracy	d.ddd	standard deviation in decimal degrees	19.922
11	GNSS update quality flag	d	0 = No Position 1 = All non-RTK fixed integer positions 2 = RTK fixed integer position	1
12	Sentence terminator	*XX<CRLF>	Checksum	*27<CRLF>

8.4.11 TSS1

Example:

Fixed length of 27 characters

Sample: :00FFFF 0000F 0014 -0048

Field	Structure	Format	Units	Example
1	Start of packet	ASCII (0x3A)	n/a	:
2	Horizontal acceleration	xx	0.03835 m/ss Range: 0-9.81	00
3	Vertical acceleration	xxxx	0.000625 m/ss Range:-20.48 to 20.48	FFFF
4	Space character	ASCII (0x20)		
5	Heave (Reserved)	mdddd	centimeters Not supported Always "0000"	"0000"
6	Status flag	a	h - Heading aided mode but unstable data F - Full aided mode and stable data	F
7	Roll angle	mdddd 1 char for sign " " if positive "-" if negative 4 char decimal number	0.01° Range: -90° to +90°	"0014"
8	Space character	ASCII (0x20)		
9	Pitch angle	mdddd 1 char for sign " " if positive "-" if negative 4 char decimal number	0.01° Range: -90° to +90°	"-0048"
10	Sentence terminator	<CRLF>		<CRLF>

8.5 Factory Defaults

Settings Name	Default Factory Value
GNSS Configuration	0,0,5,0,1
GNSS Antenna A Offset	0,0,0
GNSS Compass Estimated Baseline	0,0,0,0,0,0,0,0
GNSS Compass Baseline Config	1,0,0,0.0254,0.0254,0.0254

8.6 Command Prompt

The command prompt provides a fast and simple means of configuring and monitoring the status of the sensor by typing commands to the unit using the serial port.

8.6.1 List Available Commands

Commands for the System subsystem can be accessed by typing in 'GNSS' at the command prompt. To view all available commands, type 'GNSS ?'. Below is a view of a terminal window showing a list of the available commands.

```
GNSS ?

GNSS Module Commands:

Command:      Description:
-----      -
info          GNSS specific information such as serial number and firmware version.
meas          Current GNSS navigation solution.
sat           Current tracked satellite info.
raw           Current GNSS raw measurement data.
```

8.6.2 GNSS Info

```
GNSS info

----- Gps Information -----

Timing & Error Statistics:
  Update Rate   : 5 Hz
  Last Pps      : 0.85 s
  Last Nav Msg  : 0.18 s
  Last 3d Fix   : 0.19 s
  Time to Fix   : 0.19 s
  Max Meas Gap  : 6.50 s
  Max 3d Gap    : 31.77 s
  Packet Cnt    : 282
  3d Fix Cnt    : 182
  Lost Fix Cnt  : 0
  Invalid Cnt   : 0
  Restart Cnt   : 0
  Pps Std Dev   : 011.7 us

GNSS Compass Statistics:
  Last GNSS Compass Msg      : 0.09 s
  GNSS Compass Packet Cnt    : 282
  Resets from loss of PVT sol : 0
  Resets from loss of compass : 0

-----
```

8.6.3 GNSS Meas

GNSS meas

```
----- Gps Measurement -----  
Gnss 1 Solution:  
Week:Tow      : 2046:491935.199952 (wk:s)  
Sats visible  : 15  
Sats used     : 12  
Latitude      : +32.89195100 deg  
Longitude     : -096.70375990 deg  
Altitude (WGS84) : +00165.309 m  
Altitude (MSL) : +00190.588 m  
Pos Acc       : 01.39 01.37 03.19 m  
Vel Acc       : 00.05 00.05 00.12 m/s  
Speed Acc     : 00.14 m/s  
Time Acc      : 1 ns  
P/H/V DOPs   : 01.50 00.76 01.30  
N/E/G/T DOPs : 00.54 00.53 01.70 00.80  
Gnss 2 Solution:  
Week:Tow      : 2046:491935.199557 (wk:s)  
Sats visible  : 15  
Sats used     : 10  
Latitude      : +32.89194720 deg  
Longitude     : -096.70375150 deg  
Altitude (WGS84) : +00160.719 m  
Altitude (MSL) : +00185.997 m  
Pos Acc       : 16.08 15.52 36.14 m  
Vel Acc       : 00.28 00.27 00.68 m/s  
Speed Acc     : 00.78 m/s  
Time Acc      : 11 ns  
P/H/V DOPs   : 01.61 00.81 01.39  
N/E/G/T DOPs : 00.58 00.56 01.81 00.82  
-----
```

8.6.4 GNSS Sat

Provides detailed information on each satellite in view.

```

GNSS sat
----- GNSS Satellite Info -----
Gnss 1 Satellite Info:
  Sys SV  CN0  Residual  Nav  Hdg  Qi  El  Az  Orbit  Healthy  DGNSS
  G   3   48   +0.70     Y   Y   7  58 271 Eph    Y      N
  G  14   42   -0.20     Y   Y   7  28 101 Eph    Y      N
  G  16   48   +0.20     Y   Y   7  62 157 Eph    Y      Y
  G  22   49   -0.40     Y   Y   7  56 217 Eph    Y      Y
  G  23   46   -0.60     Y   Y   7  36 314 Eph    Y      N
  G  26   49   -0.60     Y   Y   7  65  79 Eph    Y      Y
  G  31   43   +0.80     Y   Y   7  30  50 Eph    Y      Y
  G  32   42   -0.50     Y   Y   7   8 113 Eph    Y      Y
  E   1   47   +0.30     Y   Y   7  73  20 Eph    Y      N
  E   9   42   +0.30     Y   Y   7  26 317 Eph    Y      N
  E  19   38   +0.80     Y   Y   7  40 138 Eph    Y      N
  S  133  45   +0.00     N   Y   7  51 182 Eph    N      N
  S  135  44   +0.00     N   Y   7  36 234 Eph    N      N
  S  138  47   +0.00     N   Y   7  50 199 Eph    N      N
  G   1   36   -1.30     N   N   7   5 228 Eph    Y      Y
  G   4   49   +0.00     N   N   7 -91  0 Eph    N      N
  G   9   33   +2.70     N   N   7   4 304 Eph    Y      N
  G  29   37   +0.90     N   N   7   3  48 Eph    Y      N
  E  14   32   +0.00     N   N   7 -91  0 Eph    N      N

Gnss 2 Satellite Info:
  Sys SV  CN0  Residual  Nav  Hdg  Qi  El  Az  Orbit  Healthy  DGNSS
  G   3   49   +0.30     Y   Y   7  58 271 Eph    Y      Y
  G  14   41   -0.10     Y   Y   7  28 101 Eph    Y      N
  G  16   49   +0.20     Y   Y   7  62 156 Eph    Y      Y
  G  22   50   -0.70     Y   Y   7  56 217 Eph    Y      Y
  G  23   47   -0.90     Y   Y   7  36 314 Eph    Y      Y
  G  26   49   -0.20     Y   Y   7  65  79 Eph    Y      Y
  G  31   46   +0.10     Y   Y   7  30  50 Eph    Y      Y
  G  32   43   +0.80     Y   Y   7   8 113 Eph    Y      Y
  E   1   47   -0.30     Y   Y   7  73  20 Eph    Y      N
  E   9   41   +0.20     Y   Y   7  26 317 Eph    Y      N
  E  19   39   +0.10     Y   Y   7  40 138 Eph    Y      N
  S  133  45   +0.00     N   Y   7  51 182 Eph    N      N
  S  135  46   +0.00     N   Y   7  36 234 Eph    N      N
  S  138  48   +0.00     N   Y   7  50 199 Eph    N      N
  G   1   37   -1.40     N   N   7   5 228 Eph    Y      Y
  G   4   50   +0.00     N   N   7 -91  0 Eph    N      N
  G   9   34   +2.30     N   N   7   4 304 Eph    Y      Y
  G  27   32   -0.50     N   N   7   5 155 Eph    Y      Y
  G  29   39   +0.70     N   N   7   3  48 Eph    Y      N
  E  14   36   +0.00     N   N   7 -91  0 Eph    N      N

```

8.6.5 GNSS Raw

Provides raw pseudorange, carrier phase, and doppler measurements for each satellite in view.

```

GNSS raw

----- GNSS Raw Measurements -----

Gnss Receiver 1 Raw Measurements:
Tow: 488291.789000      Week: 1945
Sys SV  CN0  Flags      PR          CP          DP
G   1   30  CPU (5E)   21995216.435 115585664.580 -1111.750
G   3   45  CPU (5E)   17539247.808  92169370.399  1347.675
G   4   46  CPX (1E)   17382418.287  91345223.151   21.029
G  14   37  CPU (5E)   19573046.465 102857056.875 -788.781
G  16   45  CPU (5E)   17038211.328  89536402.969  2981.531
G  22   46  CPX (1E)   17609200.618  92536980.910 -256.555
G  23   44  CPX (1E)   19125071.159 100502923.599  3862.426
G  26   46  CPU (5E)   17362856.592  91242424.544   649.715
G  29   36  CPX (1E)   21861788.056 114884474.657  1053.165
G  31   40  CPU (5E)   19487565.265 102407843.143 -1309.358
G  32   39  CPX (1E)   21602334.362 113521053.145 -1513.539
S 133   42  CPU (5E)   33581171.377 176470249.093  1363.036
S 135   41  CPU (5E)   34706061.849 182381586.397  1284.395
S 138   44  CPU (5E)   33634030.303 176748023.904  1285.646
E   1   44  CPX (1E)   20037934.669 105300069.617   387.364
E   9   38  CPX (1E)   20704996.377 108805506.130  3754.213
E  14   31  CPX (1E)   22905458.870 120369000.152  5929.075
E  19   35  CPX (1E)   21708714.613 114080079.734  -864.291

Gnss Receiver 2 Raw Measurements:
Tow: 488291.796000      Week: 1945
Sys SV  CN0  Flags      PR          CP          DP
G   1   33  CPU (5E)   24143253.395 126873636.789 -1942.844
G   3   46  CPX (1E)   19687282.117 103457364.551   517.010
G   4   47  CPX (1E)   19530453.118 102633220.531 -809.564
G   9   29  CPU (5E)   23883872.888 125510648.972  3475.966
G  14   37  CPU (5E)   21721080.948 114145048.940 -1619.466
G  16   46  CPU (5E)   19186245.410 100824400.286  2150.645
G  22   46  CPX (1E)   19757234.490 103824970.459 -1087.305
G  23   44  CPX (1E)   21273106.758 111790930.112  3031.521
G  26   46  CPX (1E)   19510891.075 102530424.189 -180.786
G  27   29  CPU (5E)   23795645.058 125046947.785  3291.902
G  29   36  CPU (5E)   24009822.382 126172466.423   222.601
G  31   43  CPX (1E)   21635600.079 113695843.911 -2139.902
G  32   39  CPU (5E)   23750370.363 124809052.890 -2344.513
S 133   42  CPU (5E)   35729205.685 187758240.001   532.729
S 135   43  CPU (5E)   36854095.774 193669578.017   453.580
S 138   45  CPU (5E)   35782064.419 188036015.915   455.008
E   1   44  CPX (1E)   22185968.942 116588061.137 -443.474
E   9   38  CPX (1E)   22853029.883 120093497.120  2923.180
E  14   30  CPX (1E)   25053493.806 131657041.908  5098.145
E  19   36  CPX (1E)   23856748.398 125368053.621 -1695.151

Legend: T=Time Lock, C=Code Lock, P=Phase Lock, S=Phase Slip, A=Half-Wave Amb,
U=Half-Wave Sub
-----

```

9 Attitude Subsystem

9.1 Commands

9.1.1 Set Gyro Bias Command

This command will instruct the VN-300 to copy the current gyro bias estimates into register 74. After sending this command you will need to issue the write settings command in the System subsystem to save the state of this register to flash memory. Once saved the VN-300 will use these bias estimates as the initial state at startup.

Example Gyro Bias Command

Example Command	Message
UART Command	\$VNSGB*XX
UART Response	\$VNSGB*XX
SPI Command (8 bytes)	0C 00 00 00 (shown as hex)
SPI Response (8 bytes)	00 0C 00 00 (shown as hex)

9.1.2 Set Initial Heading Command

This command will instruct the VN-300 to set the heading to the angle given by the user. At startup the VN-300 requires 2 to 15 minutes to acquire a GNSS compass fix and to verify that the heading given by the GNSS compass algorithm is correct and not induced by multipath errors. Typically with clear sky conditions the GNSS compass will acquire a fix within 45 seconds at startup. If multipath conditions are present however, the initial heading provided by the compass may not be correct. As such the VN-300 runs a verification check on the GNSS compass heading until it is certain that the heading that is being reported is correct prior to using it to initialize the internal INS kalman filter. This process takes some time to complete. If the user knows the initial heading at startup, the user can provide this initial heading using this command which assist the VN-300 in expediting the startup process. Once the VN-300 receives an initial heading from the user it will immediately initialize the INS Kalman filter. Since the heading given by the user will be used to validate any subsequent GNSS compass heading measurements, it is important that the heading angle given by the user is accurate relative to true north to within a few degrees.

Example Set Initial Heading Command

Example Command	Message
UART Command	\$VNSIH,+045.713*67
UART Response	\$VNSIH,+045.713*67



It is important that the initial heading you provide to the VN-300 is accurate to within 5 degrees of the true heading of the sensor relative to true north. If the initial heading provided is not within this accuracy window, then the INS may lose GNSS compass tracking after receiving the command.

9.2 Measurement Registers

9.2.1 Yaw Pitch Roll

Yaw, Pitch, and Roll				
Register ID :	8	Async Header :	YPR	Access : Read Only
Comment :	Attitude solution as yaw, pitch, and roll in degrees. The yaw, pitch, and roll is given as a 3,2,1 Euler angle rotation sequence describing the orientation of the sensor with respect to the inertial North East Down (NED) frame.			
Size (Bytes):	12			
Example Response:	\$VNRRG,8,+006.271,+000.031,-002.000*66			
Offset	Name	Format	Unit	Description
0	Yaw	float	deg	Yaw angle (Range: +/- 180°).
4	Pitch	float	deg	Pitch angle (Range: +/- 90°).
8	Roll	float	deg	Roll angle (Range: +/- 180°).



You can configure the device to output this register at a fixed rate using the Async Data Output Type Register in the System subsystem. Once configured the data in this register will be sent out with the \$VNYPR header.

9.2.2 Attitude Quaternion

Quaternion				
Register ID :	9	Async Header :	QTN	Access : Read Only
Comment :	Attitude solution as a quaternion.			
Size (Bytes):	16			
Example Response:	\$VNRRG,9,-0.017386,-0.000303,+0.055490,+0.998308*4F			
Offset	Name	Format	Unit	Description
0	Quat[0]	float	-	Calculated attitude as quaternion.
4	Quat[1]	float	-	Calculated attitude as quaternion.
8	Quat[2]	float	-	Calculated attitude as quaternion.
12	Quat[3]	float	-	Calculated attitude as quaternion. Scalar component.



You can configure the device to output this register at a fixed rate using the Async Data Output Type Register in the System subsystem. Once configured the data in this register will be sent out with the \$VNQTN header.

9.2.3 Yaw, Pitch, Roll, Magnetic, Acceleration, and Angular Rates

Yaw, Pitch, Roll, Magnetic, Acceleration, and Angular Rates

Register ID : 27 **Async Header :** YMR **Access :** Read Only
Comment : Attitude solution, magnetic, acceleration, and compensated angular rates.
Size (Bytes): 48

Example Response: \$VNRRG,27,+006.380,+000.023,-001.953,+1.0640,-
0.2531,+3.0614,+00.005,+00.344,-09.758,-0.001222,-0.000450,-0.001218*4F

Offset	Name	Format	Unit	Description
0	Yaw	float	deg	Calculated attitude heading angle in degrees (Range: +/- 180°).
4	Pitch	float	deg	Calculated attitude pitch angle in degrees (Range: +/- 90°).
8	Roll	float	deg	Calculated attitude roll angle in degrees (Range: +/- 180°).
12	MagX	float	Gauss	Compensated magnetometer measurement in x-axis.
16	MagY	float	Gauss	Compensated magnetometer measurement in y-axis.
20	MagZ	float	Gauss	Compensated magnetometer measurement in z-axis.
24	AccelX	float	m/s ²	Compensated accelerometer measurement in x-axis.
28	AccelY	float	m/s ²	Compensated accelerometer measurement in y-axis.
32	AccelZ	float	m/s ²	Compensated accelerometer measurement in z-axis.
36	GyroX	float	rad/s	Compensated angular rate in x-axis.
40	GyroY	float	rad/s	Compensated angular rate in y-axis.
44	GyroZ	float	rad/s	Compensated angular rate in z-axis.



You can configure the device to output this register at a fixed rate using the Async Data Output Type Register in the System subsystem. Once configured the data in this register will be sent out with the \$VNYMR header.

9.2.4 Quaternion, Magnetic, Acceleration and Angular Rates

Quaternion, Magnetic, Acceleration, and Angular Rates				
Register ID :	15	Async Header :	QMR	Access : Read Only
Comment :	Attitude solution, magnetic, acceleration, and compensated angular rates.			
Size (Bytes):	52			
Example Response:	\$VNRRG,15,-0.017057,-0.000767,+0.056534,+0.998255,+1.0670,-0.2568,+3.0696,-00.019,+00.320,-09.802,-0.002801,-0.001186,-0.001582*65			
Offset	Name	Format	Unit	Description
0	Quat[0]	float	-	Calculated attitude as quaternion.
4	Quat[1]	float	-	Calculated attitude as quaternion.
8	Quat[2]	float	-	Calculated attitude as quaternion.
12	Quat[3]	float	-	Calculated attitude as quaternion. Scalar component.
16	MagX	float	Gauss	Compensated magnetometer measurement in x-axis.
20	MagY	float	Gauss	Compensated magnetometer measurement in y-axis.
24	MagZ	float	Gauss	Compensated magnetometer measurement in z-axis.
28	AccelX	float	m/s ²	Compensated accelerometer measurement in x-axis.
32	AccelY	float	m/s ²	Compensated accelerometer measurement in y-axis.
36	AccelZ	float	m/s ²	Compensated accelerometer measurement in z-axis.
40	GyroX	float	rad/s	Compensated angular rate in x-axis.
44	GyroY	float	rad/s	Compensated angular rate in y-axis.
48	GyroZ	float	rad/s	Compensated angular rate in z-axis.



You can configure the device to output this register at a fixed rate using the Async Data Output Type Register in the System subsystem. Once configured the data in this register will be sent out with the \$VNQMR header.

9.2.5 Magnetic Measurements

Magnetic Measurements				
Register ID :	17	Async Header :	MAG	Access : Read Only
Comment :	Magnetometer measurements.			
Size (Bytes):	12			
Example Response:	\$VNRRG,17,+1.0647,-0.2498,+3.0628*66			
Offset	Name	Format	Unit	Description
0	MagX	float	Gauss	Compensated magnetometer measurement in x-axis.
4	MagY	float	Gauss	Compensated magnetometer measurement in y-axis.
8	MagZ	float	Gauss	Compensated magnetometer measurement in z-axis.



You can configure the device to output this register at a fixed rate using the Async Data Output Type Register in the System subsystem. Once configured the data in this register will be sent out with the \$VNRMAG header.

9.2.6 Acceleration Measurements

Acceleration Measurements				
Register ID :	18	Async Header :	ACC	Access : Read Only
Comment :	Acceleration measurements.			
Size (Bytes):	12			
Example Response:	\$VNRRG,18,+00.013,+00.354,-09.801*65			
Offset	Name	Format	Unit	Description
0	AccelX	float	m/s ²	Compensated accelerometer measurement in x-axis.
4	AccelY	float	m/s ²	Compensated accelerometer measurement in y-axis.
8	AccelZ	float	m/s ²	Compensated accelerometer measurement in z-axis.



You can configure the device to output this register at a fixed rate using the Async Data Output Type Register in the System subsystem. Once configured the data in this register will be sent out with the \$VNACC header.

9.2.7 Angular Rate Measurements

Angular Rate Measurements				
Register ID :	19	Async Header :	GYR	Access : Read Only
Comment :	Compensated angular rates.			
Size (Bytes):	12			
Example Response:	\$VNRRG,19,+0.002112,-0.000362,-0.000876*6C			
Offset	Name	Format	Unit	Description
0	GyroX	float	rad/s	Compensated angular rate in x-axis.
4	GyroY	float	rad/s	Compensated angular rate in y-axis.
8	GyroZ	float	rad/s	Compensated angular rate in z-axis.



You can configure the device to output this register at a fixed rate using the Async Data Output Type Register in the System subsystem. Once configured the data in this register will be sent out with the \$VNGYR header.

9.2.8 Magnetic, Acceleration and Angular Rates

Magnetic, Acceleration, and Angular Rates				
Register ID :	20	Async Header :	MAR	Access : Read Only
Comment :	Magnetic, acceleration, and compensated angular rates.			
Size (Bytes):	36			
Example Response:	\$VNRRG,20,+1.0684,-0.2578,+3.0649,-00.005,+00.341,-09.780,-0.000963,+0.000840,-0.000466*64			
Offset	Name	Format	Unit	Description
0	MagX	float	Gauss	Compensated magnetometer measurement in x-axis.
4	MagY	float	Gauss	Compensated magnetometer measurement in y-axis.
8	MagZ	float	Gauss	Compensated magnetometer measurement in z-axis.
12	AccelX	float	m/s ²	Compensated accelerometer measurement in x-axis.
16	AccelY	float	m/s ²	Compensated accelerometer measurement in y-axis.
20	AccelZ	float	m/s ²	Compensated accelerometer measurement in z-axis.
24	GyroX	float	rad/s	Compensated angular rate in x-axis.
28	GyroY	float	rad/s	Compensated angular rate in y-axis.
32	GyroZ	float	rad/s	Compensated angular rate in z-axis.



You can configure the device to output this register at a fixed rate using the Async Data Output Type Register in the System subsystem. Once configured the data in this register will be sent out with the \$VNMAR header.

9.2.9 Yaw, Pitch, Roll, True Body Acceleration, and Angular Rates

Magnetic, Acceleration, and Angular Rates

Register ID : 239 **Async Header :** YBA **Access :** Read Only
Comment : Attitude solution as yaw, pitch, roll and the inertial acceleration.
Size (Bytes): 36
Example Response: \$VNRRG,239,-124.743,+001.019,-000.203,+00.019,-00.001,+00.039,+00.001665,-
00.000785,+00.000647*55

Offset	Name	Format	Unit	Description
0	Yaw	float	deg	Compensated magnetometer measurement in x-axis.
4	Pitch	float	deg	Compensated magnetometer measurement in y-axis.
8	Roll	float	deg	Compensated magnetometer measurement in z-axis.
12	BodyAccelX	float	m/s ²	Compensated accelerometer measurement in x-axis.
16	BodyAccelY	float	m/s ²	Compensated accelerometer measurement in y-axis.
20	BodyAccelZ	float	m/s ²	Compensated accelerometer measurement in z-axis.
24	GyroX	float	rad/s	Compensated angular rate in x-axis.
28	GyroY	float	rad/s	Compensated angular rate in y-axis.
32	GyroZ	float	rad/s	Compensated angular rate in z-axis.



You can configure the device to output this register at a fixed rate using the Async Data Output Type register (Register 6). Once configured the data in this register will be sent out with the \$VNYBA header.



This register contains the true measured acceleration. The accelerometer measures both acceleration and the effect of static gravity in the body frame. This register contains the true acceleration which does not contain gravity and should measure 0 when the device is stationary.

9.2.10 Magnetic, Acceleration and Angular Rates

Magnetic, Acceleration, and Angular Rates

Register ID : 240 **Async Header :** YIA **Access :** Read Only
Comment : Attitude solution as yaw, pitch, roll and the inertial acceleration.
Size (Bytes): 36
Example Response: \$VNRRG,240,-124.642,+000.993,-000.203,+00.009,-00.027,+00.084,-00.000479,-00.000522,+00.000076*5F

Offset	Name	Format	Unit	Description
0	Yaw	float	deg	Compensated magnetometer measurement in x-axis.
4	Pitch	float	deg	Compensated magnetometer measurement in y-axis.
8	Roll	float	deg	Compensated magnetometer measurement in z-axis.
12	InertialAccelX	float	m/s ²	Compensated accelerometer measurement in x-axis.
16	InertialAccelY	float	m/s ²	Compensated accelerometer measurement in y-axis.
20	InertialAccelZ	float	m/s ²	Compensated accelerometer measurement in z-axis.
24	GyroX	float	rad/s	Compensated angular rate in x-axis.
28	GyroY	float	rad/s	Compensated angular rate in y-axis.
32	GyroZ	float	rad/s	Compensated angular rate in z-axis.



You can configure the device to output this register at a fixed rate using the Async Data Output Type register (Register 6). Once configured the data in this register will be sent out with the \$VNRYA header.



This register contains the true measured acceleration. The accelerometer measures both acceleration and the effect of static gravity in the body frame. This register contains the true acceleration which does not contain gravity and should measure 0 when the device is stationary. The true acceleration provided in this register is measured in the inertial frame. This means that an up/down movement will always appear as an acceleration in the Z-axis on this register regardless of the orientation of the VN-300.

9.3 Configuration Registers

9.3.1 VPE Basic Control

VPE Basic Control				
Register ID :	35	Firmware :	v1.0.0.0	Access : Read / Write
Comment :	Provides control over various features relating to the onboard attitude filtering algorithm.			
Size (Bytes):	4			
Example Response:	\$VNRRG,35,1,1,1,1*75			
Offset	Name	Format	Unit	Description
0	Enable	uint8	-	Enable / Disable the Vector Processing Engine (VPE).
1	HeadingMode	uint8	-	Heading mode used by the VPE.
2	FilteringMode	uint8	-	Filtering Mode used by the VPE.
3	TuningMode	uint8	-	Tuning Mode used by the VPE.

Enable

Value	State
0	DISABLE
1	ENABLE

HeadingMode

Value	Mode
0	Absolute Heading
1	Relative Heading
2	Indoor Heading

Filtering Mode

Value	Mode
0	OFF
1	MODE 1

Tuning Mode

Value	Mode
0	OFF
1	MODE 1

9.4 Factory Defaults

Settings Name	Default Factory Value
VPE Basic Control	1,1,1,1

10 INS Subsystem

10.1 Commands

10.1.1 Set Filter Bias Command

This command will instruct the VN-300 to copy the current filter bias estimates into the Startup Filter Bias Estimate Register in the INS subsystem. After sending this command you will need to issue the write settings command in the System subsystem to save the state of this register to flash memory. Once saved the VN-300 will use these bias estimates as the initial state at startup.

Example Gyro Bias Command

Example Command	Message
UART Command	\$VNSFB*4D
UART Response	\$VNSFB*4D
SPI Command	11 00 00 00 (shown in hex)
SPI Response	00 11 00 00 (shown in hex)

10.2 Measurement Registers

10.2.1 INS Solution – LLA

INS Solution - LLA				
Register ID :	63	Async Header :	INS	Access : Read Only
Comment :	Estimated INS Solution with lat/lon/alt position			
Size (Bytes):	72			
Example Response:	\$VNRRG,63,333811.902862,1694,0004,+009.500,-004.754,-000.225,+32.95602815,-096.71424297,+00171.195,-000.840,-000.396,-000.109,07.8,01.6,0.23*5F			
Offset	Name	Format	Unit	Description
0	Time	double	sec	GPS time of week in seconds.
8	Week	uint16	week	GPS week.
10	Status	uint16	-	Status flags for INS filter. Hexadecimal format. See table below.
12	Yaw	float	deg	Yaw angle relative to true north (Range: +/- 180°).
16	Pitch	float	deg	Pitch angle relative to horizon (Range: +/- 90°).
20	Roll	float	deg	Roll angle relative to horizon (Range: +/- 180°).
24	Latitude	double	deg	INS solution position in geodetic latitude.
32	Longitude	double	deg	INS solution position in geodetic longitude.
40	Altitude	double	m	Height above ellipsoid. (WGS84)
48	NedVelX	float	m/s	INS solution velocity in NED frame. (North)
52	NedVelY	float	m/s	INS solution velocity in NED frame. (East)
56	NedVelZ	float	m/s	INS solution velocity in NED frame. (Down)
60	AttUncertainty	float	deg	Uncertainty in attitude estimate.
64	PosUncertainty	float	m	Uncertainty in position estimate.
68	VelUncertainty	float	m/s	Uncertainty in velocity estimate.

INS Status			
Name	Bit Offset	Format	Description
Mode	0	2 bits	Indicates the current mode of the INS filter. 0 = Not tracking. GNSS Compass is initializing. Output heading is based on magnetometer measurements. 1 = Aligning. INS Filter is dynamically aligning. For a stationary startup: GNSS Compass has initialized and INS Filter is aligning from the magnetic heading to the GNSS Compass heading. For a dynamic startup: INS Filter has initialized and is dynamically aligning to True North heading. In operation, if the INS Filter drops from INS Mode 2 back down to 1, the attitude uncertainty has increased above 2 degrees. 2 = Tracking. The INS Filter is tracking and operating within specification. 3 = Loss of GNSS. A GNSS outage has lasted more than 45 seconds. The INS Filter will no longer update the position and velocity outputs, but the attitude remains valid.
GNSSFix	2	1 bit	Indicates whether the GNSS has a proper fix.
Error	3	4 bits	Sensor measurement error code. See table below. 0 = No errors detected.
Reserved	7	1 bit	Reserved for internal use. May toggle state during runtime and should be ignored.
GNSSHeadingIns	8	1 bit	In stationary operation, if set the INS Filter has fully aligned to the GNSS Compass solution. In dynamic operation, the GNSS Compass solution is currently aiding the INS Filter heading solution.
GNSSCompass	9	1 bit	Indicates if the GNSS compass is operational and reporting a heading solution.
Reserved	10	6 bits	Reserved for internal use. These bits will toggle state and should be ignored.

Error Bitfield

Name	Bit Offset	Format	Description
Reserved	0	1 bit	Reserved for future use and not currently used.
IMU Error	1	1 bit	High if IMU communication error is detected.
Mag/Pres Error	2	1 bit	High if Magnetometer or Pressure sensor error is detected.
GNSS Error	3	1 bit	High if GNSS communication error is detected.



You can configure the device to output this register at a fixed rate using the Async Data Output Type Register in the System subsystem. Once configured the data in this register will be sent out with the \$VNINS header.

10.2.2 INS Solution - ECEF

INS Solution – ECEF				
Register ID :	64	Async Header :	INE	Access : Read Only
Comment :	Estimated INS Solution with ECEF position			
Size (Bytes):	72			
Example Response:	\$VNRRG,64,333837.222917,1694,0004,+009.315,-004.767,-000.193,-0626356.433,-5320530.947,+3449961.679,-000.224,-000.476,-000.564,07.7,01.5,0.22*65			
Offset	Name	Format	Unit	Description
0	Time	double	sec	GPS time of week in seconds.
8	Week	uint16	week	GPS week.
10	Status	uint16	-	Status flags for INS filter. See table below.
12	Yaw	float	deg	Yaw angle relative to true north (Range: +/- 180°).
16	Pitch	float	deg	Pitch angle relative to horizon (Range: +/- 90°).
20	Roll	float	deg	Roll angle relative to horizon (Range: +/- 180°).
24	PositionX	double	m	INS solution position in ECEF. (X-axis)
32	PositionY	double	m	INS solution position in ECEF. (Y-axis)
40	PositionZ	double	m	INS solution position in ECEF. (Z-axis)
48	VelocityX	float	m/s	INS solution velocity in ECEF frame. (X-axis)
52	VelocityY	float	m/s	INS solution velocity in ECEF frame. (Y-axis)
56	VelocityZ	float	m/s	INS solution velocity in ECEF frame. (Z-axis)
60	AttUncertainty	float	deg	Expected uncertainty in estimated attitude.
64	PosUncertainty	float	m	Expected uncertainty in estimated position.
68	VelUncertainty	float	m/s	Expected uncertainty in estimated velocity.

INS Status

Name	Bit Offset	Format	Description
Mode	0	2 bits	Indicates the current mode of the INS filter. 0 = Not tracking. GNSS Compass is initializing. Output heading is based on magnetometer measurements. 1 = Aligning. INS Filter is dynamically aligning. For a stationary startup: GNSS Compass has initialized and INS Filter is aligning from the magnetic heading to the GNSS Compass heading. For a dynamic startup: INS Filter has initialized and is dynamically aligning to True North heading. In operation, if the INS Filter drops from INS Mode 2 back down to 1, the attitude uncertainty has increased above 2 degrees. 2 = Tracking. The INS Filter is tracking and operating within specification. 3 = Loss of GNSS. A GNSS outage has lasted more than 45 seconds. The INS Filter will no longer update the position and velocity outputs, but the attitude remains valid.
GNSSFix	2	1 bit	Indicates whether the GNSS has a proper fix.
Error	3	4 bits	Sensor measurement error code. See table below. 0 = No errors detected.
Reserved	7	1 bit	Reserved for internal use. May toggle state during runtime and should be ignored.
GNSSHeadingIns	8	1 bit	In stationary operation, if set the INS Filter has fully aligned to the GNSS Compass solution. In dynamic operation, the GNSS Compass solution is currently aiding the INS Filter heading solution.
GNSSCompass	9	1 bit	Indicates if the GNSS compass is operational and reporting a heading solution.
Reserved	10	6 bits	Reserved for internal use. These bits will toggle state and should be ignored.

Error Bitfield

Name	Bit Offset	Format	Description
Reserved	0	1 bit	Reserved for future use and not currently used.
IMU Error	1	1 bit	High if IMU communication error is detected.
Mag/Pres Error	2	1 bit	High if Magnetometer or Pressure sensor error is detected.
GNSS Error	3	1 bit	High if GNSS communication error is detected.



You can configure the device to output this register at a fixed rate using the Async Data Output Type Register in the System subsystem. Once configured the data in this register will be sent out with the \$VNINE header.

10.2.3 INS State - LLA

INS State – LLA				
Register ID :	72	Async Header :	ISL	Access : Read Only
Comment :	Estimated INS State with latitude, longitude, altitude			
Size (Bytes):	80			
Example Response:	\$VNRRG,72,+170.420,+001.398,+001.806,+00.000295,-00.000911,-00.000905,+32.95680804,-096.71414860,+00179.592,+000.181,-000.073,-000.050,+00.209,-00.322,-10.040*52			
Offset	Name	Format	Unit	Description
0	Yaw	float	deg	Yaw angle relative to true north (Range: +/- 180°).
4	Pitch	float	deg	Pitch angle relative to horizon (Range: +/- 90°).
8	Roll	float	deg	Roll angle relative to horizon (Range: +/- 180°).
12	-	-	-	--- 4 PADDING BYTES ---
16	Latitude	double	deg	Estimated position in geodetic latitude.
24	Longitude	double	deg	Estimated position in geodetic longitude.
32	Altitude	double	m	Estimated height above ellipsoid. (WGS84)
40	VelocityX	float	m/s	Estimated velocity in NED frame. (North)
44	VelocityY	float	m/s	Estimated velocity in NED frame. (East)
48	VelocityZ	float	m/s	Estimated velocity in NED frame. (Down)
52	AccelX	float	m/s ²	Estimated acceleration in body frame. (X-axis)
56	AccelY	float	m/s ²	Estimated acceleration in body frame. (Y-axis)
60	AccelZ	float	m/s ²	Estimated acceleration in body frame. (Z-axis)
64	AngularRateX	float	rad/s	Estimated angular rate in body frame. (X-axis)
68	AngularRateY	float	rad/s	Estimated angular rate in body frame. (Y-axis)
72	AngularRateZ	float	rad/s	Estimated angular rate in body frame. (Z-axis)



You can configure the device to output this register at a fixed rate using the Async Data Output Type Register in the System subsystem. Once configured the data in this register will be sent out with the \$VNISL header.

10.2.4 INS State - ECEF

INS State – ECEF				
Register ID :	73	Async Header :	ISE	Access : Read Only
Comment :	Estimated INS Solution with ECEF position			
Size (Bytes):	80			
Example Read	\$VNRRG,73,+170.558,+001.267,+001.762,+00.001502,-00.000403,+00.000394,-			
Response:	626343.88590823,-5320499.92650050,+3450022.606,+000.001,- 000.010,+000.094,+00.255,-00.308,-10.060*50			
Example Async	\$VNISE,+170.558,+001.267,+001.762,+00.001502,-00.000403,+00.000394,-			
Message:	626343.88590823,-5320499.92650050,+3450022.606,+000.001,- 000.010,+000.094,+00.255,-00.308,-10.060*XX			
Offset	Name	Format	Unit	Description
0	Yaw	float	deg	Yaw angle relative to true north (Range: +/- 180°).
4	Pitch	float	deg	Pitch angle relative to horizon (Range: +/- 90°).
8	Roll	float	deg	Roll angle relative to horizon (Range: +/- 180°).
12	-	-	-	--- 4 PADDING BYTES ---
16	PositionX	double	m	Estimated position in ECEF. (X-axis)
24	PositionY	double	m	Estimated position in ECEF. (Y-axis)
32	PositionZ	double	m	Estimated position in ECEF. (Z-axis)
40	VelocityX	float	m/s	Estimated velocity in ECEF frame. (X-axis)
44	VelocityY	float	m/s	Estimated velocity in ECEF frame. (Y-axis)
48	VelocityZ	float	m/s	Estimated velocity in ECEF frame. (Z-axis)
52	AccelX	float	m/s ²	Estimated acceleration in body frame. (X-axis)
56	AccelY	float	m/s ²	Estimated acceleration in body frame. (Y-axis)
60	AccelZ	float	m/s ²	Estimated acceleration in body frame. (Z-axis)
64	AngularRateX	float	rad/s	Estimated angular rate in body frame. (X-axis)
68	AngularRateY	float	rad/s	Estimated angular rate in body frame. (Y-axis)
72	AngularRateZ	float	rad/s	Estimated angular rate in body frame. (Z-axis)



You can configure the device to output this register at a fixed rate using the Async Data Output Type Register in the System subsystem. Once configured the data in this register will be sent out with the \$VNISE header.

10.3 Configuration Registers

10.3.1 INS Basic Configuration

INS Basic Configuration				
Register ID :		67	Access : Read / Write	
Comment :				
Size (Bytes):		4		
Example Response:		\$VNRRG,67,3,1,1,0*71		
Offset	Name	Format	Unit	Description
0	Scenario	uint8	-	INS mode. 1 = General purpose INS with barometric pressure sensor. 2 = General purpose INS without barometric pressure sensor. 3 = GNSS moving baseline for dynamic applications.
1	AhrsAiding	uint8	-	Enables AHRS attitude aiding. AHRS aiding provides the ability to switch to using the magnetometer to stabilize heading during times when the device is stationary and the GNSS compass is not available. AHRS aiding also helps to eliminate large updates in the attitude solution during times when heading is weakly observable, such as at startup. 0 = AHRS aiding is disabled. 1 = AHRS aiding is enabled.
2	EstBaseline	uint8	-	Enables GNSS compass baseline estimation by INS. 0 = Baseline estimation is disabled. 1 = Baseline estimation is enabled.
3	Resv2	uint8	-	Reserved for future use. Field should be set to zero.

10.3.2 Startup Filter Bias Estimate

Startup Filter Bias Estimate				
Register ID :	74			Access : Read / Write
Comment :	Sets the initial estimate for the filter bias states.			
Size (Bytes):	28			
Example Command:	\$ VNWRG,74,0,0,0,0,0,0,0*69			
Offset	Name	Format	Unit	Description
0	GyroBiasX	float	rad/s	X-axis gyro bias.
4	GyroBiasY	float	rad/s	Y-axis gyro bias.
8	GyroBiasZ	float	rad/s	Z-axis gyro bias.
12	AccelBiasX	float	m/s ²	X-axis accelerometer bias.
16	AccelBiasY	float	m/s ²	Y-axis accelerometer bias.
20	AccelBiasZ	float	m/s ²	Z-axis accelerometer bias.
24	PressureBias	float	m	Pressure bias.

10.4 Factory Defaults

Settings Name	Default Factory Value
INS Basic Configuration	3,0,1,0
Startup Filter Bias Estimate	0,0,0,0,0,0

11 Hard/Soft Iron Estimator Subsystem

11.1 Configuration Registers

11.1.1 Magnetometer Calibration Control

Magnetometer Calibration Control				
Register ID :	44			Access : Read / Write
Comment :	Controls the magnetometer real-time calibration algorithm.			
Size (Bytes):	4			
Example Response:	\$VNRRG,44,1,2,5*69			
Offset	Name	Format	Unit	Description
0	HSIMode	uint8	-	Controls the mode of operation for the onboard real-time magnetometer hard/soft iron compensation algorithm.
1	HSIOutput	uint8	-	Controls the type of measurements that are provided as outputs from the magnetometer sensor and also subsequently used in the attitude filter.
2	ConvergeRate	uint8	-	Controls how quickly the hard/soft iron solution is allowed to converge onto a new solution. The slower the convergence the more accurate the estimate of the hard/soft iron solution. A quicker convergence will provide a less accurate estimate of the hard/soft iron parameters, but for applications where the hard/soft iron changes rapidly may provide a more accurate attitude estimate. Range: 1 to 5 1 = Solution converges slowly over approximately 60-90 seconds. 5 = Solution converges rapidly over approximately 15-20 seconds.

Table 23 – HSI_Mode Field

Mode	Value	Description
HSI_OFF	0	Real-time hard/soft iron calibration algorithm is turned off.
HSI_RUN	1	Runs the real-time hard/soft iron calibration. The algorithm will continue using its existing solution. The algorithm can be started and stopped at any time by switching between the HSI_OFF and HSI_RUN state.
HSI_RESET	2	Resets the real-time hard/soft iron solution.

Table 24 – HSI_Output Field

Mode	Value	Description
NO_ONBOARD	1	Onboard HSI is not applied to the magnetic measurements.
USE_ONBOARD	3	Onboard HSI is applied to the magnetic measurements.



On the PRODUCT the magnetometer is only used to provide a coarse heading estimate at startup and is completely tuned out of the INS filter during normal operation. A Hard/Soft Iron calibration may be performed to try and improve the startup magnetic heading, but is not required for nominal operation.

11.2 Status Registers

11.2.1 Calculated Magnetometer Calibration

Calculated Magnetometer Calibration				
Register ID :	47			Access : Read Only
Comment :	Calculated magnetometer calibration values.			
Size (Bytes):	48			
Example Response:	\$VNRRG,46,1,0,0,0,1,0,0,0,1,0,0,0*70			
Offset	Name	Format	Unit	Description
0	C[0,0]	float	-	
4	C[0,1]	float	-	
8	C[0,2]	float	-	
12	C[1,0]	float	-	
16	C[1,1]	float	-	
20	C[1,2]	float	-	
24	C[2,0]	float	-	
28	C[2,1]	float	-	
32	C[2,2]	float	-	
36	B[0]	float	-	
40	B[1]	float	-	
44	B[2]	float	-	

This register contains twelve values representing the calculated hard and soft iron compensation parameters. The magnetic measurements are compensated for both hard and soft iron using the following model.

$$\begin{Bmatrix} X \\ Y \\ Z \end{Bmatrix} = \begin{bmatrix} C00 & C01 & C02 \\ C10 & C11 & C12 \\ C20 & C21 & C22 \end{bmatrix} \cdot \begin{Bmatrix} MX - B0 \\ MY - B1 \\ MZ - B2 \end{Bmatrix}$$

The variables $\{MX, MY, MZ\}$ are components of the measured magnetic field. The $\{X, Y, Z\}$ variables are the new magnetic field measurements outputted after compensation for hard/soft iron effects.

11.3 Factory Defaults

Settings Name	Default Factory Value
Magnetometer Calibration Control	1,3,5

11.4 Command Prompt

The command prompt provides a fast and simple means of configuring and monitoring the status of the sensor by typing commands to the unit using the serial port.

11.4.1 List Available Commands

Commands for the System subsystem can be accessed by typing in 'hsi' at the command prompt. To view all available commands, type 'hsi ?'. Below is a view of a terminal window showing a list of the available commands.

```
hsi ?  
  
Hard/Soft Iron Estimator Module Commands:  
  
Command:      Description:  
-----  
info          Estimator state information and configuration settings.  
plotInput     Plot onboard HSI Input.  
plotOutput    Plot onboard HSI Output.
```

11.4.2 Info

```
hsi info  
----- Hard/Soft Iron Estimator State Information -----  
Magnetometer Calibration Control (Register 44):  
  
HsiMode: Run  
OutMode: Use Onboard  
ConvergeRate: 5  
  
Magnetometer Calibration Status (Register 46):  
  
LastBin: 0  
NumMeas: 102  
AvgResidual: 0.014  
LastMeas: +0.599 +0.538 +2.910  
Bins[0]: 215  
Bins[1]: 188  
Bins[2]: 135  
Bins[3]: 47  
Bins[4]: 198  
Bins[5]: 231  
Bins[6]: 202  
  
Calculated Magnetometer Calibration (Register 47):  
  
+00.966 +00.000 +00.000 -00.215  
+00.000 +00.966 +00.000 -00.179  
+00.000 +00.000 +00.966 -00.077  
  
Num Measurements: 358  
Filter Run Count: 358  
Mag Uncertainty : 0.00  
-----
```

11.4.3 PlotInput

hsi plotinput

----- HSI Estimator Magnetic Input Plot -----

Uncalibrated XY

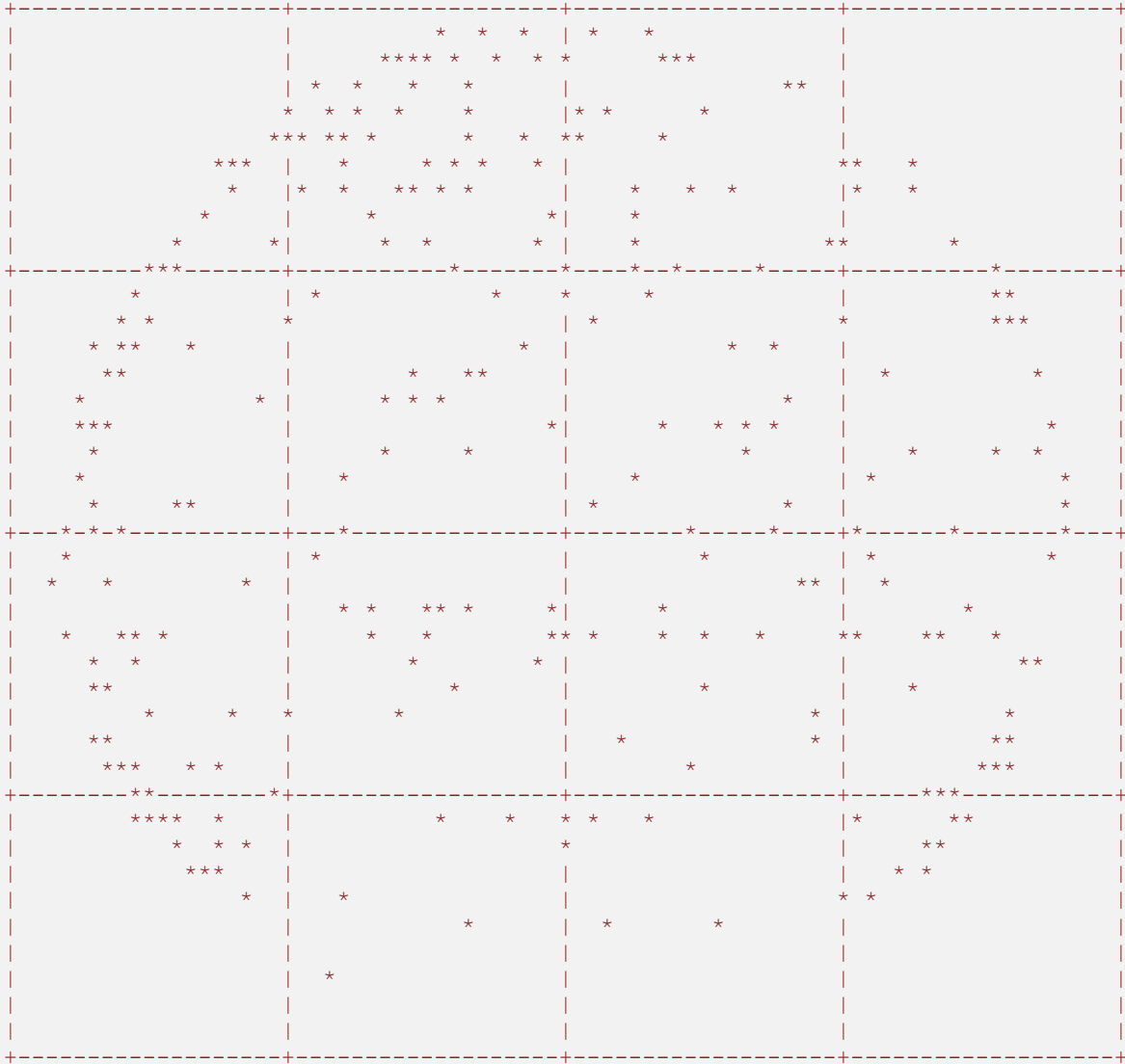

Plot Center : +0.000, +0.000
Plot Scale : +1.042, +1.042

11.4.4 PlotOutput

hsi plotoutput

----- HSI Estimator Magnetic Output Plot -----

Calibrated XY

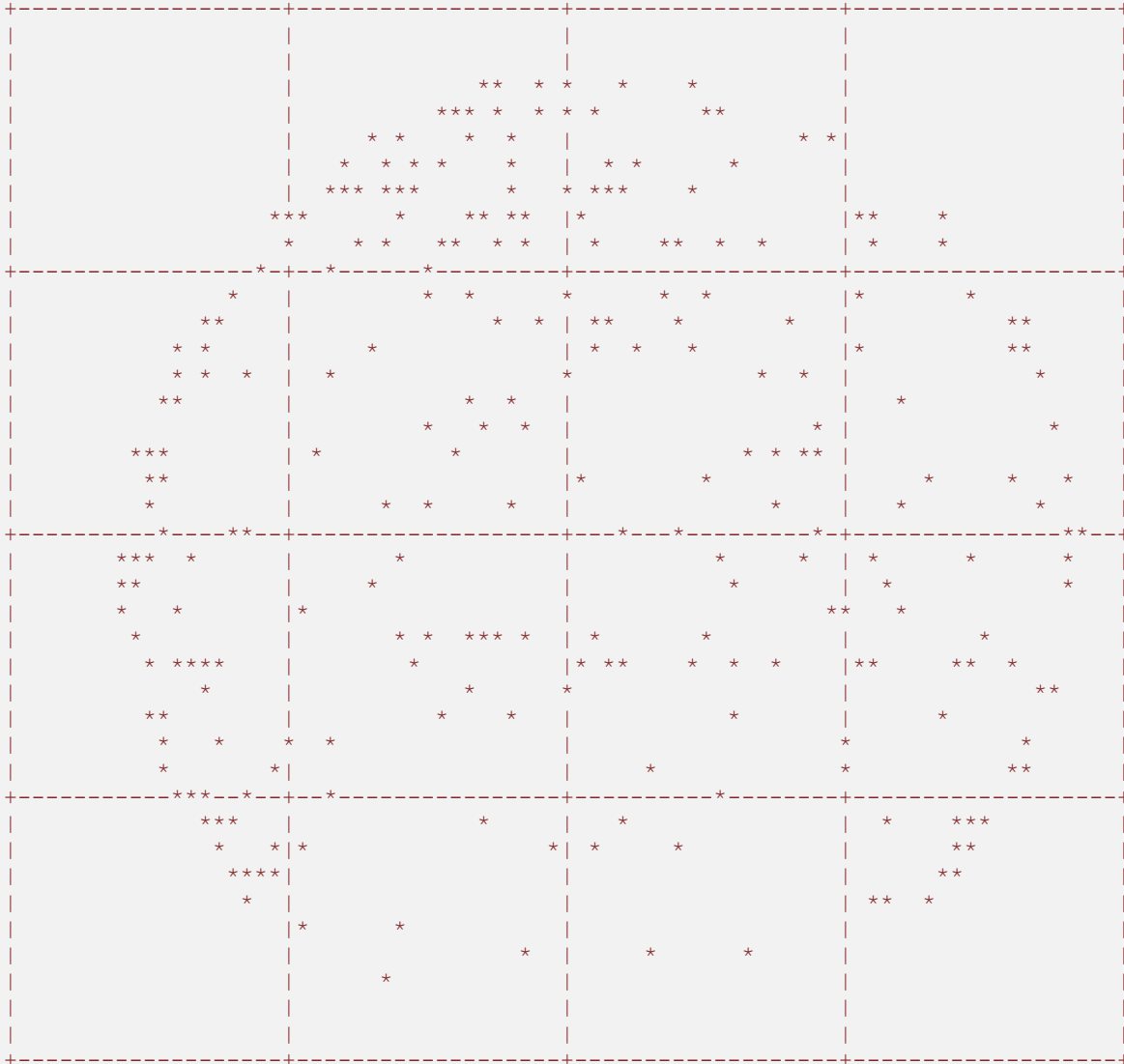

Plot Center : +0.000, +0.000
Plot Scale : +0.946, +0.946

12 World Magnetic & Gravity Module

12.1 Configuration Registers

12.1.1 Magnetic and Gravity Reference Vectors

Magnetic and Gravity Reference Vectors				
Register ID :	21	Firmware :	0.3.0.0	Access: Read / Write
Comment :	Magnetic and gravity reference vectors.			
Size (Bytes):	24			
Example Command:	\$VNWRG,21,1,0,1.8,0,0,-9.79375*56			
Offset	Name	Format	Unit	Description
0	MagRefX	float	Gauss	X-Axis Magnetic Reference
4	MagRefY	float	Gauss	Y-Axis Magnetic Reference
8	MagRefZ	float	Gauss	Z-Axis Magnetic Reference
12	AccRefX	float	m/s ²	X-Axis Gravity Reference
16	AccRefY	float	m/s ²	Y-Axis Gravity Reference
20	AccRefZ	float	m/s ²	Z-Axis Gravity Reference

This register contains the reference vectors for the magnetic and gravitational fields as used by the onboard filter. The values map to either the user-set values or the results of calculations of the onboard reference models (see the Reference Vector Configuration Register in the IMU subsystem). When the reference values come from the onboard model(s), those values are read-only. When the reference models are disabled, the values reflect the user reference vectors and will be writable. For example, if the onboard World Magnetic Model is enabled and the onboard Gravitational Model is disabled, only the gravity reference values will be modified on a register write. Note that the user reference vectors will not be overwritten by the onboard models, but will retain their previous values for when the onboard models are disabled.

12.1.2 Reference Vector Configuration

Reference Vector Configuration				
Register ID :	83	Firmware :	v0.3.0.0	Access : Read / Write
Comment :	Control register for both the onboard world magnetic and gravity model corrections.			
Size (Bytes):	32			
Example Response:	\$VNRRG,83,0,0,0,0,1000,0.000,+00.00000000,+000.00000000,+00000.000*4E			
Offset	Name	Format	Unit	Description
0	UseMagModel	uint8	-	Set to 1 to use the world magnetic model.
1	UseGravityModel	uint8	-	Set to 1 to use the world gravity model.
2	Resv	uint8	-	Reserved for future use. Must be set to zero.
3	Resv	uint8	-	Reserved for future use. Must be set to zero.
4	RecalcThreshold	uint32	-	Maximum distance traveled before magnetic and gravity models are recalculated for the new position.
8	Year	float	year	The reference date expressed as a decimal year. Used for both the magnetic and gravity models.
12				**** 4 byte padding ***
16	Latitude	double	deg	The reference latitude position in degrees.
24	Longitude	double	deg	The reference longitude position in degrees.
32	Altitude	double	m	The reference altitude above the reference ellipsoid in meters.

This register allows configuration of the onboard spherical harmonic models used to calculate the local magnetic and gravitational reference values. Having accurate magnetic reference values improves the accuracy of heading when using the magnetometer and accounts for magnetic declination. Having accurate gravitational reference values improves accuracy by allowing the INS filter to more accurately estimate the accelerometer biases. The VN-300 currently includes the EGM96 gravitational model and the WMM2010 magnetic model. The models are upgradable to allow updating to future models when available.

The magnetic and gravity models can be individually enabled or disabled using the UseMagModel and UseGravityModel parameters, respectively. When disabled, the corresponding values set by the user in the Reference Vector Register in the IMU subsystem will be used instead of values calculated by the onboard model.

The VN-300 starts up with the user configured reference vector values. Shortly after startup (and if the models are enabled), the location and time set in this register will be used to update the reference vectors. When a 3D GNSS fix is available, the location and time reported by the GNSS will be used to update the model. If GNSS is lost, the reference vectors will hold their last valid values. The model values will be recalculated whenever the current position has changed by the RecalcThreshold or the date has changed by more than approximately 8 hours, whichever comes first.

12.2 Factory Defaults

Settings Name	Default Factory Value
Magnetic and Gravity Reference Vectors	1,0,1.8,0,0,-9.793746
Reference Vector Configuration	1,1,0,0,10,0,0,0,0

12.3 Command Prompt

The command prompt provides a fast and simple means of configuring and monitoring the status of the sensor by typing commands to the unit using the serial port.

12.3.1 List Available Commands

Commands for the System subsystem can be accessed by typing in 'refmodel' at the command prompt. To view all available commands, type 'refmodel?'. Below is a view of a terminal window showing a list of the available commands.

```
refmodel ?

World Magnetic & Gravity Reference Model Commands:

Command:      Description:
-----      -
info          Information on the current available reference models.
calc          Calculate the magnetic and gravity reference for a given position &
time.
```

12.3.2 Info

```
refmodel info

----- World Magnetic & Gravity Reference Model Information -----

World Magnetic Model
  Status           : Present
  Name             : WMM2010
  Order            : 12
  Model Start Date : 01/01/2010
  Model Expiration Date : 01/01/2015

World Gravity Model
  Status           : Present
  Name             : EGM96
  Order            : 12
  Model Start Date : 01/01/1986
  Model Expiration Date : 01/01/2100

Magnetic and Gravity Reference Vectors (Register 21)
  MagRefX          : +001.000
  MagRefY          : +000.000
  MagRefZ          : +001.800
  GravityRefX     : +000.000
  GravityRefY     : +000.000
  GravityRefZ     : -009.794

Reference Vector Configuration (Register 83)
  UseMagneticModel : 0
  UseGravityModel  : 0
  RecalcThreshold  : 1000 meters
  Year             : 0
  Latitude         : +00.00000000 deg
  Longitude        : +00.00000000 deg
  Altitude         : +00000.000 m
-----
```

Please Read Carefully:

Information in this document is provided solely in connection with VectorNav Technologies, LLC (“VectorNav”) products. VectorNav reserves the right to make changes, corrections, modifications, or improvements to this document, and the products and services described herein at any time, without notice.

All VectorNav products are sold pursuant of VectorNav’s terms and conditions of sale.

No license to any intellectual property, expressed or implied, is granted under this document. If any part of this document refers to any third party products or services it shall not be deemed a license grant by VectorNav for the use of such third party products or services, or any intellectual property contained therein or considered as a warranty covering the use in any manner whatsoever of such third party products or services or any intellectual property contained therein.

Information in this document supersedes and replaces all information previously supplied.

The VectorNav logo is a registered trademark of VectorNav Technologies, LLC. All other names are the property of their respective owners.

© 2017 VectorNav Technologies, LLC – All rights reserved