



SEA-BIRD
SCIENTIFIC

User Manual

Release Date: 09/08/2020

SBE Sea-Bird
Electronics

GPCTD Glider Payload CTD (optional DO)

Conductivity, Temperature, and Pressure (optional DO)
Sensor with RS-232 Interface



GPCTD & pump



Optional SBE 43F
DO Sensor

Manual version
Firmware version
Software versions

- 007
- 1.2.1 & later
- Seaterm V2 2.6.1 & later
- SBE Data Processing 7.26.1 & later

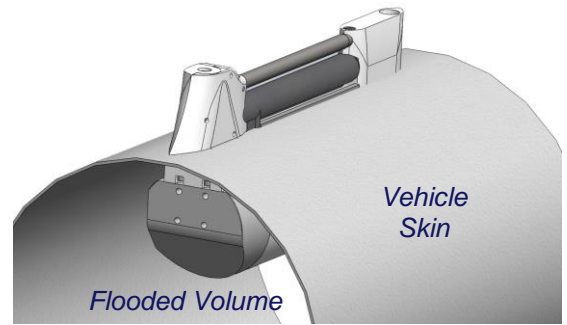

Vehicle
Skin

Flooded Volume

Sea-Bird Electronics
13431 NE 20th Street
Bellevue, Washington
98005 USA

Tel: +1 425-643-9866
seabird@seabird.com
www.seabird.com

Limited Liability Statement

Extreme care should be exercised when using or servicing this equipment. It should be used or serviced only by personnel with knowledge of and training in the use and maintenance of oceanographic electronic equipment.

SEA-BIRD ELECTRONICS, INC. disclaims all product liability risks arising from the use or servicing of this system. SEA-BIRD ELECTRONICS, INC. has no way of controlling the use of this equipment or of choosing the personnel to operate it, and therefore cannot take steps to comply with laws pertaining to product liability, including laws which impose a duty to warn the user of any dangers involved in operating this equipment. Therefore, acceptance of this system by the customer shall be conclusively deemed to include a covenant by the customer to defend, indemnify, and hold SEA-BIRD ELECTRONICS, INC. harmless from all product liability claims arising from the use or servicing of this system.

Declaration of Conformity

Sea-Bird Electronics, Inc.
13431 NE 20th Street Bellevue, WA 98005

DECLARATION OF CONFORMITY

Manufacturer's Name: Sea-Bird Electronics

Manufacturer's Address: 13431 NE 20th Street
Bellevue, WA 98005, USA

Device Description: Various Data Acquisition Devices and Sensors

Model Numbers:

3S	3F	3plus	4C	4M	5M	5T
5P	7	8	9plus	11plusV2	14	16plusV2
16plusIM-V2	17plusV2	18	19plusV2	21	25plus	26plus
27	29	32	32C	32SC	33	35
35RT	36/PDIM	37-SI	37-SIP	37-IM	37-IMP	37-SM
37-SMP	38	39	39-IM	39plus	41	41CP
43	43F	44	45	48	49	50
52-MP	53	54	55	56	63	PN 90204
PN 90158.1	PN 90488	PN 90545	PN 90402	AFM	SIM	ICC
IMM/UIMM	Glider Payload CTD	NIMH Battery Charger & Battery Pack (PN 90504)				

Applicable EU Directives: Machinery Directive 2006/42/EC

EMC Directive 2004/108/EC

Low Voltage Directive (2006/95/EC)

Applicable Harmonized Standards:

EN 61326-1:2013 Class A Electrical Equipment for Measurement, Control and Laboratory Use, EMC Requirement - Part 1: General Requirements (EN 55011:2009 Group 1, Class A)

EN 61010-1:2010, Safety Requirements for Electrical Equipments for Measurement, Control, and Laboratory Use - Part 1: General Requirements

I, the undersigned, hereby declare that the equipment specified above conforms to the above European Union Directives and Standards.

Authorized Signature:	
Name:	Casey Moore
Title of Signatory:	President
Date:	June 6, 2014
Place:	Bellevue, WA

Table of Contents

Limited Liability Statement	2
Declaration of Conformity	3
Table of Contents	4
Section 1: Introduction	6
About this Manual	6
Quick Start	6
Unpacking GPCTD	7
Section 2: Description of GPCTD	8
System Description	8
Specifications	11
Dimensions and Connectors	12
Cables and Wiring	13
Data I/O	14
Data Storage	15
Sample Timing	15
Section 3: Power and Communications Test	16
Software Installation	16
Test Setup	16
Test	17
Section 4: Deploying and Operating GPCTD	22
Sampling Modes	22
Autonomous Sampling	23
Spot Sampling	25
Command Descriptions	26
Data Formats	42
OutputFormat=0 (engineering units in Hex)	42
OutputFormat=1 (engineering units in Decimal)	42
OutputFormat=2 (raw data in Decimal)	43
Optimizing Data Quality	44
Deployment/Recovery Technique and Pump Operation	44
Deployment	45
Recovery	46
Uploading and Processing Data	47
Section 5: Routine Maintenance and Calibration	51
Corrosion Precautions	51
Connector Mating and Maintenance	51
Conductivity Cell Maintenance	52
Pressure Sensor Maintenance	52
Oxygen Sensor Maintenance	52
Replacing Anti-Foulant Devices – Mechanical Design Change	53
Replacing Anti-Foulant Devices (SBE 37-SI, SM, IM)	54
Sensor Calibration	55
Conductivity Sensor Calibration	55
Temperature Sensor Calibration	55
Pressure Sensor Calibration	55
Oxygen Sensor Calibration	56
Section 6: Troubleshooting	57
Problem 1: Unable to Communicate with GPCTD	57
Problem 2: Unreasonable Data	57
Problem 3: Salinity Lower than Expected	57

Glossary	58
Appendix I: Functional Description and Circuitry.....	59
Sensors and Sensor Interface	59
Memory.....	59
Appendix II: Command Summary.....	60
Appendix III: AF24173 Anti-Foulant Device	62
Appendix IV: Replacement Parts.....	66
Appendix V: Manual Revision History	67
Index.....	68

Section 1: Introduction

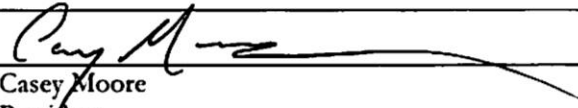
This section includes contact information, Quick Start procedure, and photos of a typical Glider Payload CTD (GPCTD) shipment.

About this Manual

This manual is to be used with the Glider Payload CTD (GPCTD) and DO Sensor. It is organized to guide the user from installation through operation and data collection. We've included detailed specifications, command descriptions, maintenance and calibration information, and helpful notes throughout the manual.

Sea-Bird welcomes suggestions for new features and enhancements of our products and/or documentation. Please contact us with any comments or suggestions (seabird@seabird.com or 425-643-9866). Our business hours are Monday through Friday, 0800 to 1700 Pacific Standard Time (1600 to 0100 Universal Time) in winter and 0800 to 1700 Pacific Daylight Time (1500 to 0000 Universal Time) the rest of the year.

Quick Start

Follow these steps to get a Quick Start using the GPCTD. The manual provides step-by-step details for performing each task:

1. Test power and communications (*Section 3: Power and Communications Test*). Establish setup and sampling parameters, including **Interval** for autonomous sampling.
2. Deploy the GPCTD (*Section 4: Deploying and Operating GPCTD*):
 - A. Install I/O cable connector and locking sleeve. Connect other end of cable to glider controller and power supply.
 - B. Verify hardware and external fittings are secure.
 - C. Remove caps from end of T-C Duct intake and pump exhaust.
 - D. Deploy GPCTD.
 - E. With GPCTD in water and below the surface (to avoid running the pump *dry* and to avoid ingesting dirty surface water),
 - For autonomous sampling if **AutoRun=N**: Apply power. Send any character to wake up GPCTD. Then send **Start** to start pump and start sampling at user-input **Interval**.
 - For autonomous sampling if **AutoRun=Y**: Apply power to start pump and start sampling at user-input **Interval**.

Note:

The I/O cable is **not** included as part of the typical shipment, and must be ordered separately.

Unpacking GPCTD

Shown below is a typical GPCTD shipment.



GPCTD and pump in
1500 m titanium housing
(optional Dissolved Oxygen Sensor not shown)

Cable (not shown):
GPCTD to pump



Software, and Electronic Copies of
Software Manuals and User Manual

Section 2: Description of GPCTD

This section describes the functions and features of the Glider Payload CTD and Optional DO Sensor, including specifications, dimensions, connectors, communications, memory, and sample timing.

System Description



GPCTD with pump
(shown with 1500 m titanium housing)



Optional SBE 43F
Dissolved Oxygen Sensor

The Glider Payload CTD (GPCTD) measures conductivity, temperature, and pressure, and optionally, dissolved oxygen (with the modular SBE 43F DO sensor). It is a modular, low-power profiling instrument for autonomous gliders with the high accuracy necessary for research, inter-comparison with moored observatory sensors, updating circulation models, and leveraging data collection opportunities from operational vehicle missions. The pressure-proof module allows glider users to exchange CTDs (and DO sensors) in the field without opening the glider pressure hull.

The GPCTD evolved from sensors and measurement methods used in Argo float CTDs. Their performance and reliability has been proven on more than 8,000 Argo floats to date. The constant pumped flow and ducted T & C sensors provide superior dynamic accuracy compared to free-flushed sensors. However, TS errors introduced by glider flight dynamics, boundary layers, and wakes are larger than those experienced by vertically ascending Argo floats, reducing the achievable dynamic accuracy on gliders.

Improvements in efficiency have yielded a continuously pumped CTD that consumes only 175 mw while recording at 1 Hz, or 190 mw when transmitting real-time data. To put this in perspective, the energy contained in one Alkaline D cell will operate the CTD continuously for 114 hours, or 9.5 days at 50% duty cycle (profiling continuously at 1 Hz on every glider upcast). One Lithium DD cell will provide 48 days profiling continuously on every upcast.

The T-C sensor assembly visible on the exterior of the vehicle consists of a streamlined T-C intake sail (with integral T-C duct and anti-foul device), a horizontal, internal field conductivity cell, and a downstream exhaust sail with pump connections. The intake sail allows measurements to be made outside of the vehicle's boundary flow where *old* water is thermally contaminated by the vehicle, producing TS errors. The pump pulls water into the duct at top of the intake sail and immediately past a temperature sensor. Water then flows through an anti-foulant cylinder, through the conductivity cell, and out the top of the exhaust sail to prevent exhaust re-circulation and Bernoulli pressure differences from changing the flow rate. The outside of the conductivity cell is free-flushed to minimize salinity errors. If the cell were located inside the flooded fairing, a *thermal mass* error resulting from temperature difference between the poorly-flushed volume inside the hull and the ambient ocean temperature measured by the CTD would produce salinity errors.

The connecting *neck*, electronics housing, modular pump, and DO sensor are meant to locate in a flooded space inside the glider hull. Pump tubing between the conductivity cell and the pump intake, and from the pump outlet to the exhaust fitting on the sail, are not shown. The locations of the pump and DO sensor within the flooded volume are not pre-determined, but tubing lengths should be as short as possible and avoid sharp bends, and the pump (centrifugal impeller) and tubing orientation should avoid trapping air that will interfere with pump priming.

The GPCTD has four sampling modes:

- **Continuous Sampling (1 – 4 sec intervals)** - The pump runs continuously, and the CTD or CTD/DO measurements are made at the chosen interval, producing a time series suitable for application of high-quality finish corrections (e.g., response filtering, alignment, thermal mass correction) for dynamic errors observed in the data. There is no power saving over 1 Hz (1/sec) sampling if sampling at 2, 3, or 4-sec intervals, but less memory is used.
- **Fast Interval Sampling (5 – 14 sec intervals)** - The pump runs continuously and CTD or CTD/DO measurements are made at the chosen interval, allowing users to conserve power (as compared to Continuous Sampling) by reducing the sample rate.
- **Slow Interval Sampling (15 sec and longer intervals; CTD only)** - The pump runs for 11.3 sec before plus 2.1 sec during each measurement (13.4 sec total). Then the CTD turns off the pump and goes into a low-power state until the next measurement. (Sea-Bird cannot offer data processing support for data acquired in this mode.) The optional SBE 43F DO sensor is not powered in this mode.
- **Spot Sampling** – Single measurements and transmission of P, CTP, or CTP and DO can be commanded for testing, diagnostic, vehicle-control, or situational awareness purposes, but data is not stored in memory.

The first three sampling modes are *autonomous* sampling; once sampling is started, the GPCTD automatically takes samples until commanded to stop. A file header (20 bytes) is created each time autonomous sampling starts, and contains beginning and ending sample numbers, sample interval, and cast starting date/time. A maximum of 1000 headers (casts) can be stored.

Data from autonomous sampling are stored in memory for later upload. If enabled, data are also output in real-time (increasing power consumption slightly). If real-time data output is disabled, a *Send Last Sample* command can be executed without interrupting autonomous sampling; if the GPCTD is taking a sample in Fast or Slow Interval Sampling mode when the command is sent, the reply is delayed slightly until the current sample is completed.

Future upgrades and enhancements to the firmware can be easily installed in the field through a computer serial port and the Data I/O, Power bulkhead connector.

Note:

The GPCTD's pump is not designed to be used to pump water through sensors other than the conductivity cell and optional integrated dissolved oxygen sensor. **Other sensors on your glider requiring pumped water need a separate pump.**

A GPCTD is supplied with:

- Plastic housing for depths to 350 meters (1150 feet) or Titanium housing for depths to 1500 meters (4920 feet)
- C, T, and P (four full scale ranges from 100 to 2000 decibars) sensors
- T-C Duct and pump for flow-controlled C, T, and DO sensor response
- Anti-foulant device fittings and expendable Anti-Foulant Devices
- RS-232 interface
- IE-55 bulkhead connectors

GPCTD options include:

- SBE 43F Dissolved Oxygen (DO) Sensor

Notes:

- Help files provide detailed information on the software.
- A separate software manual on CD-ROM contains detailed information on the setup and use of SBE Data Processing.
- Sea-Bird supplies the current version of our software when you purchase an instrument. As software revisions occur, we post the revised software on our website. See our website for the latest software version number, a description of the software changes, and instructions for downloading the software.

The GPCTD is supplied with a powerful Windows software package, Seasoft V2, which includes:

- **SeatermV2** - terminal program for easy communication and data retrieval. SeatermV2 is a *launcher*, and launches the appropriate terminal program for the selected instrument (**Seaterm232** for RS-232 instruments such as the GPCTD).
- **SBE Data Processing** – program for calculation and plotting of conductivity, temperature, pressure, auxiliary sensor data, and derived variables such as salinity and sound velocity.

Specifications

	Temperature	Conductivity	Pressure
Measurement Range	-5 to +42 °C	0 to 9 S/m (0 to 90 mS/cm)	0 to 100, 0 to 350, 0 to 1000, 0 to 2000 m (in meters of deployment depth capability)
Calibration Range	+1 to +32 °C	0 to 6 S/m (0 to 60 mS/cm)	Full scale
Accuracy (within calibration range)	±0.002 °C	± 0.0003 S/m (±0.003 mS/cm)	± 0.1% of full scale range
Accuracy (outside calibration range)	better than ± 0.004 °C ¹ ¹ Due to fit extrapolation errors.	better than ± 0.0010 S/m ¹ (better than ± 0.010 mS/cm ¹) ¹ Due to fit extrapolation errors.	--
Typical Stability	0.0002 °C per month	0.0003 S/m per month (0.003 mS/cm per month)	0.05% of full scale range per year
Resolution	0.001 °C	0.00001S/m (0.0001 mS/cm)	0.002% of full scale range
Power Requirements	<p>Supply Voltage: 8 to 20 VDC nominal (power calculations below assume 10.0 V)</p> <p>Quiescent current: 30 µA</p> <p>Continuous (1, 2, 3, or 4 sec) Sampling</p> <ul style="list-style-type: none"> • CTP only, real-time = no: 175 mW (2.10 Watt-hours/day @ 50% duty) • CTP only, real-time = yes: 190 mW (2.28 Watt-hours/day @ 50% duty) • CTP & DO, real-time = no: 265 mW (3.18 Watt-hours/day @ 50% duty) • CTP & DO, real-time = yes: 280 mW (3.36 Watt-hours/day @ 50% duty) <p>Fast Interval (5 -14 sec) Sampling</p> <ul style="list-style-type: none"> • CTP only, real-time = no: 0.225 Joules/measurement + (interval in sec * 0.068 W) • CTP only, real-time = yes: 0.172 Joules/measurement + (interval in sec * 0.108 W) • CTP & DO, real-time = no: 0.320 Joules/measurement + (interval in sec * 0.113 W) • CTP & DO, real-time = yes: 0.267 Joules/measurement + (interval in sec * 0.153 W) <p>Slow Interval (15 – 3600 sec) Sampling (CTP measurements only)</p> <ul style="list-style-type: none"> • CTP only, real-time = no: 1.188 Joules/measurement + (interval in sec * 0.0005 W) • CTP only, real-time = yes: 1.125 Joules/measurement + (interval in sec * 0.043 W) • CTP & DO ², real-time = no: 1.789 Joules/measurement + (interval in sec * 0.0005 W) • CTP & DO ², real-time = yes: 1.757 Joules/measurement + (interval in sec * 0.043 W) <p>² DO sensor is installed, so more pump power is required to pump water through the DO sensor, but DO is not measured in this mode.</p> <p>Spot Sampling</p> <ul style="list-style-type: none"> • P (no pumping, measurement takes 0.7 sec): = 0.09 Joules/measurement + 0.043 W * sec until next command ³ • CTP (with 11.3 sec pump time ³): 1.73 Joules/measurement + 0.043 W * sec until next command ⁴ • CTP & DO: Minimum, with 15 sec pump time ³: 3.03 Joules/measurement + 0.043 W * sec until next command ⁴. (Pumping time is 7 DO sensor time constants or 15 sec, whichever is longer, and is adaptively determined from the temperature and pressure immediately prior to sampling. At 4 °C and 750 decibars, 7 time constants is approximately 25 sec pump time ³, consuming 4.66 Joules/measurement + 0.043 W * sec until next command ⁴). <p>³ Pump time shown is time before sampling; pump runs additional 2.1 sec during sample. ⁴ For example, next command may be a Stop command.</p> <p>Battery Power Notes:</p> <ul style="list-style-type: none"> • Duracell D MN1300 - 20 Watt-hours or 72.0 Kjoules, nominal. • Duracell C MN1400 - 9 Watt-hours or 32.4 Kjoules, nominal. • Electrochem CSC93 DD (3B0036) – 368 Kjoules, nominal. 		
Memory	8 Mbytes: 699,000 CTP samples (194 hours at 1 Hz), or 559,000 CTP & DO samples (155 hours at 1 Hz)		
Data Formats	Real-time and uploaded data are output (decimal or Hexadecimal characters) in units of Siemens/meter (conductivity), degrees C (temperature), decibars (pressure), and Dissolved Oxygen frequency.		
Housing Material and Depth Rating	Plastic, 350 meters (1150 feet) Titanium, 1500 meters (4920 feet)		
Weight, CTD and Pump	Plastic Housing – In air: 1.0 kg (2.2 lbs), In water: 0.2 kg (0.4 lbs) Titanium Housing - In air: 1.2 kg (2.7 lbs), In water: 0.4 kg (0.9 lbs)		
Weight, Optional DO Sensor	Plastic Housing – In air: 0.3 kg (0.7 lbs), In water: 0.1 kg (0.2 lbs) Titanium Housing - In air: 0.4 kg (0.9 lbs), In water: 0.2 kg (0.4 lbs)		

Dimensions and Connectors

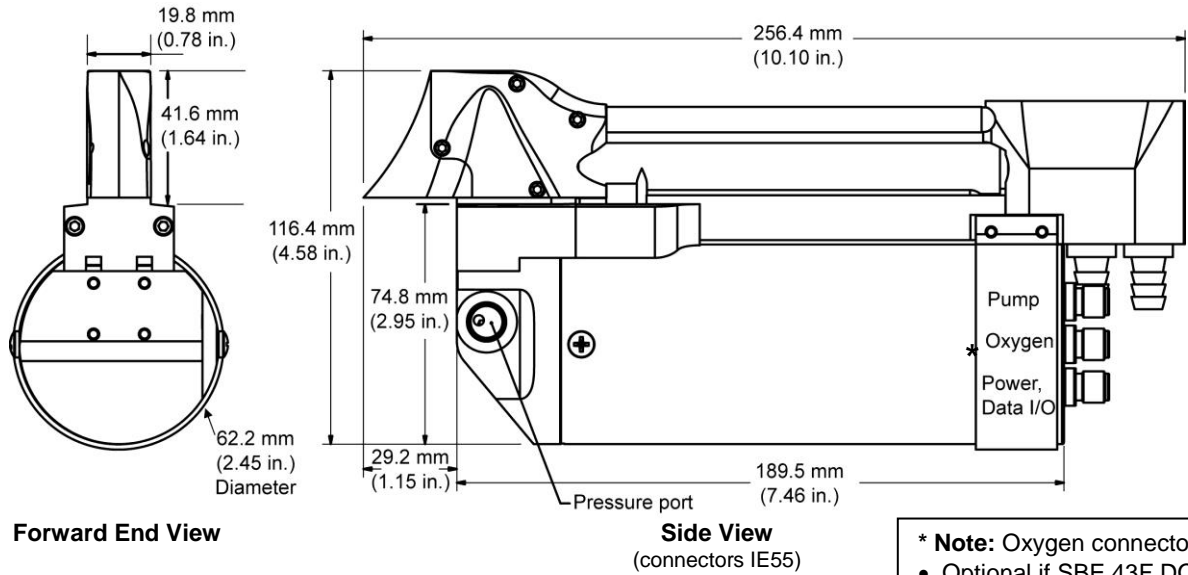

*** Note:** Oxygen connector:

- Optional if SBE 43F DO sensor not ordered
- Included if SBE 43F DO sensor ordered.

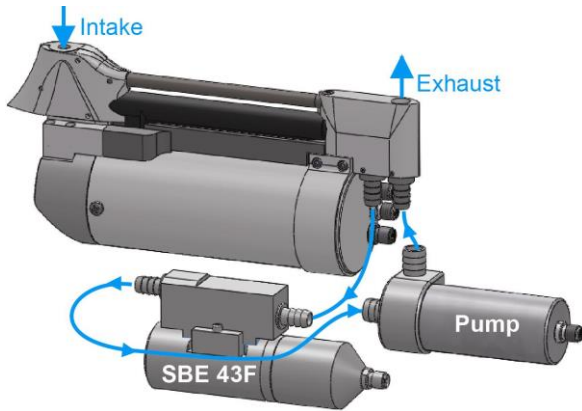

With Optional SBE 43F Oxygen Sensor
(plumbing approximate)

Pump		Oxygen		Power, Data I/O	
IE55(W)-1002-BCR		IE55(W)-1003-BCR		IE55-1204-BCR	
Pin	Description	Pin	Description	Pin	Description
1	Pump power common	1	Common	1	Common
2	Pump power +	2	DO frequency	2	RS-232 data receive
		3	DO power	3	RS-232 data transmit
				4	8 - 20 VDC external power

Notes:

1. Cables and plumbing not shown for clarity.
2. Route the plumbing (Tygon tubing from CTD to optional DO sensor, pump, and exhaust) so that it will not trap air.

Cables and Wiring

Data I/O and Power Cable Wiring -- DN 33511

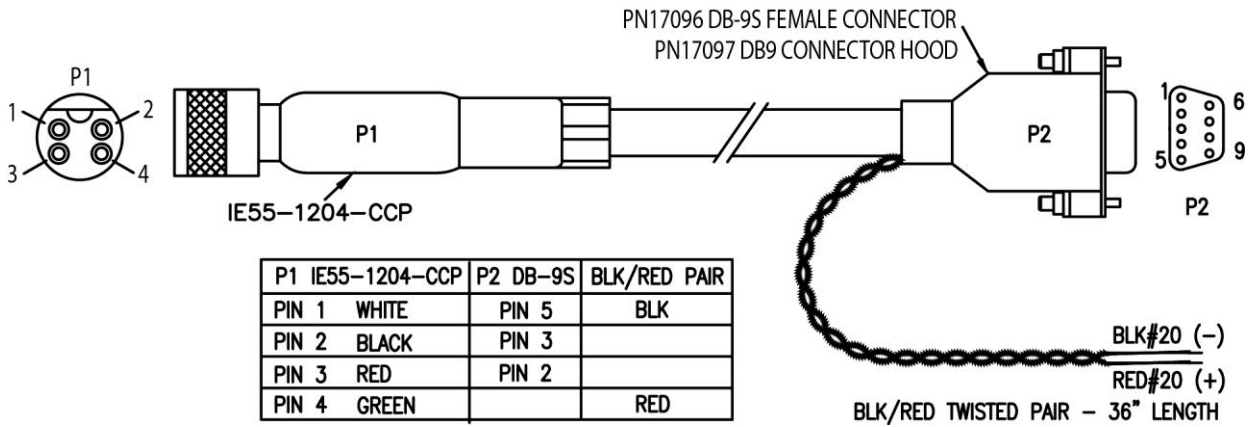

Pump Cable Wiring -- DN 33474

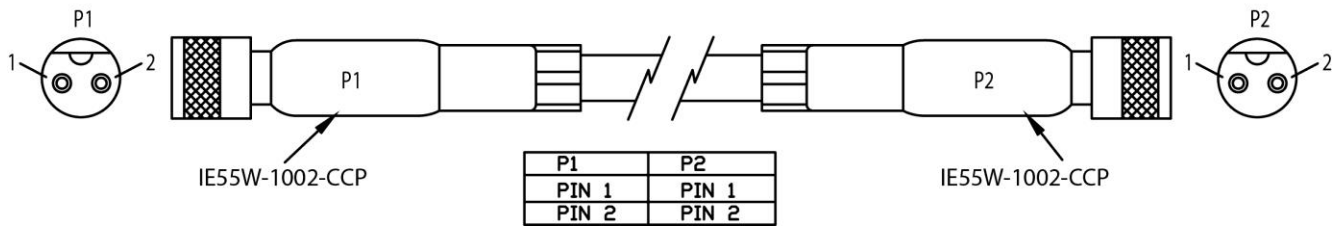

Optional Oxygen Cable Wiring -- DN 32561

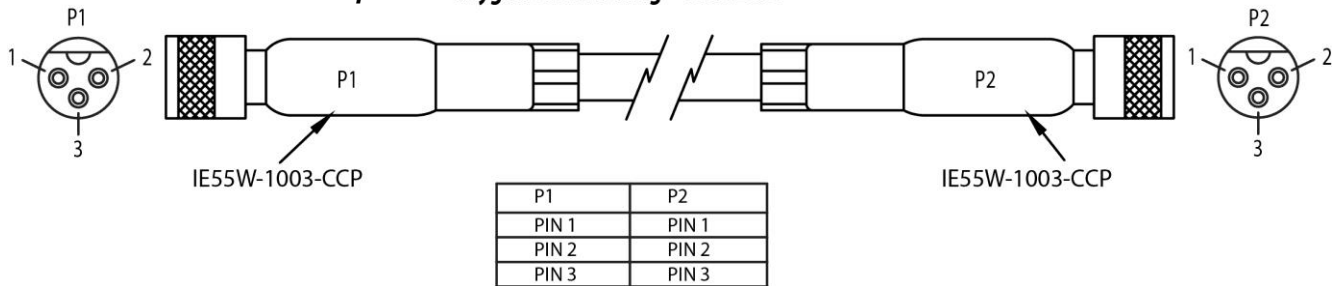

Glider Payload CTD Internal Wiring - Drawing 41734

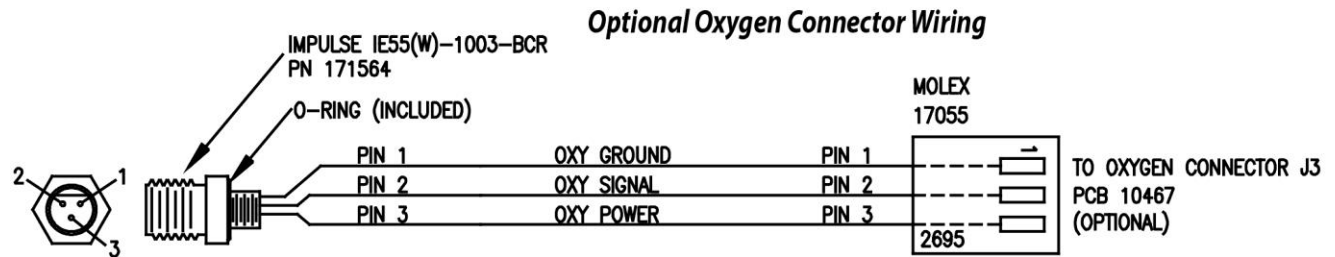
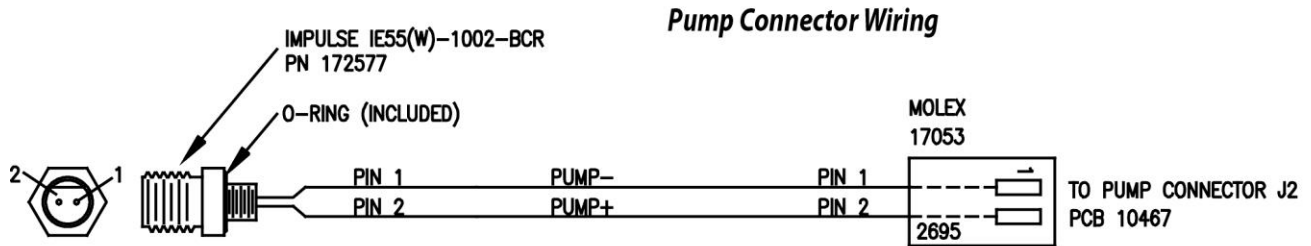
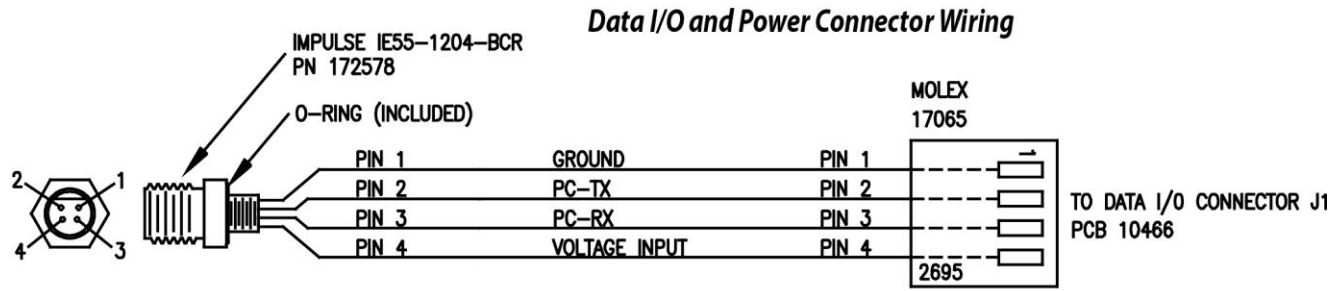

Data I/O

The GPCTD receives setup instructions and outputs data and diagnostic information via an RS-232 interface, and is factory-configured for 9600 baud, 8 data bits, 1 stop bit, and no parity. The communications baud rate can be changed using **BaudRate=** (see *Command Descriptions* in *Section 4: Deploying and Operating GPCTD*).

Data Storage

The GPCTD has an 8 Mbyte FLASH memory. If the memory is filled to capacity, data sampling and transmission of real-time data (if programmed) continue, but excess data is not saved in memory.

Sample Timing

Sample timing is dependent on the sampling mode and sample interval.

Note: Diagrams not to scale.

Continuous Sampling (Interval = 1 - 4 sec)

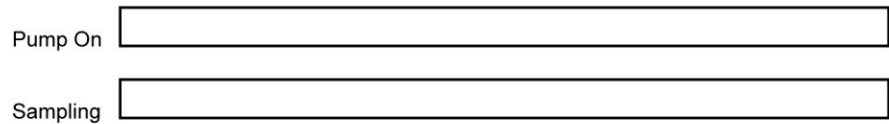

Fast interval Sampling (Interval = 5 - 14 sec)

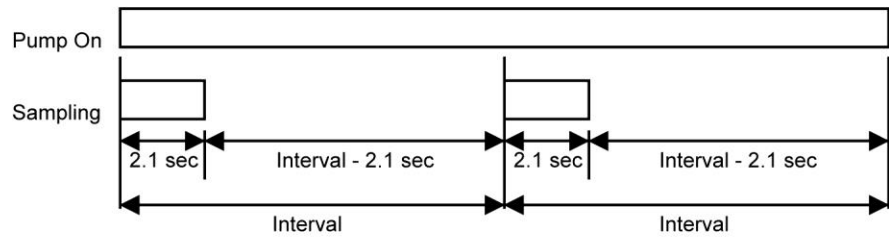

Slow interval Sampling (Interval = 15 - 3600 sec)

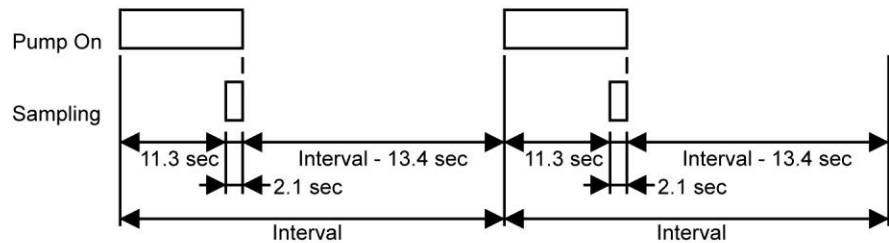

Spot Sampling (PTS command), no SBE 43F DO sensor

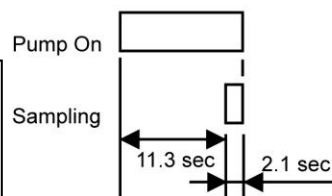

Spot Sampling (PTS command), with SBE 43F DO sensor



Notes:

- Spot sampling of all parameters using **TS**, **TSN:x**, or **TSR** requires 2.1 sec; the pump does not run.
- Spot sampling of Pressure only (**TP**) requires 0.7 sec; the pump does not run.
- See *Spot Sampling* in Section 4: *Deploying and Operating GPCTD* for details on calculating Adaptive Pump Time for various combinations of temperature and pressure.

Section 3:

Power and Communications Test

This section describes software installation and the pre-check procedure for preparing the GPCTD for deployment. The power and communications test will verify that the system works, prior to deployment.

Software Installation

Notes:

- Help files provide detailed information on the software. A separate software manual on the CD-ROM contains detailed information on SBE Data Processing.
- It is possible to use the GPCTD without the SeatermV2 terminal program by sending direct commands from a dumb terminal or terminal emulator, such as Windows HyperTerminal.
- Sea-Bird supplies the current version of our software when you purchase an instrument. As software revisions occur, we post the revised software on our website. See our website for the latest software version number, a description of the software changes, and instructions for downloading the software.

Seasoft V2 was designed to work with a PC running Windows XP service pack 2 or later, Windows Vista, or Windows 7 (32-bit or 64-bit).

If not already installed, install Sea-Bird software programs on your computer using the supplied software CD:

1. Insert the CD in your CD drive.
2. Install software: Double click on **SeasoftV2*.exe** (* is characters indicating the software version number). Follow the dialog box directions to install the software. The installation program allows you to install the desired components. Install all the components, or just install SeatermV2 (terminal program *launcher* for the GPCTD) and SBE Data Processing (post-processing software).

The default location for the software is c:\Program Files\Sea-Bird. Within that folder is a sub-directory for each program.

If you will be using a USB-to-Serial Port adapter to connect the instrument to a USB port on your computer: You must install the driver for the adapter. The driver should have been provided when you purchased the adapter, or you should be able to download it from the adapter manufacturer's website.

Test Setup

Note:

The I/O cable is **not** included as part of the typical shipment, and must be ordered separately.

1. Install a data I/O cable (4-pin IE55 to DB-9S with external power leads or battery snap), aligning the pins.
2. Connect the other end of the I/O cable to your computer and a power supply.

Test

Note:
See SeatermV2's Help files.

1. Double click on **SeatermV2.exe**. The main screen looks like this:

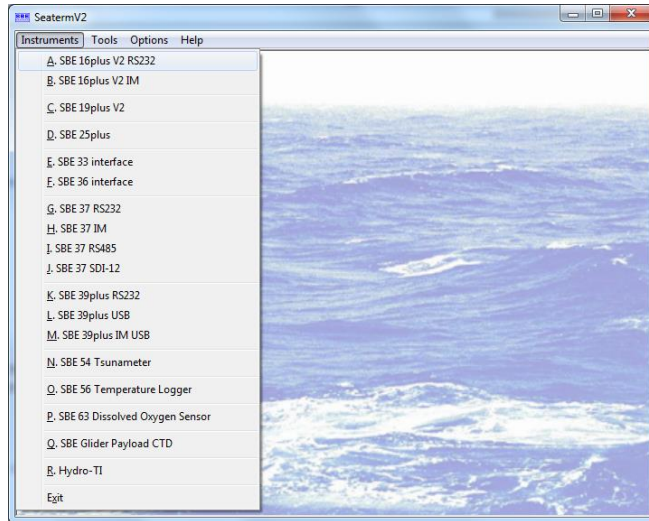

SeatermV2 is a *launcher*, and launches the appropriate terminal program for the selected instrument

Note:
See Seaterm232's Help files.

2. In the Instruments menu, select *SBE Glider Payload CTD*. **Seaterm232** opens; the main screen looks like this:

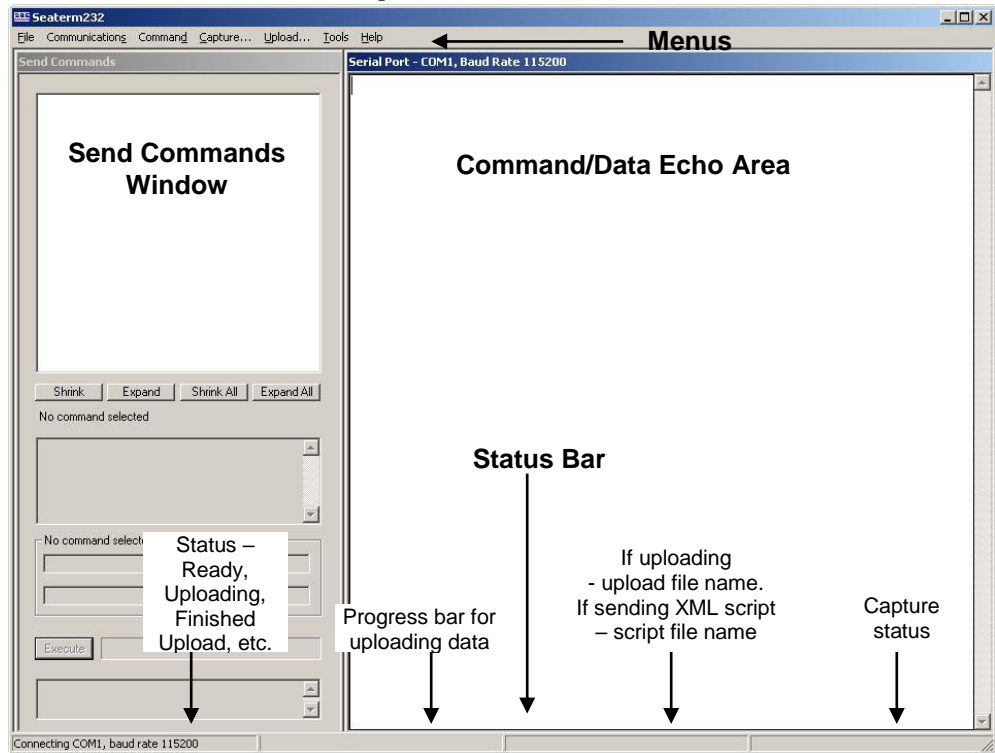

- Menu – For tasks and frequently executed instrument commands.
- Send Commands window – Contains commands applicable to your GPCTD. The list appears after you connect to the GPCTD.
- Command/Data Echo Area – Title bar of this window shows Seaterm232's current comm port and baud rate. Commands and the GPCTD responses are echoed here. Additionally, a command can be manually typed or pasted (ctrl + V) here. Note that the GPCTD must be *connected* and *awake* for it to respond to a command.
- Status bar – Provides connection, upload, script, and capture status information.

Following is a description of the menus:

Menu	Description	Equivalent Command*
File	<ul style="list-style-type: none"> • Load command file – opens selected .XML command file, and fills Send Commands window with commands • Unload command file – closes command file, and removes commands from Send Commands window • Exit - Exit program. 	-
Communications	<ul style="list-style-type: none"> • Connect – connect to comm port • Disconnect – disconnect from comm port • Configure – Establish communication parameters (comm port and baud rate). • Disconnect and reconnect – may be useful if GPCTD has stopped responding 	-
Command	<ul style="list-style-type: none"> • Abort – interrupt and stop GPCTD's response • Send 5 second break (not applicable to GPCTD) • Send stop command • Set local time– Set date and time to time sent by timekeeping software on your computer; accuracy ± 25 msec of time provided by computer. • Set UTC Time (Greenwich Mean Time) – Set date and time to time sent by timekeeping software on your computer; accuracy ± 25 msec of time provided by computer. 	<ul style="list-style-type: none"> • (press Esc key several times for Abort) • Stop • DateTime= • DateTime=
Capture	<p>Capture GPCTD responses on screen to file, to save real-time data or use for diagnostics. File has .cap extension. Click Capture again to turn off capture. Capture status displays in Status bar.</p>	—
Upload	<p>Upload data stored in memory, in format Sea-Bird's data processing software can use (after further processing, see the Tools menu below). Uploaded data has .xml extension. Before using Upload: stop logging by sending Stop.</p>	Several status commands and appropriate data upload command as applicable to user selection of range of data to upload (use Upload menu if you will be processing data with SBE Data Processing)
Tools	<ul style="list-style-type: none"> • Diagnostics log - Keep a diagnostics log. • Convert .XML data file – Using Upload menu automatically does this conversion. Tool is available if there was a problem with the automatic conversion, or if you did not apply oxygen hysteresis correction during upload, and decide that you want to apply it before processing data further. • Send script – Send XML script to GPCTD. May be useful if you have a number of GPCTDs to program with same setup. 	-

Note:

Set local time and *Set UTC time* are disabled if the baud rate in Seaterm232 is set to 115200, because the software cannot reliably set the time at that baud.

*See *Command Descriptions* in Section 4: *Deploying and Operating GPCTD*.

3. If this is the first time Seaterm232 is being used, the Serial Port Configuration dialog box displays:

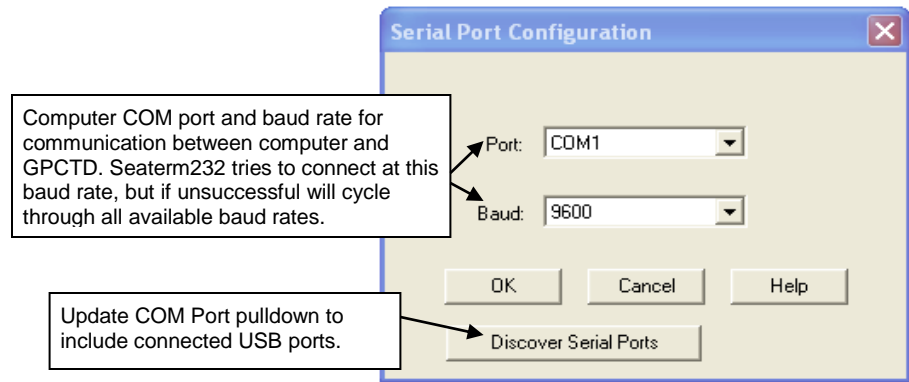

Make the desired selections, and click OK.

Note:

Seaterm232's baud rate must be the same as the GPCTD baud rate (set with **BaudRate=**). Baud is factory-set to 9600, but can be changed by the user (see *Command Descriptions* in *Section 4: Deploying and Operating GPCTD*). Other communication parameters – 8 data bits, 1 stop bit, and no parity – cannot be changed.

Note:

If **OutputExecutedTag=Y**, the GPCTD does **not** provide an **S>** prompt after the **<Executed/>** tag at the end of a command response.

4. Seaterm232 tries to automatically connect to the GPCTD. As it connects, it sends **GetHD** and displays the response, which provides factory-set data such as instrument type, serial number, and firmware version. Seaterm232 also fills the Send Commands window with the correct list of commands for your GPCTD.

If there is no communication:

- A. In the Communications menu, select *Configure*. The Serial Port Configuration dialog box appears. Select the Comm port and baud rate for communication, and click OK. Note that the factory-set baud rate is documented on the Configuration Sheet. .
- B. In the Communications menu, select *Connect* (if *Connect* is grayed out, select *Disconnect and reconnect*). Seaterm232 will attempt to connect at the baud specified in Step A, but if unsuccessful will then cycle through all other available baud rates.
- C. If there is still no communication, check cabling between the computer and GPCTD, and try to connect again.
- D. If there is still no communication, repeat Step A with a different comm port, and try to connect again.

After Seaterm232 displays the **GetHD** response, it provides an **S>** prompt to indicate it is ready for the next command.

Taking a look at the Send Commands window:

The screenshot shows the 'Send Commands' window with a tree view of 'SBE Glider Payload CTD Commands'. The 'General Setup' folder is expanded, showing options like 'Set Date and Time', 'Set Baud (serial communication) Rate', and 'Enter Quiescent (sleep) State'. Below the tree are buttons for 'Shrink', 'Expand', 'Shrink All', and 'Expand All'. A help box for 'DateTime=' shows the format 'mmddyyyyhhmmss'. Below that are two input fields for arguments. An 'Execute' button is present, and a box at the bottom right shows 'DateTime='.

Click on desired command description in list.

Help box describes selected command in more detail.

Enter any command arguments (such as date and time for setting date and time) in this box.

Click Execute when ready to send selected command.

This box shows selected command.

You can use the Send Commands window to send commands, or simply type the commands in the Command/Data Echo area if desired.

5. Display GPCTD status information by typing **DS** and pressing the Enter key. The display looks like this:

```
SBE Glider Payload CTD 1.2.1 SERIAL NO. 12345 25 Sep 2013 09:38:22
vMain = 9.37, vLith = 3.04
autorun = no
samplenum = 57, free = 559183, profiles = 3
not logging
sample every 1 seconds
sample mode is continuous
data format = raw Decimal
do not force on RS232 transmitter
transmit real time data
acquire SBE 43 oxygen
minimum conductivity frequency = 3011.0
custom pump mode disabled
```

Note:

The GPCTD automatically enters quiescent (sleep) state after 2 minutes without receiving a command. This timeout algorithm is designed to conserve power if the user does not send **QS** to put the GPCTD to sleep. If the system does not appear to respond, click Connect in the Communications menu to reestablish communications.

6. Command the GPCTD to take a sample by typing **PTS** and pressing the Enter key. The display looks like this if **OutputFormat=1** (engineering units, decimal characters):

```
1174.49, 9.4867, 3.99516, 2610.58
```

where 1174.49 = pressure (db)
 9.4867 = temperature (degrees C)
 3.99516 = conductivity (S/m)
 2610.58 = dissolved oxygen frequency (Hz)

These numbers should be reasonable for the present environment of your instrument (for example, in air, in fresh water, or in seawater).

7. Command the GPCTD to go to sleep (quiescent state) by typing **QS** and pressing the Enter key.

The GPCTD is ready for programming and deployment.

CAUTION:

Sending **PTS** causes the pump to turn on. **Do not run the pump dry.** The pump is water lubricated; running it without water (except for very short periods) will damage it. If testing your system in dry conditions, fill the inside of the pump head with water via the pump exhaust tubing. This will provide enough lubrication to prevent pump damage during testing.

Section 4:

Deploying and Operating GPCTD

This section includes discussions of:

- Sampling modes, including pump operation and example commands
- Command descriptions
- Data formats
- Optimizing data quality
- Deployment
- Recovery
- Uploading and Processing Data

Sampling Modes

The GPCTD has four sampling modes for obtaining data: Continuous, Fast Interval, Slow Interval, and Spot Sampling. The first three are what we call *autonomous* sampling; once sampling is started, the GPCTD automatically takes samples until commanded to stop.

Descriptions and examples of the sampling modes follow. Note that the GPCTD's response to each command is not shown in the examples. Review the operation of the sampling modes and the commands described in *Command Descriptions* before setting up your system.

Autonomous Sampling

Autonomous sampling can be started and stopped by command (if **AutoRun=N**), or by simply applying and removing power (if **AutoRun=Y**).

A file header (20 bytes) is created each time Continuous or Interval Sampling is initiated, and contains beginning and ending sample numbers, sample mode, time between samples, and cast starting date/time. A maximum of 1000 headers (casts) can be stored.

Note:

If the FLASH memory is filled to capacity, sampling continues, but excess data is not saved in memory (i.e., the GPCTD does not overwrite the data in memory).

Data from Continuous or Interval Sampling are stored in memory for later upload. If **TxRealTime=Y**, data is also output in real-time, increasing power consumption slightly. A *Send Last Sample* command can be executed without interrupting Continuous or Interval Sampling. If the CTD is taking a sample in Interval Sampling mode when the command is sent, the reply is delayed slightly until the current sample is completed.

Continuous Sampling

The pump and the acquisition circuitry run continuously, and the CTD (or CTD/DO) samples every 1, 2, 3, or 4 sec, producing a time series suitable for application of high-quality finish corrections for dynamic errors observed in the data (e.g., response filtering, alignment, thermal mass correction). There is no power saving over 1 Hz (1/sec) sampling if sampling at 2, 3, or 4-sec intervals, but less memory is used.

Fast Interval Sampling

When the interval between samples is 5 (minimum) to 14 sec, the pump runs continuously and CTD (or CTD/DO) measurements are made at the chosen interval, allowing users to conserve power (as compared to Continuous Sampling) by reducing the sample rate.

Slow Interval Sampling (CTD only)

When the interval is 15 sec or longer, the pump runs for 11.3 sec before each CTD measurement, plus 2.1 sec during the measurement (13.4 sec total). Then the CTD turns off the pump and goes into a low-power state until the next measurement. (Sea-Bird cannot offer data processing support for data sets acquired in this mode.) The optional SBE 43F DO sensor is not powered in this mode.

Example 1: Continuous or Interval Sampling Setup – AutoRun=N (user input in bold)

In the lab, using Seaterm232, set up GPCTD. Set date and time to May 9, 2014 9:00 am. Initialize logging to overwrite previous data in memory. Set up to sample at 1 sample/sec (1 Hz continuous sampling), output real-time data in decimal engineering units, and to require a **Start** command before it starts sampling. Verify setup with status command. Remove power.

(Apply power, then send any character to wake up.)

DATE**TIME=05092014090000**

RESETLOGGING

INTERVAL=1

TXREALTIME=Y

OUTPUTFORMAT=1

AUTORUN=N

GETCD (to verify setup)

QS

(Remove power.)

When ready to deploy:

(Fill conductivity cell and plumbing with fresh water. Put glider in water, send down below the surface so the GPCTD does not ingest dirty surface water. Apply power to GPCTD, and then send any character to wake up GPCTD.)

START (to start autonomous sampling)

When ready to recover, but before glider is at surface (to avoid ingesting dirty surface water by turning off pump before it reaches surface), send **Stop** (you may need to send it several times before GPCTD responds), and then send **GetSD** to verify sampling stopped (response should show <AutonomousSampling>no</AutonomousSampling>). Send **QS**. Remove power (you will lose any data in the 256 byte RAM buffer, up to 22 samples of CTP or 19 samples of CTP & DO. **To avoid losing small amount of data in buffer, do not remove power until after you have uploaded data**).

On deck or on land, upload GPCTD data from memory if desired:

Click Connect in Seaterm232's Communications menu to connect and wake up.

Click Upload– Seaterm232 leads you through screens to define data to be uploaded and where to store it.

Send **QS** and remove power.

Example 2: Continuous or Interval Sampling Setup – AutoRun=Y (user input in bold)

In the lab, using Seaterm232, set up GPCTD. Set date and time to May 9, 2014 9:00 am. Initialize logging to overwrite previous data in memory. Set up to sample at 1 sample/sec (1 Hz continuous sampling), output real-time data in decimal engineering units, and to start sampling automatically when power applied. Verify setup with status command. Remove power.

(Apply power, then send any character to wake up.)

DATE**TIME=05092014090000**

RESETLOGGING

INTERVAL=1

TXREALTIME=Y

OUTPUTFORMAT=1

AUTORUN=Y

GETCD (to verify setup)

QS

(Remove power.)

When ready to deploy:

(Fill conductivity cell and plumbing with fresh water. Put glider in water, send down below the surface so the GPCTD does not ingest dirty surface water. Apply power to GPCTD; sampling starts automatically.)

When ready to recover, but before glider is at surface (to avoid ingesting dirty surface water by turning off pump before it reaches surface):

- Remove power (you will lose any data in the 256 byte RAM buffer, up to 22 samples of CTP or 19 samples of CTP & DO), **or**.
- **To avoid losing small amount of data in buffer, do not remove power until after you have uploaded data**. Send **Stop** (you may need to send it several times before GPCTD responds), and then send **GetSD** to verify sampling stopped (response should show <AutonomousSampling>no</AutonomousSampling>).

On deck or on land, upload GPCTD data from memory if desired:

1. Click Connect in Seaterm232's Communications menu to connect and wake up.
2. Click Upload– Seaterm232 leads you through screens to define data to be uploaded and where to store it.
3. Send **QS** and remove power.

Spot Sampling

Single measurements and transmission of P, CTP, or CTP and DO can be commanded for testing, diagnostic, vehicle-control, or situational awareness purposes, but data is not stored in memory.

Pumped Spot Sampling

PTS command – GPCTD runs the pump before sampling, ensuring a conductivity and optional dissolved oxygen measurement based on a fresh water sample. Pump time varies:

- No SBE 43F DO sensor installed (**OxygenInstalled=N**): The GPCTD runs the pump for 11.3 sec, and continues to run the pump for an additional 2.1 sec while the measurement is made.
- SBE 43F DO sensor installed (**OxygenInstalled=Y**): Oxygen sensor response time, and the corresponding length of time the pump needs to run before taking a sample, is dependent on temperature and pressure. Oxygen sensor response time increases with increasing pressure and decreasing temperature. Therefore, the GPCTD takes a *preliminary* measurement of temperature and pressure (but does not store the preliminary values in memory), uses those values to calculate the required pump time, runs the pump, and then takes a fresh measurement of all parameters. This *Adaptive Pump Control* is described in more detail below.

Example: Spot Sampling (user input in bold)

Example 1: Apply power and send any character to wake up GPCTD. Command GPCTD to take a sample and output data in decimal engineering units, using **PTS** command (automatically runs pump for sample). Remove power. Repeat as desired.

(Apply power, then send any character to wake up GPCTD.)

PTS

(Remove power.)

Adaptive Pump Control Algorithm

(only applicable if SBE 43F DO sensor installed and enabled)

$$A = 2.549$$

$$B = -1.106 \times 10^{-1}$$

$$C = 1.571 \times 10^{-3}$$

$$pcor = 1.45 \times 10^{-4}$$

OxTau20 = oxygen sensor calibration coefficient (see calibration sheet)

P = pressure in decibars

T = temperature in °C

$$ft = A + (B * T) + (C * T^2)$$

$$fp = e^{(pcor * P)}$$

$$\text{tau} = \text{oxtau20} * ft * fp \quad (\text{minimum tau 2.0, maximum tau 10.0})$$

$$\text{pump time} = 7.0 * \text{tau} \quad (\text{minimum pump time 15.0})$$

Note:

The GPCTD uses an SBE 43F with a 0.5-mil membrane. For the 0.5-mil membrane, OxTau20 has a typical (average) value of 1.5. Actual values for OxTau20 vary; check your SBE 43F calibration sheet.

Looking at pump times in the range of oceanographic values, using a typical OxTau20 value of 1.5:

T (°C)	P (db)	Ft	Fp	Tau (OxTau20=1.5)	Pump Time before sampling (sec) (OxTau20=1.5)
-3	1500	2.89	1.24	5.4	37.6
-3	0	2.89	1.0	4.3	30.3
0	0	2.549	1.0	3.8	26.8
0	1500	2.549	1.24	4.7	33.2
4	0	2.132	1.0	3.2	22.4
4	1500	2.132	1.24	4.0	28.0
20	0	0.9654	1.0	1.4 → 2.0	14 → 15
20	1500	0.9654	1.24	1.8 → 2.0	14 → 15

Unpumped Spot Sampling for Diagnostics

Unpumped sampling is recommended for diagnostic purposes only; you must run the pump to get good quality data.

- **TS** or **TSR** command – GPCTD pump does not turn on automatically before sampling. If desired, send **PumpFast** or **PumpSlow** to turn the pump on before sending **TS** or **TSR**; send **PumpOff** to turn the pump off after taking the sample.
- **TSN:x** command – GPCTD pump does not turn on automatically before sampling. If desired, send **PumpFast** or **PumpSlow** to turn the pump on before sending **TSN:x**; send **PumpOff** to turn the pump off after taking the samples.

Example: Unpumped Spot Sampling (user input in bold)

Apply power and send any character to wake up GPCTD. Command GPCTD to turn pump on with 4 V power, take a sample and output raw data, and turn pump off. Remove power. Repeat as desired.

(Apply power, then send any character to wake up GPCTD.)

PUMPSLOW

TSR

PUMPOFF

(Remove power.)

Command Descriptions

This section describes commands and provides sample outputs.

See *Appendix II: Command Summary* for a summarized command list.

When entering commands:

- Establish communications by selecting Connect in Seaterm232's Communications menu or pressing the Enter key.
- Input commands to the GPCTD in upper or lower case letters and register commands by pressing the Enter key.
- The GPCTD sends an error message if an invalid command is entered.
- (if **OutputExecutedTag=N**) If the GPCTD does not return an **S>** prompt after executing a command, press the Enter key to get the **S>** prompt.
- If a new command is not received within 2 minutes after the completion of a command, the GPCTD returns to the quiescent (sleep) state.
- Commands to enable a parameter or output (such as enabling real-time data when autonomous sampling) can be entered with the *argument* as Y or 1 for yes, and N or 0 for no (for example, **TxRealTime=Y** and **TxRealTime=1** are equivalent, both enable real-time data output).
- If the GPCTD is transmitting data and you want to stop it, press the Esc key or type ^C. Then press the Enter key. Alternatively, select *Abort* in Seaterm232's Command menu.
- The GPCTD responds only to **GetCD**, **GetSD**, **GetCC**, **GetEC**, **GetHD**, **DS**, **DC**, **SL**, **SLP**, **QS**, and **Stop** while sampling.

Entries made with the commands are permanently stored in the GPCTD and remain in effect until you change them. Removing power does not affect the user-programmed setup.

Status Commands

Notes:

- **GetCD** output does not include calibration coefficients. To display calibration coefficients, use the **GetCC** command.
- The **DS** response contains similar information as the combined responses from **GetSD** and **GetCD**, but in a different format.

GetCD

Get and display configuration data in XML format, which includes all parameters related to setup of GPCTD, including communication settings and sampling settings. Most of these parameters can be user-input/modified. List below includes, where applicable, command used to modify parameter:

- Device type, Serial number
- Data output format [**OutputFormat=**]
- Enable Tx when Rx is valid [**RS232ForceOn=**]?
- Transmit data real-time for autonomous sampling [**TxRealTime=**]?
- Sample interval for autonomous sampling [**SampleInterval=**]
- Sampling mode (Continuous, Fast Interval sampling, or Slow Interval sampling, based on **Interval=**)
- Start sampling automatically when power applied [**AutoRun=**]?
- Enable measurements with SBE 43F dissolved oxygen sensor [**OxygenInstalled=**]?
- Minimum conductivity frequency for pump turn-on [**MinCondFreq=**]
- Enable custom pump mode to run pump at fast speed, even if no oxygen sensor installed [**CustomPumpMode=**]?

Example: (user input in bold, command used to modify parameter in parentheses)

getcd

```
<ConfigurationData DeviceType = 'SBE Glider Payload CTD' SerialNumber = '70112345'>
  <SampleDataFormat>raw Decimal</SampleDataFormat>           [OutputFormat=]
  <RS232ForceOn>no</RS232ForceOn>                             [RS232ForceOn=]
  <TxRealTime>yes</TxRealTime>                                 [TxRealTime=]
  <SampleInterval>1</SampleInterval>                           [Interval=]
  <SampleMode>Continuous</SampleMode>                         [based on Interval=]
  <AutoRun>no</AutoRun>                                        [AutoRun=]
  <SBE43>yes</SBE43>                                          [OxygenInstalled=]
  <MinCondFreq>3011.0</MinCondFreq>                           [MinCondFreq=]
  <CustomPumpMode>no</CustomPumpMode>                         [CustomPumpMode=]
</ConfigurationData>
```

Status Commands (*continued*)

Note:

The **DS** response contains similar information as the combined responses from **GetSD** and **GetCD**, but in a different format.

GetSD

Get and display status data in XML format, which contains data that changes while deployed. List below includes, where applicable, command used to modify parameter:

- Device type, Serial number
- Date and time [**DateTime=**] in ISO8601-2000 extended format (yyyy – mm-ddThh:mm:ss)
- Number of recorded events in event counter [reset with **ResetEC**]
- Voltages and currents -
 - Main battery voltage
 - Back-up lithium battery voltage
- Memory - [reset with **ResetLogging**]
 - Number of bytes in memory
 - Number of samples in memory
 - Number of additional samples that can be placed in memory
 - Length (number of bytes) of each sample
 - Number of profiles in memory
- Logging status (not logging, logging, or unknown status)

Example: (user input in bold, command used to modify parameter in parentheses)

getsd

```
<StatusData DeviceType = 'SBE Glider Payload CTD' SerialNumber = '70112345'>
  <DateTime>2014-07-17T09:38:36</DateTime>                                [DateTime=]
  <EventSummary numEvents = '65' />                                     [can clear with ResetEC]
  <Power>
    <vMain> 9.37</vMain>
    <vLith> 3.04</vLith>
  </Power>
  <MemorySummary>
    <Bytes>855</Bytes>                                                  [can clear with ResetLogging]
    <Samples>57</Samples>                                             [can clear with ResetLogging]
    <SamplesFree>559183</SamplesFree>                                  [can clear with ResetLogging]
    <SampleLength>15</SampleLength>
    <Profiles>3</Profiles>                                           [can clear with ResetLogging]
  </MemorySummary>
  <AutonomousSampling>no, never started</AutonomousSampling>
</StatusData>
```

Status Commands (*continued*)**Notes:**

- **DC** and **GetCC** responses contain similar information, but in different formats.
- Dates shown are when calibrations were performed.

GetCC

Get and display calibration coefficients in XML format, which are initially factory-set and should agree with Calibration Certificates shipped with GPCTD.

Note that GPCTD always outputs Dissolved Oxygen as raw oxygen frequency. DO calibration coefficients are used only to create configuration (.xmlcon) file when you upload data from memory. The .xmlcon file is used to process data in SBE Data Processing (see *Uploading and Processing Data*).

Example: (user input in bold, command used to modify coefficient in parentheses)

getcc

```
<CalibrationCoefficients DeviceType = 'SBE Glider Payload CTD' SerialNumber = '70112345'>
  <Calibration format = 'TEMP1' id = 'Main Temperature'>
    <SerialNum>01606001</SerialNum>
    <CalDate>19-Jul-13</CalDate> [TCalDate=]
    <TA0>1.155787e-03</TA0> [TA0=]
    <TA1>2.725208e-04</TA1> [TA1=]
    <TA2>-7.526811e-07</TA2> [TA2=]
    <TA3>1.716270e-07</TA3> [TA3=]
    <TOFFSET>0.000000e+00</TOFFSET> [TOffset=]
  </Calibration>
  <Calibration format = 'WBCOND0' id = 'Main Conductivity'>
    <SerialNum>01606001</SerialNum>
    <CalDate>19-Jul-13</CalDate> [CCalDate=]
    <G>-1.006192e+00</G> [CG=]
    <H>1.310565e-01</H> [CH=]
    <I>-2.437852e-04</I> [CI=]
    <J>3.490353e-05</J> [CJ=]
    <PCOR>-9.570000e-08</PCOR> [CPCor=]
    <TCOR>3.250000e-06</TCOR> [CTCor=]
    <WBOTC>-1.351281e-07</WBOTC> [WBOTC=]
  </Calibration>
  <Calibration format = 'STRAIN0' id = 'Main Pressure'>
    <SerialNum>01600003</SerialNum>
    <CalDate>27-Jul-13</CalDate> [PCalDate=]
    <PA0>-5.137085e-02</PA0> [PA0=]
    <PA1>1.550601e-03</PA1> [PA1=]
    <PA2>7.210415e-12</PA2> [PA2=]
    <PTCA0>5.154159e+05</PTCA0> [PTCA0=]
    <PTCA1>2.560262e-01</PTCA1> [PTCA1=]
    <PTCA2>-8.533080e-02</PTCA2> [PTCA2=]
    <PTCB0>2.426612e+01</PTCB0> [PTCB0=]
    <PTCB1>-7.750000e-04</PTCB1> [PTCB1=]
    <PTCB2>0.000000e+00</PTCB2> [PTCB2=]
    <PTEMPA0>-7.667877e+01</PTEMPA0> [PTempA0=]
    <PTEMPA1>4.880376e+01</PTEMPA1> [PTempA1=]
    <PTEMPA2>-4.555938e-01</PTEMPA2> [PTempA2=]
    <POFFSET>0.000000e+00</POFFSET> [POffset= (decibars)]
    <PRANGE>1.000000e+03</PRANGE> [PRange= (psia)]
  </Calibration>
  <Calibration format = 'SBE43F0' id = 'Oxygen'>
    <SerialNum>sbe43F</SerialNum>
    <CalDate>27-Aug-13</CalDate> [OCalDate=]
    <FOffset>3.000000e+03</FOffset> [OxFOffset=]
    <SOC>1.000000e+00</SOC> [OxSoc=]
    <A>2.000000e+00</A> [OxA=]
    <B>3.000000e+00</B> [OxB=]
    <C>4.000000e+00</C> [OxC=]
    <E>5.000000e+00</E> [OxE=]
    <Tau20>1.000000e+00</Tau20> [OxTau20=]
    <D1>6.000000e+00</D1> [OxD1=]
    <D2>7.000000e+00</D2> [OxD2=]
    <H1>8.000000e+00</H1> [OxH1=]
    <H2>9.000000e+00</H2> [OxH2=]
    <H3>1.000000e+01</H3> [OxH3=]
  </Calibration></CalibrationCoefficients>
```

Status Commands (*continued*)

GetEC

Get and display event counter data in XML format, which can help to identify root cause of a malfunction. Event counter records number of occurrences of common timeouts, power-on resets, etc. Can be cleared with **ResetEC**.

Possible events that may be logged include:

- WDT reset – unexpected reset
- PON reset – power cycled on (each time power is applied)
- ErrorADC12TimeOut – response delayed from A/D converted that measures power and back-up lithium battery power
- ErrorUART0TimeOut – timeout for transmitter to finish transmitting previous character via RS-232
- ErrorAD7714 timeout – response delayed from temperature and pressure A/D converter; typically if woke up to send a command while logging
- ErrorFLASH timeout – problem with writing data to FLASH memory

Example (user input in bold, command used to modify parameter in parentheses)

getec

```
<EventCounters DeviceType = 'SBE Glider Payload CTD' SerialNumber = '70112345'>
  <EventSummary numEvents = '65' />
  <Event type = 'WDT reset' count = '3' />
  <Event type = 'PON reset' count = '62' />
</EventCounters>
```

ResetEC

Delete all events in event counter (number of events displays in **GetSD** response, and event details display in **GetEC** response).

Status Commands (*continued*)**GetHD**

Get and display hardware data in XML format, which is fixed data describing GPCTD:

- Device type, Serial number
- Manufacturer
- Firmware version
- Firmware date
- PCB assembly numbers and serial numbers
- Manufacture date
- Internal sensor types and serial numbers
- External sensor type (dissolved oxygen) and serial number

Example: (user input in bold, command used to modify parameter in parentheses)

gethd

```

<HardwareData DeviceType = 'SBE Glider Payload CTD' SerialNumber = '70112345'>
  <Manufacturer>Sea-Bird Electronics, Inc.</Manufacturer>
  <FirmwareVersion>1.2.1</FirmwareVersion>
  <FirmwareDate>Sep 20 2013 13:17:19</FirmwareDate>
  <CommandSetVersion>1.1</CommandSetVersion>
  <PCBAssembly>41720A</PCBAssembly>
  <PCBSerialNum>50763</PCBSerialNum>
  <PCBAssembly>41660B</PCBAssembly>
  <PCBSerialNum>50874</PCBSerialNum>
  <PCBAssembly>41661B</PCBAssembly>
  <PCBSerialNum>49205</PCBSerialNum>
  <PCBAssembly>41662A</PCBAssembly>
  <PCBSerialNum>48720</PCBSerialNum>
  <MfgDate>01 Aug 2013</MfgDate>
  <FirmwareLoader>SBE 37 FirmwareLoader V 1.0</FirmwareLoader>
  <InternalSensors>
    <Sensor id = 'Temperature'>
      <type>temperature-1</type>
      <SerialNumber>12345</SerialNumber>
    </Sensor>
    <Sensor id = 'Conductivity'>
      <type>conductivity-1</type>
      <SerialNumber>12345</SerialNumber>
    </Sensor>
    <Sensor id = 'Pressure'>
      <type>strain-0</type>
      <SerialNumber>psn</SerialNumber>
    </Sensor>
  </InternalSensors>
  <ExternalSensors>
    <Sensor id = 'Oxygen'>
      <type>SBE43F</type>
      <SerialNumber>12345</SerialNumber>
    </Sensor>
  </ExternalSensors>
</HardwareData>

```

[SetPCBAssembly1=]
[SetPCBSerialNum1=]
[SetPCBAssembly2=]
[SetPCBSerialNum2=]
[SetPCBAssembly3=]
[SetPCBSerialNum3=]
[SetPCBAssembly4=]
[SetPCBSerialNum4=]
[SetMfgDate=]

Status Commands (*continued*)**DS**

Display operating status and setup parameters.

List below includes, where applicable, command used to modify parameter.

- Firmware version, serial number, date and time
- External power voltage, internal lithium battery voltage
- Start sampling automatically when power applied [**AutoRun=**]?
- Number of samples in memory, space available for additional samples, number of profiles in memory [reset with **ResetLogging**]
- Logging status (not logging, logging, or unknown status)
- Sample interval for autonomous sampling [**Interval=**]
- Sampling mode (Continuous, Fast Interval sampling, or Slow Interval sampling, based on **Interval=**)
- Data output format [**OutputFormat=**]
- Enable Tx when Rx is valid [**RS232ForceOn=**]?
- Transmit real-time data for autonomous sampling [**TxRealTime=**]?
- Enable measurements with SBE 43F dissolved oxygen sensor [**OxygenInstalled=**]?
- Minimum conductivity frequency for pump turn-on [**MinCondFreq=**]
- Enable custom pump mode to run pump at fast speed, even if no oxygen sensor installed [**CustomPumpMode=**]?

Example: (user input in bold; command used to modify parameter in parentheses)

DS

```

SBE Glider Payload CTD 1.2.1 SERIAL NO. 12345 25 Sep 2013 09:38:22           [DateTime=]
vMain = 9.37, vLith = 3.04
autorun = no                                                                [AutoRun=]
samplenumber = 57, free = 559183, profiles = 3                             [reset with ResetLogging]
not logging, never started
sample every 1 seconds                                                     [Interval=]
sample mode is continuous                                                  [based on Interval=]
data format = raw Decimal                                                 [OutputFormat=]
do not force on RS232 transmitter                                         [RS232ForceOn=]
transmit real time data                                                   [TxRealTime=]
acquire SBE 43 oxygen                                                      [OxygenInstalled=]
minimum conductivity frequency = 3011.0                                   [MinCondFreq=]
custom pump mode disabled                                                 [CustomPumpMode=]

```

Status Commands (*continued*)**DC**

Display calibration coefficients.

Note that GPCTD always outputs Dissolved Oxygen as raw oxygen frequency. DO calibration coefficients are used only to create configuration (.xmlcon) file when you upload data from memory. The .xmlcon file is used to process data in SBE Data Processing (see *Uploading and Processing Data*).

Notes:

- Dates shown are when calibrations were performed. Calibration coefficients are initially factory-set and should agree with Calibration Certificate shipped with GPCTD.
- See individual Coefficient Commands below for definitions of the data in the example.

Example: (user input in bold, command used to modify parameter in parentheses).

```

dc
SBE Glider Payload CTD V 1.2.1 12345
temperature: 22-Jul-13 [TCalDate=]
    TA0 = 4.053247e-05 [TA0=]
    TA1 = 2.687087e-04 [TA1=]
    TA2 = -2.077398e-06 [TA2=]
    TA3 = 1.396745e-07 [TA3=]
conductivity: 22-Jul-13 [CCalDate=]
    G = -1.023995e+00 [CG=]
    H = 1.688432e-01 [CH=]
    I = -3.535489e-04 [CI=]
    J = 5.479864e-05 [CJ=]
    CPCOR = -9.570000e-08 [CPCor=]
    CTCOR = 3.250000e-06 [CTCor=]
    WBOTC = -1.351281e-07 [WBOTC=]
pressure S/N 1234, range = 0 psia 20-Jul-13 [PCalDate=, PRange= (psia)]
    PA0 = 6.580878e-02 [PA0=]
    PA1 = 4.666308e-03 [PA1=]
    PA2 = -2.362889e-11 [PA2=]
    PTCA0 = 5.243161e+05 [PTCA0=]
    PTCA1 = 2.471850e+00 [PTCA1=]
    PTCA2 = -9.465127e-02 [PTCA2=]
    PTCB0 = 2.548063e+01 [PTCB0=]
    PTCB1 = -2.750000e-04 [PTCB1=]
    PTCB2 = 0.000000e+00 [PTCB2=]
    PTEMPA0 = -7.044176e+01 [PTempA0=]
    PTEMPA1 = 4.919073e-02 [PTempA1=]
    PTEMPA2 = -2.383647e-07 [PTempA2=]
    POFFSET = 0.000000e+00 [POffset= (decibars)]
SBE 43 S/N 5678 26-Jul-13 [OCalDate=]
FOFFSET = 3.000000e+03 [OxOffset=]
SOC = 1.000000e+00 [OxSoc=]
A = 2.000000e+00 [OxA=]
B = 3.000000e+00 [OxB=]
C = 4.000000e+00 [OxC=]
E = 5.000000e+00 [OxE=]
TAU20 = 1.000000e+00 [OxTau20=]
D1 = 6.000000e+00 [OxD1=]
D2 = 7.000000e+00 [OxD2=]
H1 = 8.000000e+00 [OxH1=]
H2 = 9.000000e+00 [OxH2=]
H3 = 1.000000e+01 [OxH3=]

```

General Setup Commands

DateTime=mmddyyyyhhmmss Set real-time clock month, day, year, hour, minute, and second.

Example: Set current date and time to 01 May 2014 12:05:00 (user input in bold).

datetime=05012014120500

Notes:

- The GPCTD baud (set with **BaudRate=**) must be the same as Seaterm232's baud (set in the Communications menu).
- **BaudRate=** must be sent twice. After the first entry, the GPCTD changes to the new baud, and then waits for the command to be sent again at the new baud (In the Communications menu, select *Configure*. In the dialog box, select the new baud and click OK. Then retype the command.). This prevents you from accidentally changing to a baud that is not supported by your computer. If it does not receive the command again at the new baud, it reverts to the previous baud.

BaudRate=x

x= baud rate (9600, 38400, or 115200). **Default 9600.** Check capability of your computer and terminal program before increasing baud; high baud requires a short cable and good PC serial port with accurate clock. **Command must be sent twice to change rate.**

RS232ForceOn=x

x=Y: RS-232 transceiver always enables Tx. Use this setting if providing 2-wire interface (ground and transmit) and setting **AutoRun=Y** (to start sampling when power applied).
x=N: RS-232 transceiver enables Tx only when Rx is valid. **Default.**

OutputExecutedTag=x

x=Y: Display XML Executing and Executed tags. Executed tag displays at end of each command response; Executing tag displays one or more times if GPCTD response to command requires additional time.

x=N: Do not.

Example: Set GPCTD to output Executed and Executing tags (user input in bold).

```
outputexecutedtag=y
<Executed/>getcd
. . . (GetCD response)
<Executed/>
```

(Note: <Executed/> tag at end of command response takes place of S> prompt.)

Note:

Output format does not affect how data is stored in FLASH memory.

Typical use of the output format command is:

- Before beginning sampling:
 - **If you will use Seaterm232 to view real-time data** - Set output format to converted decimal for ease in viewing real-time data.
 - **If you will use your controller to acquire real-time data** - Set output format as desired.
- After stopping sampling, use Seaterm232's Upload menu to upload data from memory. This automatically uploads data in a form that is compatible with SBE Data Processing for processing data.

OutputFormat=x

x= output format. See *Data Formats* after these command descriptions for complete details.

x=0: Output data in hexadecimal; converted (engineering units) data for pressure, temperature, conductivity, and frequency for dissolved oxygen.

x=1: Output data in decimal; converted (engineering units) data for pressure, temperature, conductivity, and frequency for dissolved oxygen.

x=2: Output data in decimal; raw data (frequencies and counts); for diagnostic use at Sea-Bird.

General Setup Commands *(continued)*

Note:

If your GPCTD is equipped with the optional DO sensor, and you want to save power by not measuring oxygen, set **OxygenInstalled=N** and **reroute the plumbing to provide a direct path from GPCTD to the pump and back to the GPCTD**. If you do not remove the DO sensor from the plumbing, the pump flow rate will be insufficient for the flow path.

OxygenInstalled=x

GPCTD requires verification when **OxygenInstalled=** is sent; command must be sent twice.

x=Y: SBE 43F dissolved oxygen sensor is installed; GPCTD provides power to DO sensor. For autonomous sampling and spot sampling (**PTS** command), **pump is run at fast speed** (supplying 5V to pump) because of DO sensor in flow path.

x=N: SBE 43F dissolved oxygen sensor is **not** installed. GPCTD does not provide power to DO sensor. For autonomous sampling and spot sampling (**PTS** command), **pump is run at slow speed** (supplying 4V to pump) because there is no DO sensor in flow path. See **CustomPumpMode=** below

Note:

CustomPumpMode= has no effect on operation if **OxygenInstalled=Y** (GPCTD is already operating pump at fast speed if oxygen is installed).

CustomPumpMode=x

x=Y: For autonomous sampling and spot sampling (**PTS** command), run pump at **fast speed**, supplying 5V to pump, regardless of whether **OxygenInstalled=Y** or **N**. This setting may be useful if flow path is unusually long, or if sampling near the surface and expecting many bubbles in flow.

x=N: Do not override pump setting defined by **OxygenInstalled=**.

Note: Using **CustomPumpMode=Y** adds to power draw when sampling CTP only; use following values instead of values in *Specifications* in *Section 2*:

Description of Glider Payload CTD -

Continuous sampling:

- CTP only, real-time = no: 220 mW
- CTP only, real-time = yes: 235 mW

Fast Interval sampling

- CTP only, real-time = no: $0.225 + \text{interval} * 0.113$ (Joules/measurement)
- CTP only, real-time = yes: $0.172 + \text{interval} * 0.153$ (Joules/measurement)

Slow Interval sampling

- CTP only, real-time = no: $1.812 + \text{interval} * 0.002$ (Joules/measurement)
- CTP only, real-time = yes: $1.728 + \text{interval} * 0.043$ (Joules/measurement)

Spot sampling

- CTP only: $2.34 + 0.043 \text{ W} * \text{sec}$ until next command (Joules/measurement)

Note:

The GPCTD enters quiescent state automatically (without sending **QS**) if it is not sampling and does not receive a command for 2 minutes.

QS

Quit session and place GPCTD in quiescent (sleep) state. Power to digital and analog electronics is turned off. Memory retention is not affected.

Autonomous Sampling Commands

Autonomous sampling directs the GPCTD to turn on the pump and sample conductivity, temperature, pressure, and optional oxygen at the user-set **Interval**.

The GPCTD pump is water lubricated; running it *dry* for an extended period of time will damage it. To prevent the pump from running dry while sampling in autonomous (Continuous or Interval) sampling mode, the GPCTD checks the raw conductivity frequency (Hz) from the last sample against the user-input minimum conductivity frequency (**MinCondFreq=**). If the raw conductivity frequency is greater than **MinCondFreq**, it runs the pump; otherwise it does not run the pump. If the minimum conductivity frequency is too close to the *zero conductivity frequency* (from the GPCTD Calibration Sheet), the pump may turn on when the GPCTD is in air, as a result of small drifts in the electronics. Some experimentation may be required to control the pump, particularly in fresh water applications.

Interval=x

x= interval (sec) between samples.

- x=1 – 4: GPCTD is in **Continuous Sampling mode**. Pump and all sampling circuitry remain on continuously; GPCTD samples every 1, 2, 3, or 4 sec. There is no power saving over 1 Hz (1/sec) sampling if sampling at 2, 3, or 4 sec intervals, but less memory is used.
- x = 5 – 14: GPCTD is in **Fast Interval Sampling mode**. Pump runs continuously, and measurements are made at chosen interval.
- x = 15 - 3600: GPCTD is in **Slow Interval Sampling mode** (CTD only; no DO measurements). Pump runs for 11.3 sec before each measurement, plus 2.1 sec during measurement. Pump turns off and CTD goes into low-power state between measurements.

MinCondFreq=x

x= minimum conductivity frequency (Hz) to enable pump turn-on for autonomous (Continuous or Interval) sampling, to prevent pump from running before GPCTD is in water. Pump does not run when conductivity frequency drops below **MinCondFreq=**. GPCTD Configuration Sheet lists uncorrected (raw) frequency output at 0 conductivity.

Typical value (and factory-set default) for **MinCondFreq=** for salt water and estuarine applications is:
(zero conductivity frequency + 500 Hz).

Typical value for **MinCondFreq=** for fresh water applications is:
(zero conductivity frequency + 5 Hz).

CAUTION:

The GPCTD **always** runs the pump in response to a Spot sampling pumped command (**PTS**), regardless of the conductivity frequency from the last sample and the setting for **MinCondFreq=**.

Notes:

- The GPCTD always outputs real-time data for Spot sampling.
- **TxRealTime** does not affect storing data to memory, but slightly increases current consumption.
- To capture real-time data to a file in Seaterm232, do the following *before* starting sampling:
 1. Click the Capture menu.
 2. Enter the desired file name in the dialog box. The *capture* status displays in the status bar at the bottom of the screen.

Note:

If the FLASH memory is filled to capacity, sampling continues, but excess data is not saved in memory (i.e., the GPCTD does not overwrite the data in memory).

Note:

Do not reset logging until all data has been uploaded. These commands do not delete data; they reset the data pointer. **If you accidentally reset logging before uploading**, recover data as follows:

1. Set **SetSampleNum=x**, where **x** is your estimate of number of samples in memory.
2. Upload data. If **x** is more than actual number of samples in memory, data for non-existent samples will be bad, random data. Review uploaded data file carefully and delete any bad data.
3. If desired, increase **x** and upload data again, to see if there is additional valid data in memory.

Note:

If you remove power before uploading data, you may lose up to 256 bytes of data in the RAM buffer (22 samples of CTP; 18 samples CTD and DO). See *Appendix I: Functional Description and Circuitry*.

Notes:

- You may need to send **Stop** several times to get the GPCTD to respond.
- You must stop autonomous sampling before uploading data.

Autonomous Sampling Commands (*continued*)**TxRealTime=x**

x=Y: Output real-time data while sampling autonomously (Continuous or Interval sampling). Data is transmitted immediately after it is sampled.

x=N: Do not output real-time data.

ResetLogging

Do not use unless all previous data has been uploaded. **ResetLogging** sets sample number and header number for first sample to 0. This resets GPCTD to start saving data to beginning of memory, overwriting previous data in memory and making entire memory available for recording. GPCTD requires verification when **ResetLogging** is sent; command must be sent twice.

SetSampleNum=x

x= sample number for last sample in memory. **SetSampleNum=0** is equivalent to **ResetLogging**. Typically only used to recover data if you accidentally initialize logging (using **ResetLogging**) before uploading all data. **Do not send SetSampleNum=0 until all data has been uploaded.**

AutoRun=x

x=Y: When power applied, start pump and start autonomous (Continuous or Interval) sampling automatically. When power removed, stop sampling and stop pump.

x=N: Wait for command when power applied.
Default.

Start

Start pump and start autonomous (Continuous or Interval) sampling.

Stop

Stop pump and stop autonomous sampling. Press Enter key before entering **Stop**.

Data Upload Commands

You must stop autonomous sampling before uploading data. For data output formats, see *Data Formats*.

Note:

If you remove power before uploading data, you may lose up to 256 bytes of data in the RAM buffer (22 samples of CTP; 18 samples CTD and DO). See *Appendix I: Functional Description and Circuitry*.

UCx

Upload cast **x**. First cast is cast 1.

Example: Upload cast 1 to a file (user input in bold).
(Click Capture menu and enter desired filename in dialog box.)
UC1

UH

Upload all headers.

Example: Upload all headers to a file (user input in bold).
(Click Capture menu and enter desired filename in dialog box.)

UH

GPCTD responds:

```
<Headers>
cast  1 17 Jul 2014 15:41:26 samples 1 to 14, int = 1, stop = stop cmd
cast  2 17 Jul 2014 16:34:09 samples 39 to 43, int = 1, stop = stop cmd
</Headers>
```

Spot Sampling Commands

These commands request a single sample (with the exception of TSN:x). The data is transmitted in real-time, and the **GPCTD does not store data from these commands in FLASH memory.**

CAUTION:

Sending **PTS** causes the pump to turn on. **Do not run the pump dry.** The pump is water lubricated; running it without water (except for very short periods) will damage it. If testing your system in dry conditions, fill the inside of the pump head with water via the pump exhaust tubing. This will provide enough lubrication to prevent pump damage during testing.

PTS

Run pump, take **1** sample of all parameters, transmit data in units defined by **OutputFormat=**, and turn pump off.

Length of time that pump runs:

If SBE 43F DO sensor **not** installed, pump runs for 11.3 sec before beginning to sample.

If SBE 43F DO sensor **installed**, oxygen sensor response time, and corresponding length of time pump needs to run before taking sample, is dependent on temperature and (to a lesser extent) pressure.

GPCTD takes *preliminary* measurement of T and P, uses those values to calculate pump time (but does not store T and P values in memory), runs pump, and then takes fresh measurement of all parameters. Pump time increases with decreasing T and increasing P. See *Spot Sampling in Sampling Modes* above for details on pumping time.

Note:

TS, **TSR**, and **TSN:x** do not automatically turn the pump on. To get data from a fresh sample, send **PumpFast** (if dissolved oxygen sensor in flow path) or **PumpSlow** (if no dissolved oxygen sensor in flow path) some time before sending **TS** or **TSR**, and then send **PumpOff** when the data has been received. See the CAUTION above about running the pump dry.

TS

Take **1** sample of all parameters and transmit data in units defined by **OutputFormat=**. This command **does not run pump before sampling.**

TSN:x

Take **x** samples of all parameters and transmit data in units defined by **OutputFormat=**. This command **does not run pump before sampling.**

TSR

Take **1** sample of all parameters and transmit **raw** data (temperature ttttt A/D counts, conductivity ccccc.ccc Hz, pressure pppppp A/D counts, pressure temperature qqqq A/D counts, optional oxygen oooo.oo Hz). This command **does not run pump before sampling.**

TP

Take **1** sample of pressure, and transmit data (ppppp.pp decibars). This command **does not run pump before sampling.**

SL

Send **last** sample of all parameters from buffer, and transmit data in units defined by **OutputFormat=**.

Note:

Data in the buffer is from the last sample taken, regardless of whether the sample was acquired with spot sampling or autonomous sampling. See *Memory in Appendix I: Functional Description and Circuitry.*

SLP

Send **last** sample of pressure data from buffer in decimal engineering units (ppppp.pp decibars).

Pump On/Off Commands

The pump runs automatically for autonomous sampling (Continuous and Interval) when the conductivity frequency exceeds **MinCondFreq**, and runs automatically for the **PTS** spot sampling command.

Use pump commands:

- Before sending **TS**, **TSR**, or **TSN**: spot sampling commands, or
- To test pump, or
- To remove sediment from inside conductivity cell, DO sensor plenum, and/or plumbing.

CAUTION:

Do not run the pump dry. The pump is water lubricated; running it without water will damage it. If briefly testing your system with the **PumpFast** or **PumpSlow** command in dry conditions, orient the GPCTD to provide an upright shape for the plumbing. Then fill the plumbing with water via the intake and exhaust. This will provide enough lubrication to prevent pump damage during brief testing.

PumpFast

Turn pump on at fast speed, supplying **5 V** to pump (appropriate voltage if there is an **SBE 43F DO sensor** plumbed in flow path). Used to test pump or to run it to remove sediment from inside conductivity cell, DO sensor plenum, and/or plumbing. **Pump runs continuously, drawing current.** Send **PumpOff** to stop.

Note that:

1. GPCTD does **not** check minimum conductivity frequency when user sends **PumpFast**.
2. **PumpFast** has no effect on pump operation while sampling.

PumpSlow

Turn pump on at slow speed, supplying **4 V** to pump (appropriate voltage if there is **no SBE 43F DO sensor** plumbed in flow path). Used to test pump or to run it to remove sediment from inside conductivity cell, DO sensor plenum, and/or plumbing. **Pump runs continuously, drawing current.** Send **PumpOff** to stop.

Note that:

1. GPCTD does **not** check minimum conductivity frequency when user sends **PumpSlow**.
2. **PumpSlow** has no effect on pump operation while sampling.

PumpOff

Turn pump off if it was turned on with **PumpFast** or **PumpSlow**. Note that **PumpOff** has no effect on pump operation while autonomous (Continuous or Interval) sampling.

Coefficients Commands

Use the commands listed below to modify a particular coefficient or date:

Note:

F = floating point number
S = string with no spaces

Temperature

TCalDate=S	S=calibration date
TA0=F	F=A0
TA1=F	F=A1
TA2=F	F=A2
TA3=F	F=A3

Conductivity

CCalDate=S	S=calibration date
CG=F	F=G
CH=F	F=H
CI=F	F=I
CJ=F	F=J
CPCor=F	F=pcor
CTCor=F	F=tcor
WBOTC=F	F=conductivity temperature

Pressure

PCalDate=S	S=calibration date
PA0=F	F=A0
PA1=F	F=A1
PA2=F	F=A2
PTempA0=F	F=pressure temperature a0
PTempA1=F	F=pressure temperature a1
PTempA2=F	F=pressure temperature a2
PTCA0=F	F=pressure temperature compensation a0
PTCA1=F	F=pressure temperature compensation a1
PTCA2=F	F=pressure temperature compensation a2
PTCB0=F	F=pressure temperature compensation b0
PTCB1=F	F=pressure temperature compensation b1
PTCB2=F	F=pressure temperature compensation b2
POffset=F	F=pressure offset (decibars)

Optional Oxygen

OSN=S	S=4-digit serial number (useful for identifying integrated oxygen sensor)
OCalDate=S	S=calibration date
OxSoc=F	F=Soc
OxTau20=F	F=Tau20 (Hz)
OxFOffset=F	F= offset (Hz)
OxA=F	F=A
OxB=F	F=B
OxC=F	F=C
OxE=F	F=E
OxD1=F	F=D1
OxD2=F	F=D2
OxH1=F	F=H1
OxH2=F	F=H2
OxH3=F	F=H3

Note:

The GPCTD always outputs Dissolved Oxygen as raw oxygen frequency. DO calibration coefficients are used only to create the configuration (.xmlcon) file when you upload data from memory. The .xmlcon file is used to process the data in SBE Data Processing (see *Uploading and Processing Data*).

Hardware Configuration Commands

The following commands are used to set manufacturing date, PCB serial numbers, PCB assembly numbers, and auxiliary channel sensor types and serial number, **at the factory (do not modify in the field)**.

SetMfgDate=	
SetPCBSerialNum1=	SetPCBAssembly1=
SetPCBSerialNum2=	SetPCBAssembly2=
SetPCBSerialNum3=	SetPCBAssembly3=
SetPCBSerialNum4=	SetPCBAssembly4=

Data Formats

Note:

The GPCTD's pressure sensor is an absolute sensor, so its **raw** output includes the effect of atmospheric pressure (14.7 psi).

As shown on the Calibration Sheet, Sea-Bird's calibration (and resulting calibration coefficients) is in terms of psia. However, when outputting pressure in **engineering units**, the GPCTD outputs pressure relative to the ocean surface (i.e., at the surface the output pressure is 0 decibars).

The GPCTD uses the following equation to convert psia to decibars:

$$\text{Pressure (db)} = [\text{pressure (psia)} - 14.7] * 0.689476$$

The GPCTD stores data in a compact machine code. Data is converted and output in the user-selected format without affecting data in memory. Because memory data remains intact until deliberately overwritten, you can upload in one format, then choose another format and upload again.

Output format is dependent on **OutputFormat= (0, 1, or 2)**.

The inclusion of oxygen data is dependent on the GPCTD configuration; if **OxygenInstalled=N**, the oxygen data is omitted, shortening the data string.

OutputFormat=0 (engineering units in Hex)

Data is output in the order listed, with no spaces or commas between the parameters. Shown with each parameter is the number of digits, and how to calculate the parameter from the data (use the decimal equivalent of the hex data in the equations).

pppppttttccccoooo

1. Pressure (decibars) = (ppppp / 100) - 10
2. Temperature (°C, ITS-90) = (tttt / 10,000) - 5
3. Conductivity (S/m) = (cccc / 100,000) - 0.05
4. Optional Oxygen (Hz) = ooooo / 10

Example: ppppttttcccc = 003EE463AA0139B

- Pressure = ppppp = 003EE (1006 decimal);
pressure (decibars) = (1006 / 100) - 10 = 0.06
- Temperature = tttt = 463AA (287658 decimal);
temperature (°C, ITS-90) = (287658 / 10,000) - 5 = 23.7658
- Conductivity = ccccc = 0139B (5019 decimal);
conductivity (S/m) = (5019 / 100,000) - 0.05 = 0.00019
- Oxygen = ooooo = 0C887 (51383 Decimal);
oxygen (Hz) = 51383 / 10 = 5138.30

OutputFormat=1 (engineering units in Decimal)

Data is output in the order listed, with a comma between each parameter. Shown with each parameter are the number of digits and the placement of the decimal point. Leading zeros are suppressed, except for one zero to the left of the decimal point.

ppppp.pp,ttt.tttt,cc.ccccc,ooooo.oo

1. Pressure (decibars) = ppppp.pp
2. Temperature (°C, ITS-90) = ttt.tttt
3. Conductivity (S/m) = cc.ccccc
4. Optional Oxygen (Hz) = ooooo.oo

Example: ppppp.pp,ttt.tttt,cc.ccccc = 0.06, 23.7658, 0.00019, 5138.30

- Pressure (decibars) = 0.06
- Temperature (°C, ITS-90) 23.7658
- Conductivity (S/m) = 0.00019
- Oxygen (Hz) = ooooo.oo = 5138.30

OutputFormat=2 (raw data in Decimal)

This format is used at Sea-Bird for calibration and diagnostics.

Data is output in the order listed. There is a comma and a space between each parameter. Shown with each parameter are the number of digits and the placement of the decimal point. Leading zeros are suppressed, except for one zero to the left of the decimal point.

ttttt, cccc.ccc, pppppp, vvvv, oooo.oo

1. Temperature (A/D counts) = ttttt
2. Conductivity (Hz) = cccc.ccc
3. Pressure (A/D counts) = pppppp
4. Pressure temperature (A/D counts) = vvvv
5. Optional Oxygen (Hz) = oooo.oo

Example: example scan = tttttt, cccc.ccc, pppppp, vvvv, oooo.oo
= 524372, 5970.384, 32768,2690, 5138.30

- Temperature (A/D counts) = ttttt = 524372
- Conductivity (Hz) = cccc.ccc = 5970.384
- Pressure (A/D counts) = pppppp = 32768
- Pressure temperature (A/D counts) = vvvv = 2690
- Oxygen (Hz) = oooo.o = 5138.30

Optimizing Data Quality

Position other sensors and hardware so that they do not thermally contaminate the water that flows past the GPCTD.

Route the plumbing (Tygon tubing from CTD to optional DO sensor, pump, and exhaust) to that it will not trap air.

Deployment/Recovery Technique and Pump Operation

The GPCTD's orientation and plumbing path, and good seals, combined with *optimal pump operation*, can prevent surface oils and other contaminants from getting into the plumbing, conductivity cell, and oxygen plenum. **These oils and contaminants are the primary cause of calibration drift in conductivity sensors and dissolved oxygen sensors.**

Proper deployment technique and pump operation to prevent intrusion of surface oils and contaminants follows:

1. On Deployment -
When not in use, store the GPCTD dry (see *Section 5: Routine Maintenance and Calibration*). Fill the plumbing system (conductivity cell, optional dissolved oxygen sensor, and plumbing) with clean water just before deployment. **Deploy the GPCTD without removing the water, holding the glider so that the GPCTD intake and exhaust are pointing up.** As the glider and GPCTD break the surface, oils and other surface contaminants will *float* on the water at the intake and exhaust, preventing contaminants from getting into the plumbing, conductivity cell, and DO plenum. Once the GPCTD is below the contaminated water surface layer and the controller sends the command to turn the pump on and sample, the GPCTD will expel any remaining water from the system and draw in seawater.
2. On Recovery -
Stop sampling to turn off the pump before the GPCTD reaches the surface. Hold the glider so that the GPCTD intake and exhaust are pointing up; seawater will be held in the plumbing. As the glider and GPCTD break the surface, oils and other surface contaminants will *float* on the seawater at the intake and exhaust, preventing contaminants from getting into the plumbing, conductivity cell, and DO plenum. Turn over the glider when it is on deck, emptying the seawater from the GPCTD's plumbing, so the oil floating on the intake and exhaust surfaces does not get into the system.

Deployment

Note:

The I/O cable is **not** included as part of the typical shipment, and must be ordered separately.

CAUTION:

Do not use WD-40 or other petroleum-based lubricants, as they will damage the connectors.

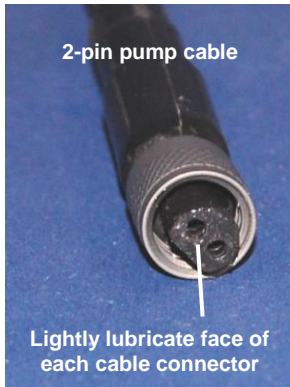

Note:

If you ordered the GPCTD without an SBE 43F DO sensor, the bulkhead connector for the DO sensor was not installed.

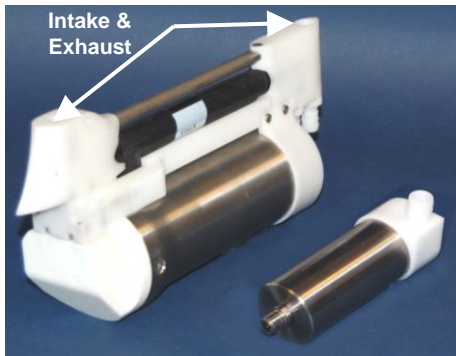

Prior to deployment, program the GPCTD for the intended application (see *Command Descriptions* above).

When you are ready to deploy the GPCTD:

1. Install the data I/O cable, pump, and optional DO sensor cable on the GPCTD:
 - A. Very lightly lubricate the face of the cable connector with silicone grease (DC-4 or equivalent).
 - B. Install the cable connector, aligning the pins.
 - C. Place the locking sleeve over the cable connector and tighten it finger tight only. **Do not overtighten the locking sleeve and do not use a wrench or pliers.**
2. Connect the other end of the 4-pin I/O cable to the GPCTD's controller and power supply.
3. Verify that all hardware and fittings are secure.
 - If deploying a GPCTD that has the optional DO connector without a DO sensor, verify that a dummy plug is installed in the optional oxygen sensor bulkhead connector on the GPCTD sensor end cap.
4. (If caps were placed on the end of the intake and exhaust to keep dust and debris out of the system during storage) Remove the caps from the end of the intake and exhaust.
5. See *Deployment/Recovery Technique and Pump Operation* in *Optimizing Data Quality* above for Sea-Bird recommendations on deployment and recovery techniques to minimize contamination of the conductivity cell and oxygen sensor membrane with surface oils as it enters/exits the water.
6. When ready to begin a profile:
 - (if **AutoRun=Y**) Apply power to begin sampling.
 - (if **AutoRun=N**) Apply power, send any character to wake up the GPCTD, and then send Start to begin sampling.

Recovery

WARNING!

If the GPCTD stops working while underwater, is unresponsive to commands, or shows other signs of flooding or damage, carefully secure it away from people until you have determined that abnormal internal pressure does not exist or has been relieved. Pressure housings may flood under pressure due to dirty or damaged o-rings, or other failed seals. When a sealed pressure housing floods at great depths and is subsequently raised to the surface, water may be trapped at the pressure at which it entered the housing, presenting a danger if the housing is opened before relieving the internal pressure. Instances of such flooding are rare. However, a housing that floods at 1500 meters depth holds an internal pressure of more than 2000 psia, and has the potential to eject the end cap with lethal force. A housing that floods at 50 meters holds an internal pressure of more than 85 psia; this force could still cause injury.

If you suspect the GPCTD is flooded, point it in a safe direction away from people, and loosen the 4 screws on the sensor end cap about ½ turn. If there is internal pressure, the end cap will *follow* the screws out, and the screws will not become easier to turn. In this event, loosen the bulkhead connector (on the other end cap) very slowly, at least 1 turn. This opens an o-ring seal under the connector. Look for signs of internal pressure (hissing or water leak). If internal pressure is detected, let it bleed off slowly past the connector o-ring. Then, you can safely remove the sensor end cap.

See *Deployment/Recovery Technique and Pump Operation in Optimizing Data Quality* above for Sea-Bird recommendations on orienting the GPCTD during recovery to minimize contamination of the conductivity cell and oxygen sensor membrane with surface oils.

Rinse the GPCTD with fresh water. See *Section 5: Routine Maintenance and Calibration* for conductivity cell and dissolved oxygen sensor rinsing, cleaning, and storage.

Uploading and Processing Data

*Note: For best performance and compatibility, Sea-Bird recommends that customers set their computer to English language format and the use of a period (.) for the decimal symbol. Some customers have found corrupted data when using the software's **binary upload** capability while set to other languages. To update your computer's language and decimal symbol (instructions are for a Windows 7 operating system):*

1. *In the computer Control Panel window, select Region and Language.*
2. *In the Region and Language window, on the Formats tab, select English in the Format pull down box.*
3. *In the Region and Language window, click the Additional settings . . . button. In the Customize Format window, select the period (.) in the Decimal symbol pull down box, and click OK.*
4. *In the Region and Language window, click OK.*

Proceed as follows:

1. Install a data I/O cable (4-pin IE55 to DB-9S with external power leads or battery snap), aligning the pins.
2. Double click on **SeatermV2.exe**. The main screen appears.
3. In the Instruments menu, select *SBE Glider Payload CTD*. **Seaterm232** opens.
4. Seaterm232 tries to automatically connect to the GPCTD. As it connects, it sends **GetHD** and displays the response. Seaterm232 also fills the Send Commands window with the correct list of commands for your GPCTD.

If there is no communication:

 - A. In the Communications menu, select *Configure*. The Serial Port Configuration dialog box appears. Select the Comm port and baud rate for communication, and click OK. Note that the factory-set baud rate is documented on the Configuration Sheet.
 - B. In the Communications menu, select *Connect* (if *Connect* is grayed out, select *Disconnect and reconnect*). Seaterm232 will attempt to connect at the baud specified in Step A, but if unsuccessful will then cycle through all other available baud rates.
 - C. If there is still no communication, check cabling between the computer and GPCTD.
 - D. If there is still no communication, repeat Step A with a different comm port, and try to connect again.
5. If sampling autonomously, command the GPCTD to stop logging by pressing the Enter key, typing **Stop**, and pressing the Enter key again.
6. Display GPCTD status information by typing **DS** and pressing the Enter key. The display looks like this:

```
SBE Glider Payload CTD 1.2.1 SERIAL NO. 12345 25 Sep 2013 09:38:22
vMain = 9.37, vLith = 3.04
autorun = no
samplenum = 13, free = 559227, profiles = 3
not logging
sample every 1 seconds
sample mode is continuous
data format = raw Decimal
do not force on RS232 transmitter
transmit real time data
acquire SBE 43 oxygen
minimum conductivity frequency = 3011.0
custom pump mode disabled
```

Verify that the status is **not logging**.

Notes:

- The I/O cable is **not** included as part of the typical shipment, and must be ordered separately.
- Connect the I/O cable as described in *Power and Communications Test* in Section 3: *Preparing GOCTD for Deployment*.

7. Click Upload menu to upload stored data. Seaterm232 responds as follows:
 - A. Seaterm232 sends several status commands and displays the responses, providing information on the instrument setup and number of samples and profiles in memory.
 - B. In the Save As dialog box, enter the desired upload file name and click OK. The upload file has a .XML extension.
 - C. An Upload Data dialog box appears:

Note:
If binary upload is selected, Seaterm232 uploads the data in binary and then converts it to ASCII text, resulting in a data file that is identical to one uploaded in ASCII text.

Select number of bytes uploaded in each block. Seaterm232 uploads data in blocks, and calculates a checksum at end of each block. If block fails checksum verification, Seaterm232 tries to upload block of data again, cutting block size in half.

Defines data upload type and range:

- All data as a single file – All data uploaded into 1 file.
- All data separated by cast – All data uploaded. Separate file is written for each cast, with 3-digit cast number (001, 002, etc.) appended to user-selected file name.
- By cast number range – Enter beginning cast number and total number of casts. Separate file is written for each cast, with 3-digit cast number (001, 002, etc.) appended to user-selected file name.
- By scan number range – Enter beginning scan (sample) number and total number of scans. All data within range is uploaded into 1 file.
- From a single cast – Enter cast number. All data is uploaded into 1 file.

(Oxygen section does not appear if GPCTD is not integrated with optional DO.) If *Apply hysteresis correction* selected, Seaterm232 performs hysteresis corrections on SBE 43F frequency values. See *Application Note 64-3* for hysteresis correction details.

To change upload file name selected in Step B above, click Browse to navigate to desired upload file path and name. Upload file has a .xml extension.

- After Seaterm232 uploads data into .xml file, it automatically converts .xml file to .cnv file (same file name, different extension), which is compatible with SBE Data Processing.
- Seaterm232 also creates a configuration file (same file name, .xmlcon extension), which contains information on GPCTD calibration coefficients. This file is used in SBE Data Processing's Derive module, for calculating derived variables.

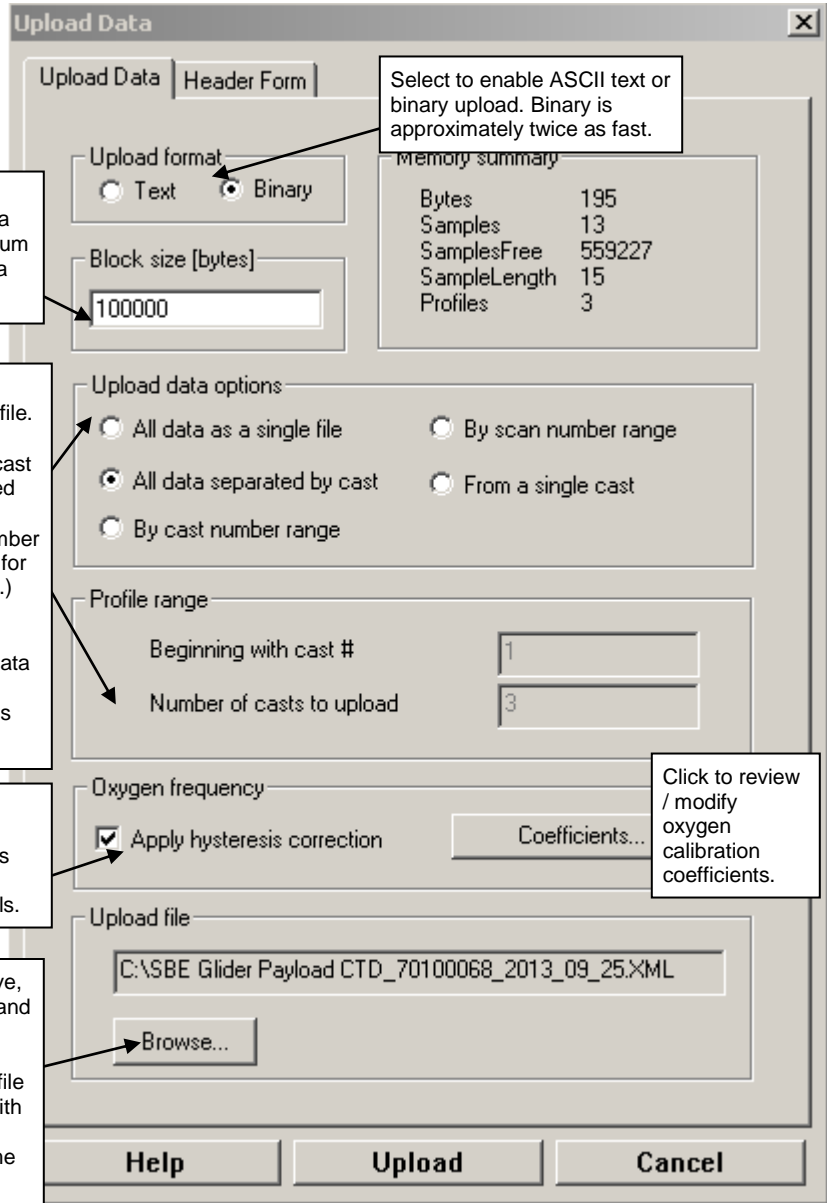

Make the desired selections.

8. Click the Header Form tab to customize the header:

Defines header information included with uploaded data:

- Prompt for header information – Each time data is uploaded, user is prompted to fill out user-defined header form.
- Include default header form in upload file – User-defined default header form included in upload file. User is not prompted to add any information when data is uploaded.
- Don't include default header form in upload file – Header information not included in upload file.

The entries are free form, 0 to 12 lines long. This dialog box establishes:

- the header prompts that appear for the user to fill in when uploading data, if *Prompt for header information* was selected
- the header included with the uploaded data, if *Include default header form in upload file* was selected

Enter the desired header/header prompts.

9. Click Upload; the Status bar at the bottom of the window displays the upload progress:

- Seaterm232 sends several status commands and writes the responses to the upload file. These commands provide information regarding the number of samples in memory, calibration coefficients, etc.
- If you selected *Prompt for header information in the Upload Data dialog box*** – a dialog box with the header form appears. Enter the desired header information, and click OK. Seaterm232 writes the header information to the upload file.
- Seaterm232 sends the data upload command, based on your selection of upload range in the Upload Data dialog box, writes the data to the upload .xml file, and then creates the .cnv file from the .xml file. The .cnv file is compatible with the post-processing modules in SBE Data Processing.
- If you selected *All data separated by cast or By cast number range in the Upload Data dialog box*** – Seaterm232 repeats Steps B and C for each cast.
- Seaterm232 creates a configuration (.xmlcon) file, which contains information on GPCTD calibration coefficients. This file is used in SBE Data Processing's Derive module.
- When the data has been uploaded, Seaterm232 shows the S> prompt (if **OutputExecutedTag=N**).

Note:

If you selected *Apply hysteresis correction* in the Upload Data dialog box, the oxygen frequency values in the .cnv file have been corrected for hysteresis.

10. Ensure all data has been uploaded from the GPCTD by reviewing the data in SBE Data Processing:

Notes:

- Dynamic errors in data acquired with Slow Interval Sampling or Spot Sampling cannot be improved by running Filter, Align CTD, or Cell Thermal Mass.
- See the SBE Data Processing manual on CD-ROM or the Help files for details on using the software to process data.

Notes:

To prepare for re-deployment:

1. After all data has been uploaded, send **ResetLogging**. If this is not sent, new data will be stored after the last recorded sample, preventing use of the entire memory capacity.
2. Do *one* of the following:
 - Send **QS** to put the GPCTD in quiescent (sleep) state until ready to redeploy. Quiescent current is only 30 microAmps.
 - Use **Start** to begin autonomous sampling.

- A. If you used Continuous Sampling or Fast Interval Sampling, you can use the Filter, Align CTD, and Cell Thermal Mass modules to reduce dynamic errors observed in the data.
- B. Use the Derive module to compute salinity, density, and other parameters.
 - 1) In SBE Data Processing's Run menu, select Derive.
 - 2) In the Derive dialog box, click on the File Setup tab. Select the configuration (.xmlcon) file and data (.cnv) file that were output by Seaterm232 in Step 9.
 - 3) Click on the Data Setup tab, and click Select Derived Variables. Select the desired output variables, and click OK. Then click Start Process. Derive will output a .cnv file that includes all the data in the input .cnv file as well as the desired derived variables.
- C. Use the Sea Plot module to plot the data.

Section 5: Routine Maintenance and Calibration

This section reviews corrosion precautions, connector mating and maintenance, conductivity cell storage and cleaning, pressure sensor maintenance, oxygen sensor maintenance, replacing AF24173 Anti-Foulant Devices, and sensor calibration. The accuracy of the GPCTD is sustained by the care and calibration of the sensors and by establishing proper handling practices.

Corrosion Precautions

Rinse the GPCTD with fresh water after use and prior to storage.

All exposed materials are titanium or plastic. No corrosion precautions are required, but direct electrical connection of the titanium to dissimilar metal hardware should be avoided.

Connector Mating and Maintenance

Note:

See *Application Note 57: Connector Care and Cable Installation*.

CAUTION:

Do not use WD-40 or other petroleum-based lubricants, as they will damage the connector.

Clean and inspect connectors, cables, and dummy plugs before every deployment and as part of your yearly equipment maintenance. Inspect connectors that are unmated for signs of corrosion product around the pins, and for cuts, nicks or other flaws that may compromise the seal.

When remating:

1. Very lightly lubricate the face of the dummy plug / cable connector with silicone grease (DC-4 or equivalent).
2. Install the dummy plug/cable connector, aligning the pins.
3. Place the locking sleeve over the plug/cable connector. Tighten the locking sleeve finger tight only. **Do not overtighten the locking sleeve and do not use a wrench or pliers.**

Verify that cables are installed before deployment.

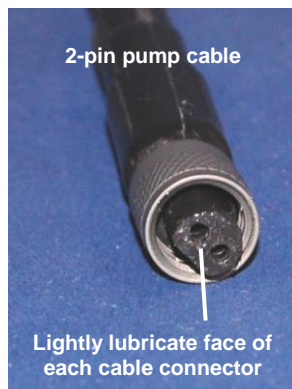

Conductivity Cell Maintenance

CAUTIONS:

- **Do not put a brush or any object inside the conductivity cell to dry it or clean it.** Touching and bending the electrodes can change the calibration. Large bends and movement of the electrodes can damage the cell.
- **Do not store the GPCTD with water in the conductivity cell.** Freezing temperatures (for example, in Arctic environments or during air shipment) can break the cell if it is full of water.

The GPCTD's conductivity cell is shipped dry to prevent freezing in shipping. Refer to *Application Note 2D: Instructions for Care and Cleaning of Conductivity Cells* for rinsing, cleaning, and storage procedures and materials.

Pressure Sensor Maintenance

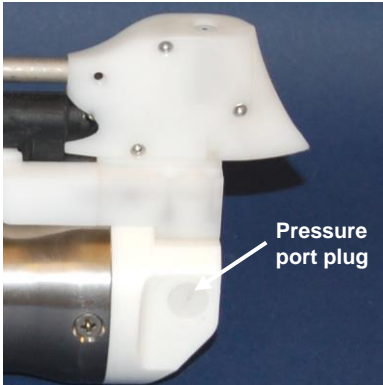

The pressure port plug has a small vent hole to allow hydrostatic pressure to be transmitted to the pressure sensor inside the instrument, while providing protection for the pressure sensor, keeping most particles and debris out of the pressure port.

Periodically (approximately once a year) inspect the pressure port to remove any particles, debris, etc.:

1. Unscrew the pressure port plug from the pressure port.
2. Rinse the pressure port with warm, de-ionized water to remove any particles, debris, etc.
3. Replace the pressure port plug.

CAUTION:

Do not put a brush or any object in the pressure port. Doing so may damage or break the pressure sensor.

Oxygen Sensor Maintenance

CAUTIONS:

- **Do not use a brush or any object on the oxygen sensor membrane to clean it,** as you may tear it.
- **Do not store the GPCTD with water in the oxygen sensor plenum.** Freezing temperatures (for example, in Arctic environments or during air shipment) can tear the membrane if the plenum is full of water.

Refer to *Application Note 64: Dissolved Oxygen Sensor – Background Information, Deployment Recommendations, and Cleaning and Storage* for rinsing, cleaning, and storage procedures and materials for the optional oxygen sensor.



Replacing Anti-Foulant Devices – Mechanical Design Change

The T-C Duct also serves as the anti-foulant device fitting.

The following page, developed for an SBE 37-SM MicroCAT, provides details on handling the Anti-Foulant Device. However, those mechanical details for accessing the Anti-Foulant Device are not valid for the GPCTD. Follow these instructions to access the Anti-Foulant Device

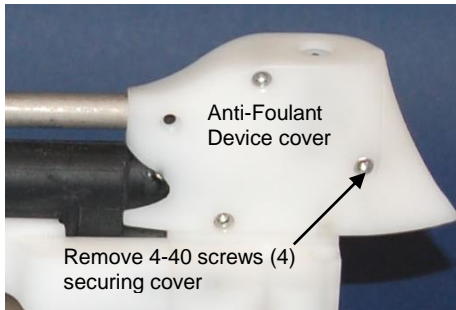

1. Using an Allen wrench, remove the four 4-40 screws securing the Anti-Foulant Device cover. Pull the cover off.
2. Replace the Anti-Foulant Device in the *cup* around the temperature sting.
3. Replace the cover, reinstalling the four 4-40 screws.

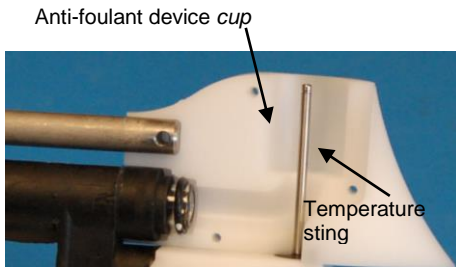

Replacing Anti-Foulant Devices (SBE 37-SI, SM, IM)



AF24173
Anti-Foulant
Device

The MicroCAT has an anti-foulant device cup and cap on each end of the cell. New MicroCATs are shipped with an Anti-Foulant Device and a protective plug pre-installed in each cup.

WARNING!

AF24173 Anti-Foulant Devices contain bis(tributyltin) oxide. Handle the devices only with rubber or latex gloves. Wear eye protection. Wash with soap and water after handling.

Read precautionary information on product label (see Appendix III) before proceeding.

It is a violation of US Federal Law to use this product in a manner inconsistent with its labeling.

Wearing rubber or latex gloves, follow this procedure to replace each Anti-Foulant Device (two):

1. Remove the protective plug from the anti-foulant device cup;
2. Unscrew the cap with a $\frac{5}{8}$ -inch socket wrench;
3. Remove the old Anti-Foulant Device. If the old device is difficult to remove:

- Use needle-nose pliers and carefully break up material;
- If necessary, remove the guard to provide easier access.

Place the new Anti-Foulant Device in the cup;

4. Rethread the cap onto the cup. Do not over tighten;
5. If the MicroCAT is to be stored, reinstall the protective plug. **Note that the plugs must be removed prior to deployment or pressurization.** If the plugs are left in place during deployment, the cell will not register conductivity. If left in place during pressurization, the cell may be destroyed.

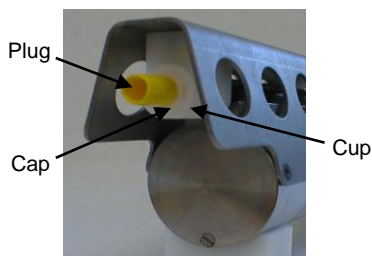
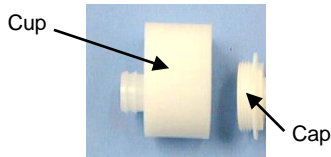

CAUTION:

Anti-foulant device cups are attached to the guard and connected with tubing to the cell. **Removing the guard without disconnecting the cups from the guard will break the cell.** If the guard must be removed:

1. Remove the two screws connecting each anti-foulant device cup to the guard.
2. Remove the four Phillips-head screws connecting the guard to the housing and sensor end cap.
3. Gently lift the guard away.

Sensor Calibration

Note:

After recalibration, Sea-Bird enters the new conductivity, temperature, pressure, and optional oxygen calibration coefficients in the GPCTD's EEPROM, and ships the instrument back to the user with Calibration Certificates showing the new coefficients.

Sea-Bird sensors are calibrated by subjecting them to known physical conditions and measuring the sensor responses. Coefficients are then computed, which may be used with appropriate algorithms to obtain engineering units. The conductivity, temperature, pressure, and optional oxygen sensors on the GPCTD are supplied fully calibrated, with coefficients stored in EEPROM in the GPCTD and printed on their respective Calibration Certificates.

We recommend that the GPCTD be returned to Sea-Bird for calibration.

Conductivity Sensor Calibration

The conductivity sensor incorporates a fixed precision resistor in parallel with the cell. When the cell is dry and in air, the sensor's electrical circuitry outputs a frequency representative of the fixed resistor. This frequency is recorded on the Calibration Certificate and should remain stable (within 1 Hz) over time.

The primary mechanism for calibration drift in conductivity sensors is the fouling of the cell by chemical or biological deposits. Fouling changes the cell geometry, resulting in a shift in cell constant.

Accordingly, the most important determinant of long-term sensor accuracy is the cleanliness of the cell. We recommend that the conductivity sensor be calibrated before and after deployment, but particularly when the cell has been exposed to contamination by oil slicks or biological material.

Temperature Sensor Calibration

The primary source of temperature sensor calibration drift is the aging of the thermistor element. Sensor drift will usually be a few thousandths of a degree during the first year, and less in subsequent intervals. Sensor drift is not substantially dependent upon the environmental conditions of use, and — unlike platinum or copper elements — the thermistor is insensitive to shock.

Pressure Sensor Calibration

The GPCTD's strain-gauge pressure sensor is capable of meeting the GPCTD's error specification with some allowance for aging and ambient-temperature induced drift.

Pressure sensors show most of their error as a linear offset from zero. A technique is provided below for making small corrections to the pressure sensor calibration using the *offset* (**POffset=**) calibration coefficient term by comparing GPCTD pressure output to readings from a barometer.

Allow the GPCTD to equilibrate (with power on) in a reasonably constant temperature environment for at least 5 hours before starting. Pressure sensors exhibit a transient change in their output in response to changes in their environmental temperature. Sea-Bird instruments are constructed to minimize this by thermally decoupling the sensor from the body of the instrument. However, there is still some residual effect; allowing the GPCTD to equilibrate before starting will provide the most accurate calibration correction.

Note:

The GPCTD's pressure sensor is an absolute sensor, so its **raw** output includes the effect of atmospheric pressure (14.7 psi). As shown on the Calibration Sheet, Sea-Bird's calibration (and resulting calibration coefficients) is in terms of psia. However, when outputting pressure in **engineering units**, the GPCTD outputs pressure relative to the ocean surface (i.e., at the surface the output pressure is 0 decibars). The GPCTD uses the following equation to convert psia to decibars:
 Pressure (db) =
 [pressure (psia) - 14.7] * 0.689476

1. Place the GPCTD in the orientation it will have when deployed.
2. In Seaterm232:
 - A. Set the pressure offset to 0.0 (**POffset=0**).
 - B. Send **OutputFormat=1** to set the output format to decimal engineering units.
 - C. Send **TSN:100** to sample 100 times and transmit converted data in engineering units (decibars for pressure).
3. Compare the GPCTD output to the reading from a good barometer at the same elevation as the GPCTD's pressure sensor.
 Calculate *offset* = barometer reading – GPCTD reading
4. Enter calculated offset (positive or negative) in the GPCTD's EEPROM, using **POffset=** in Seaterm232.

Offset Correction Example

Absolute pressure measured by a barometer is 1010.50 mbar. Pressure displayed from GPCTD is -2.5 db.

Convert barometer reading to decibars using the relationship: mbar * 0.01 = db

Barometer reading = 1010.50 mbar * 0.01 = 10.1050 db

The GPCTD's internal calculations and our processing software output gage pressure, using an assumed value of 14.7 psi for atmospheric pressure. Convert GPCTD reading from gage to absolute by adding 14.7 psia to the GPCTD's output:

-2.5 db + (14.7 psi * 0.689476 db/psia) = -2.5 + 10.13 = 7.635 db

Offset = 10.1050 – 7.635 = + 2.47 db

Enter offset in GPCTD.

For demanding applications, or where the sensor's air ambient pressure response has changed significantly, calibration using a dead-weight generator is recommended. This provides more accurate results, but requires equipment that may not be readily available. The end cap's ⁷/₁₆-20 straight thread permits mechanical connection to the pressure source. Use a fitting that has an O-ring tapered seal, such as Swagelok-200-1-4ST, which conforms to MS16142 boss.

Oxygen Sensor Calibration

The optional oxygen sensor measures the flux of oxygen across a Teflon membrane. The primary mechanism for calibration drift is the fouling of the membrane by chemical or biological deposits. Fouling changes the membrane permeability, resulting in a calibration shift. Accordingly, the most important determinant of long-term sensor accuracy is the cleanliness of the membrane. We recommend that the oxygen sensor be calibrated before and after deployment, but particularly when the sensor has been exposed to contamination by oil slicks or biological material.

A technique is provided in *Application Note 64-2: Dissolved Oxygen Sensor Calibration and Data Corrections using Winkler Titrations* for making small corrections to the oxygen sensor calibration by comparing oxygen output to Winkler titrations from water samples. This application note was written for an SBE 43 Dissolved Oxygen Sensor, a voltage output sensor, incorporated with a profiling CTD integrated with a water sampler. However, the basic technique can be adapted for use with the GPCTD, which incorporates the SBE 43F, a frequency output version of the SBE 43.

Section 6: Troubleshooting

This section reviews common problems in operating the GPCTD, and provides the most likely causes and solutions.

Problem 1: Unable to Communicate with GPCTD

If **OutputExecutedTag=N**, the S> prompt indicates that communications between the GPCTD and computer have been established. Before proceeding with troubleshooting, attempt to establish communications again by clicking Connect on SEATERM's toolbar or sending any character.

Cause/Solution 1: The I/O cable connection may be loose. Check the cabling between the GPCTD and computer for a loose connection.

Cause/Solution 2: The instrument type and/or its communication settings may not have been entered correctly in Seaterm232. Verify the settings in the Serial Port Configuration dialog box (Communications menu -> *Configure*). The settings should match those on the instrument Configuration Sheet.

Cause/Solution 3: The I/O cable may not be the correct one or may not be wired properly to the controller.

Problem 2: Unreasonable Data

The symptom of this problem is data that contains unreasonable values (for example, values that are outside the expected range of the data).

Cause/Solution 1: Conductivity, temperature, pressure, or optional oxygen data with unreasonable values may be caused by incorrect calibration coefficients in the instrument's EEPROM. Verify the calibration coefficients in EEPROM match the instrument Calibration Certificates, using the **DC** command.

Problem 3: Salinity Lower than Expected

Cause/Solution 1: A fouled conductivity cell will report lower than correct salinity. Large errors in salinity indicate that the cell is extremely dirty, has something large lodged in it, or is broken. Proceed as follows:

1. Clean the conductivity cell as described in *Application Note 2D: Instructions for Care and Cleaning of Conductivity Cells*.
2. Remove larger droplets of water by blowing through the conductivity cell. **Do not use compressed air**, which typically contains oil vapor.
3. Running the GPCTD in air, use the **TSR** command to look at the raw conductivity frequency (the second number in each line of output). It should be within 1 Hz of the zero conductivity value printed on the conductivity cell Calibration Sheet. If it is significantly different, the cell is probably damaged.

Glossary

GPCTD (Glider Payload CTD) - High-accuracy conductivity, temperature, pressure, and optional dissolved oxygen sensor.

Fouling – Biological growth in the conductivity cell and/or on the oxygen sensor membrane during deployment.

PCB – Printed Circuit Board.

SBE Data Processing – Sea-Bird’s Windows data processing software, which calculates and plots temperature, conductivity, pressure, data from auxiliary sensors, and derived variables such as salinity and sound velocity.

Scan – One data sample containing temperature, conductivity, pressure, and optional oxygen.

Seasoft V2 – Sea-Bird’s complete Windows software package, which includes software for communication, real-time data acquisition, and data analysis and display. Seasoft V2 includes Deployment Endurance Calculator, *SeatermV2*, *Seaterm*, *Seasave V7*, and *SBE Data Processing*. Note that the real-time data acquisition software is not compatible with the GPCTD.

SeatermV2 – Windows terminal program *launcher*. Depending on the instrument selected, it launches *Seaterm232* (RS-232 instruments, like the GPCTD), *Seaterm485* (RS-485 instruments), or *SeatermIM* (inductive modem instruments).

Seaterm232 – Windows terminal program used with Sea-Bird instruments that communicate via an RS-232 interface, and that were developed or redesigned in 2006 and later. The common feature of these instruments is the ability to output data in XML.

Super O-Lube – Silicone lubricant used to lubricate O-rings and O-ring mating surfaces. Super O-lube can be ordered from Sea-Bird, but should also be available locally from distributors. Super O-Lube is manufactured by Parker Hannifin (www.parker.com/ead/cm2.asp?cmid=3956).

Triton X-100 – Reagent grade non-ionic surfactant (detergent), used for cleaning the conductivity cell. Triton can be ordered from Sea-Bird, but should also be available locally from chemical supply or laboratory products companies. Triton is manufactured by Avantor Performance Materials (www.avantormaterials.com/commerce/product.aspx?id=2147509608).

Note:

All Sea-Bird software listed was designed to work with a computer running Windows XP service pack 2 or later, Windows Vista, or Windows 7 (32-bit or 64-bit).

CAUTION:

Do not use Parker O-Lube, which is petroleum based; use only Super O-Lube.

Appendix I: Functional Description and Circuitry

Sensors and Sensor Interface

Sensors:

- The GPCTD embodies the same temperature and conductivity sensor elements (pressure-protected thermistor and 3-electrode, 2-terminal, borosilicate glass cell) previously employed in Sea-Bird's MicroCAT and Argo float products.
- The pressure sensor is a Druck strain-gauge sensor.
- The optional oxygen sensor is the SBE 43F, a frequency-output version of the SBE 43 Dissolved Oxygen Sensor (voltage output sensor).

Sensor interfaces:

- Temperature is acquired by applying an AC excitation to a bridge circuit containing an ultra-stable aged thermistor with a drift rate of less than 0.002 °C per year. The other elements in the bridge are VISHAY precision resistors. A 24-bit A/D converter digitizes the output of the bridge. AC excitation and ratiometric comparison avoids errors caused by parasitic thermocouples, offset voltages, leakage currents, and reference errors.
- Conductivity is acquired using an ultra-precision Wien-Bridge oscillator to generate a frequency output in response to changes in conductivity.
- Pressure is acquired by applying an AC excitation to the pressure bridge. A 24-bit A/D converter digitizes the output of the bridge. AC excitation and ratiometric comparison avoids errors caused by parasitic thermocouples, offset voltages, leakage currents, and reference errors. A silicon diode embedded in the pressure bridge is used to measure the temperature of the pressure bridge. This temperature is used to perform offset and span corrections on the measured pressure signal.

Memory

The GPCTD has an 8-Mbyte non-volatile FLASH memory. FLASH memory is non-volatile; data in FLASH is not lost as a result of removal of power. Because FLASH is written to a *page* (256 bytes) at a time, data is first accumulated in a 256-byte RAM buffer. When the buffer is full, its contents are transferred to FLASH. The buffer is volatile, and thus depends on external power; any data that is in the buffer when power is removed will be corrupted. C, T, and P are stored in 12 bytes/sample; optional DO adds 3 bytes/sample. Thus, the 256-byte buffer can hold 22 samples of C, T, and P, or 18 samples of C, T, P, and DO; this is the maximum amount of data that will be corrupted each time power is removed.

Example 1: You stop logging, do not upload data, and remove power when there are 240,000 bytes in FLASH and 100 bytes in buffer. When you apply power and resume logging, GPCTD fills remaining 156 bytes in buffer with new data, writes entire buffer to FLASH, and continues logging and writing data to buffer. The 100 bytes that were in buffer when power was removed is corrupted; data before it (from first deployment) and data after it (from second deployment) are unaffected.

Example 2: You stop logging and upload data when there are 240,000 bytes in FLASH and 100 bytes in buffer. The GPCTD correctly uploads data in FLASH as well as data in buffer. You remove power after upload is complete.

Appendix II: Command Summary

CATEGORY	COMMAND	DESCRIPTION
Status	GetCD	Get and display configuration data (setup parameters).
	GetSD	Get and display status data
	GetCC	Display calibration coefficients.
	GetEC	Get and display event counter data.
	ResetEC	Delete all events in event counter.
	GetHD	Get and display hardware data.
	DS	Get and display status and setup parameters.
	DC	Get and display calibration coefficients.
General Setup	DateTime=mmddyyyyhhmmss	Set real-time clock month, day, year, hour, minute, second.
	BaudRate=x	x= baud rate (9600, 38400, or 115200). <i>Default 9600.</i>
	RS232ForceOn=x	x=Y: RS-232 transceiver always enables Tx. Use if providing 2-wire interface (ground and transmit) and setting AutoRun=Y . x=N: RS-232 transceiver enables Tx only when Rx is valid. <i>Default.</i>
	OutputExecutedTag=x	x=Y: Display XML Executing and Executed tags. x=N: Do not.
	OutputFormat=x	x=0: output converted data in Hex. x=1: output converted data in decimal. x=2: output raw data in decimal.
	OxygenInstalled=x	x=Y: SBE 43F dissolved oxygen sensor installed. x=N: SBE 43F dissolved oxygen sensor not installed.
	CustomPumpMode=x	x=Y: Run pump at fast speed, even if OxygenInstalled=N . x=N: Do not override pump setting defined by OxygenInstalled= .
Autonomous Sampling	QS	Quit session and place GPCTD in quiescent (sleep) state. Power to digital and analog electronics is turned off. Memory retention is not affected.
	Interval=x	x= interval (sec) between samples (1 - 3600).
	MinCondFreq=x	x= minimum conductivity frequency (Hz) to enable pump turn-on.
	TxRealTime=x	x=Y: Output real-time data for autonomous sampling. x=N: Do not.
	ResetLogging	Make entire memory available for recording.
	SetSampleNum=x	x= sample number for last sample in memory. SetSampleNum=0 is equivalent to ResetLogging .
	AutoRun=x	x=Y: Start pump and start sampling when power applied; stop sampling when power removed. x=N: Wait for a command when power applied.
	Start	Start pump and start autonomous sampling.
Data Upload	Stop	Stop pump and autonomous sampling. Press Enter key before sending Stop .
	UCx	Upload cast x . First cast is cast 1.
Spot Sampling	UH	Upload all headers.
	PTS	Run pump ; take 1 sample of all parameters; transmit data in units defined by OutputFormat= , and turn pump off. If DO sensor installed, time that pump runs is dependent on T and P.
	TS	Take 1 sample of all parameters; transmit data in units defined by OutputFormat= . Does not run pump before sampling . If desired, send a <i>pump command</i> before and after sending TS , to turn pump on and off.
	TSR	Take 1 sample of all parameters; transmit raw data. Does not run pump before sampling . If desired, send a <i>pump command</i> before and after TSR , to turn pump on and off.
	TP	Take 1 pressure sample, transmit data (ppppp.pp db).
	SL	Send last sample of all parameters from buffer and transmit data in units defined by OutputFormat= .
	SLP	Send last sample of pressure data from buffer in decimal engineering units (ppppp.pp db).

CATEGORY	COMMAND	DESCRIPTION
Pump On/Off	PumpFast	Turn pump on at fast speed.
	PumpSlow	Turn pump on at slow speed.
	PumpOff	Turn pump off.
Coefficients (F=floating point number; S=string with no spaces) Dates shown are when calibrations were performed. Calibration coefficients are initially factory-set and should agree with Calibration Certificates shipped with GPCTD.	TCalDate=S	S=Temperature calibration date.
	TAO=F	F=Temperature A0.
	TA1=F	F=Temperature A1.
	TA2=F	F=Temperature A2.
	TA3=F	F=Temperature A3.
	CCalDate=S	S=Conductivity calibration date.
	CG=F	F=Conductivity G.
	CH=F	F=Conductivity H.
	CI=F	F=Conductivity I.
	CJ=F	F=Conductivity J.
	CPCor=F	F=Conductivity pcor.
	CTCor=F	F=Conductivity tcor.
	WBOTC=F	F=Conductivity circuit temperature correction.
	PCalDate=S	S=Pressure calibration date.
	PA0=F	F=Pressure A0.
	PA1=F	F=Pressure A1.
	PA2=F	F=Pressure A2.
	PTempA0=F	F=Pressure temperature A0.
	PTempA1=F	F=Pressure temperature A1.
	PTempA2=F	F=Pressure temperature A2.
	PTCA0=F	F=Pressure temperature compensation ptca0.
	PTCA1=F	F=Pressure temperature compensation ptca1.
	PTCA2=F	F=Pressure temperature compensation ptca2.
	PTCB0=F	F=Pressure temperature compensation ptcb0.
	PTCB1=F	F=Pressure temperature compensation ptcb1.
	PTCB2=F	F=Pressure temperature compensation ptcb2.
	POffset=F	F=Pressure offset correction (decibars).
	OSN=S	S=4-digit oxygen sensor serial number.
	OCalDate=S	S=Oxygen calibration date.
	OxSoc=F	F=Oxygen SOC.
	OxTau20=F	F=Oxygen Tau20.
	OxFOffset=F	F=Oxygen offset (Hz).
	OxA=F	F=Oxygen A.
OxB=F	F=Oxygen B.	
OxC=F	F=Oxygen C.	
OxE=F	F=Oxygen E.	
OxD1=F	F=Oxygen D1.	
OxD2=F	F=Oxygen D2.	
OxH1=F	F=Oxygen H1.	
OxH2=F	F=Oxygen H2.	
OxH3=F	F=Oxygen H3.	
Hardware Configuration	SetMfgDate=	Set manufacturing date.
	SetPCBSerialNum1=	Set PCB #1 serial number.
	SetPCBSerialNum2=	Set PCB #2 serial number.
	SetPCBSerialNum3=	Set PCB #3 serial number.
	SetPCBSerialNum4=	Set PCB #4 serial number.
	SetPCBAssembly1=	Set PCB #1 assembly number.
	SetPCBAssembly2=	Set PCB #2 assembly number.
	SetPCBAssembly3=	Set PCB #3 assembly number.
	SetPCBAssembly4=	Set PCB #4 assembly number.

Appendix III: AF24173 Anti-Foulant Device

AF24173 Anti-Foulant Devices supplied for user replacement are supplied in polyethylene bags displaying the following label:

AF24173 ANTI-FOULANT DEVICE

FOR USE ONLY IN SEA-BIRD ELECTRONICS' CONDUCTIVITY SENSORS TO CONTROL THE GROWTH OF AQUATIC ORGANISMS WITHIN ELECTRONIC CONDUCTIVITY SENSORS.

ACTIVE INGREDIENT:

Bis(tributyltin) oxide..... 52.1%

OTHER INGREDIENTS: 47.9%

Total..... 100.0%

DANGER

See the complete label within the Conductivity Instrument Manual for Additional Precautionary Statements and Information on the Handling, Storage, and Disposal of this Product.

Net Contents: Two anti-foulant devices.

Sea-Bird Electronics, Inc.
13431 NE 20th Street
Bellevue, WA 98005

EPA Registration No. 74489-1
EPA Establishment No. 74489-WA-1

AF24173 Anti-Foulant Device

FOR USE ONLY IN SEA-BIRD ELECTRONICS' CONDUCTIVITY SENSORS TO CONTROL THE GROWTH OF AQUATIC ORGANISMS WITHIN ELECTRONIC CONDUCTIVITY SENSORS.

ACTIVE INGREDIENT:

Bis(tributyltin) oxide.....	52.1%
OTHER INGREDIENTS:	<u>47.9%</u>
Total.....	100.0%

DANGER

See Precautionary Statements for additional information.

FIRST AID	
If in eyes	<ul style="list-style-type: none"> • Hold eye open and rinse slowly and gently with water for 15-20 minutes. • Remove contact lenses, if present, after the first 5 minutes, then continue rinsing eye. • Call a poison control center or doctor for treatment advice.
If on skin or clothing	<ul style="list-style-type: none"> • Take off contaminated clothing. • Rinse skin immediately with plenty of water for 15-20 minutes. • Call a poison control center or doctor for treatment advice.
If swallowed	<ul style="list-style-type: none"> • Call poison control center or doctor immediately for treatment advice. • Have person drink several glasses of water. • Do not induce vomiting. • Do not give anything by mouth to an unconscious person.
HOT LINE NUMBER	
Note to Physician	Probable mucosal damage may contraindicate the use of gastric lavage
Have the product container or label with you when calling a poison control center or doctor, or going for treatment. For further information call National Pesticide Telecommunications Network (NPTN) at 1-800-858-7378.	

Net Contents: Two anti-foulant devices

Sea-Bird Electronics, Inc.
13431 NE 20th Street
Bellevue, WA 98005

EPA Registration No. 74489-1
EPA Establishment No. 74489-WA-1

PRECAUTIONARY STATEMENTS

HAZARD TO HUMANS AND DOMESTIC ANIMALS

DANGER

Corrosive - Causes irreversible eye damage and skin burns. May be fatal if swallowed or absorbed through the skin. Do not get in eyes, on skin, or on clothing. Wash thoroughly with soap and water after handling and before eating, drinking, chewing gum, using tobacco, or using the toilet. Remove and wash contaminated clothing before reuse.

PERSONAL PROTECTIVE EQUIPMENT

Users must wear: protective gloves (rubber or latex), goggles or other eye protection, long-sleeved shirt, long pants, and shoes plus socks.

USER SAFETY RECOMMENDATIONS

Users should:

- Remove clothing immediately if pesticide gets inside. Then wash thoroughly and put on clean clothing.
- Follow manufacturer's instructions for cleaning and maintaining PPE. If no such instructions for washables, use detergent and hot water. Keep and wash PPE separately from other laundry.

ENVIRONMENTAL HAZARDS

Do not discharge effluent containing this product into lakes, streams, ponds, estuaries, oceans, or other waters unless in accordance with the requirements of a National Pollutant Discharge Elimination System (NPDES) permit and the permitting authority has been notified in writing prior to discharge. Do not discharge effluent containing this product to sewer systems without previously notifying the local sewage treatment plant authority. For guidance contact your State Water Board or Regional Office of EPA. This material is toxic to fish and aquatic invertebrates. Do not contaminate water when cleaning equipment or disposing of equipment washwaters.

PHYSICAL OR CHEMICAL HAZARDS

Do not use or store near heat or open flame. Avoid contact with acids and oxidizers.

DIRECTIONS FOR USE

It is a violation of Federal Law to use this product in a manner inconsistent with its labeling.

For use only in Sea-Bird Electronics' conductivity sensors. Read installation instructions in the applicable Conductivity Instrument Manual.

Intended for professional use by military, government, academic, commercial, and scientific personnel.

STORAGE AND DISPOSAL

PESTICIDE STORAGE: Store in original container in a cool, dry place. Prevent exposure to heat or flame. Do not store near acids or oxidizers. Keep container tightly closed.

PESTICIDE SPILL PROCEDURE: In case of a spill, absorb spills with absorbent material. Put saturated absorbent material to a labeled container for treatment or disposal.

PESTICIDE DISPOSAL: Pesticide that cannot be used according to label instructions must be disposed of according to Federal or approved State procedures under Subtitle C of the Resource Conservation and Recovery Act.

CONTAINER HANDLING: Nonrefillable container. Do not reuse this container for any other purpose. Offer for recycling, if available.

Appendix IV: Replacement Parts

Part Number	Part	Application Description	Quantity in GPCTD
801944	4-pin IE55 to DB-9S with power leads, 2.5 m (9 ft)	From bulkhead connector on GPCTD to computer for setup and data upload	-
172581	2-pin IE55 to 2-pin IE55 cable, 0.5 m (1.75 ft)	From pump to bulkhead connector on GPCTD sensor end cap	1
171558	3-pin IE55 to 3-pin IE55 cable, 0.5 m (1.75 ft)	From dissolved oxygen sensor to optional oxygen bulkhead connector on GPCTD sensor end cap	-
30411	Triton X-100	Octyl Phenol Ethoxylate – Reagent grade non-ionic cleaning solution for conductivity cell (supplied in 100% strength; dilute as directed)	--
801542	AF24173 Anti-Foulant Device	bis(tributyltin) oxide device inserted into anti-foulant device cup; set of 2 Note: GPCTD uses only 1 Anti-Foulant Device; other one is spare.	1
30388	Tygon tube, ½ inch ID x ¾ inch OD	Main plumbing tubing	1
30579	Tygon tube, 3/8 inch ID x ½ inch OD	13 mm (0.5 in.) long pieces used on optional SBE 43F DO sensor intake & exhaust to fit to main plumbing	-

Appendix V: Manual Revision History

Manual Version	Date	Description
001	05/10	<ul style="list-style-type: none"> Initial release.
002	07/12	<ul style="list-style-type: none"> Firmware 1.1: Update power consumption specification for Slow Interval Sampling when real-time data is not being transmitted (consumes less power than previous firmware). Add stability specifications. Update SBE 43F drawing for current plenum. Add connector pinout drawings. Add information on oxygen sensor coefficients – all oxygen data is output in Hz, calibration coefficients are used to create .xmlcon file for post-processing in SBE Data Processing. Update SeatermV2 screen capture. Provide Tygon part number and size for plumbing. Update Triton website information. Update Unpacking section to remove computer/power supply cable. Add Declaration of Conformity. Correct typos.
003	01/13	<ul style="list-style-type: none"> Add CE mark to cover page. Add information about limitations with 115200 baud rate. Update software compatibility information. Clarify use of Send Last Sample command during autonomous sampling. Clarify that unpumped spot sampling is recommended for diagnostics only. Add cable and wiring diagrams. Fix typos.
004	09/13	<ul style="list-style-type: none"> Firmware 1.2.1: Add SetSampleNum= command. Change AutoRun=Y functioning; GPCTD now does not reset memory when power is removed. Add information that sampling continues if the FLASH memory is filled, but excess data is not stored to memory. Update SeatermV2 screen capture, Serial Port Configuration dialog box, and Upload dialog box. Update Declaration of Conformity.
005	02/15	<ul style="list-style-type: none"> Correct OutputFormat=2 in Command Summary appendix (output is decimal, not hex). Add information on PC settings for binary upload. Add caution regarding using Parker Super O Lube, not Parker O Lube (which is petroleum based). Remove <i>standard</i> and <i>optional</i> language related to GPCTD features. Add information on O-ring maintenance. Update language on where to find updated software on website. Switch to Sea-Bird Scientific cover.
006	06/16	<ul style="list-style-type: none"> Add previously undocumented command, OSN=, for setting oxygen sensor serial number (useful for identifying oxygen sensor if you swap them in the field). Update SeatermV2 main screen. Update Declaration of Conformity. Fix typos.
007	09/20	<ul style="list-style-type: none"> Updated composition of TBTO anti-foulant

Index

A

Anti-Foulant Device
 replacing · 54
 Anti-Foulant Devices · 62
 replacing · 53
 Autonomous sampling commands · 36

B

Batteries · 11
 Baud · 34
 Baud rate · 14

C

Cables · 13
 Calibration · 11, 55
 Calibration coefficients commands · 41
 CE certification · 3
 Circuitry · 59
 Cleaning · 52
 Command summary · 60
 Commands
 autonomous sampling · 36
 baud · 34
 calibration coefficients · 41
 communication · 34
 continuous sampling · 36
 data format · 34
 data upload · 38, 47
 date/time · 34
 descriptions · 26
 format · 34
 hardware configuration · 41
 interval sampling · 36
 output format · 34
 oxygen · 35
 polled sampling · 39
 pump · 35, 36
 pump on/off · 40
 setup · 34
 spot sampling · 39
 status · 27
 upload · 38, 47
 Communication commands · 34
 Communication defaults · 19
 Conductivity sensor
 maintenance · 52
 Conductivity sensor calibration · 55
 Connector maintenance · 51
 Connectors · 12
 Continuous sampling · 15
 Continuous sampling commands · 36
 Corrosion precautions · 51

D

Data bits · 14
 Data format · 34, 42
 Data I/O · 14
 Data processing · 47, 50
 Data storage · 11, 15
 Data upload · 47
 Data upload commands · 38
 Date/time commands · 34
 Declaration of Conformity · 3
 Deployment
 installation · 45
 optimizing data quality · 44
 Derive · 50
 Description · 8
 Dimensions · 12

E

End cap · 12, 51

F

Format · 34
 data · 42
 Functional description · 59

G

Glossary · 58
 Guard
 removal · 54

H

Hardware configuration · 41

I

Interval sampling · 15
 Interval sampling commands · 36

M

Maintenance · 51
 conductivity sensor · 52
 pressure sensor · 52
 Manual revision history · 67
 Memory · 11, 15
 Modes · *See* Sampling modes

O

Output format · 34
 Oxygen commands · 35
 Oxygen sensor
 maintenance · 52

P

Parity · 14
 Parker Super O-Lube · 58
 Parts
 replacement · 66
 Polled sampling commands · 39
 Power · 11
 Pressure sensor
 maintenance · 52
 Pressure sensor calibration · 55
 Processing data · 47
 Pump commands · 35, 36
 Pump on/off commands · 40

Q

Quick start · 6

R

Recovery
 physical handling · 46
 uploading data · 47
 Replacement parts · 66
 Revision history · 67
 RS-232 · 14

S

Sample timing · 15
 Sampling
 autonomous · 23
 continuous · 23
 fast interval · 23
 slow interval · 23
 Spot · 25
 Sampling commands · 36
 Sampling modes · 22
 SBE Data Processing · 10, 16, 50
 Sea Plot · 50
 Seasoft · 10, 16
 Seaterm V2 · 10
 Seaterm232 · 10, 16, 17, 47
 SeatermV2 · 16, 17, 47
 Sensor calibration · 55
 Sensors · 11
 Setup commands · 34
 Software · 10
 installation · 16
 Specifications · 11
 Spot sampling · 15
 Spot sampling commands · 39
 Status command · 27
 Stop bits · 14
 Storage · 52
 Super O-Lube · 58
 System description · 8

T

Temperature sensor calibration · 55
 Terminal program · 10, 16, 17, 47
 Test
 power and communications · 16
 setup · 16
 Timing · 15
 Triton · 58

U

Unpacking GPCTD · 7
 Upload commands · 38
 Uploading data · 47

V

Versions · 67

W

Wiring · 13